

# Sky Air

Product catalogue 2022  
for professionals



**SkyAir** A-series

**BLUEVOLUTION**

# Building a sustainable legacy together

Air surrounds us all the time, and in fact our very existence depends on it. At Daikin, the future of the world's indoor air is our greatest concern.

**Daikin** envisions a world with healthier indoor air while reducing our environmental impact. Driven by a dedication to achieve net zero CO<sub>2</sub> emissions by 2050, we provide **safe, healthy and comfortable spaces** throughout the building life cycle using **world-leading technology**.

Building on our **long-term partnerships**, let's build together now to achieve our goals, protecting the health and wellbeing of every individual.

---

## Supporting in decarbonization

We must act now to ensure we create a long-lasting legacy. As a company that values sustainability, we want to help to **decarbonize** buildings and create a **healthy** environment for generations to come.

Taking on the sustainable transformation, our solutions reduce the CO<sub>2</sub> footprint of buildings, whether they are new builds or renovations:

- Reducing CO<sub>2</sub> equivalents through **lower GWP refrigerants** such as R-32
- Maximizing sustainability over the entire life cycle, thanks to market-leading **real life seasonal efficiencies**
- Ensuring systems run efficiently 24/7 through **smart controls**
- **Safeguarding natural resources** - by reusing existing refrigerant through **L∞P Daikin**, turning waste into an asset

---

## Building for the future

As market leaders in total solutions, we are constantly innovating to offer you a **comfortable, healthy and safe** environment, meeting your needs. Reliability, support and precision are characteristics of our future-proof products and services. We offer:

- A **wide range** of next-generation heat pumps to meet complex demands, including **easy upgrading**
- Expert **indoor air quality solutions** through our ventilation and filtration systems to eliminate pollutants and balance humidity levels

---

## A journey we take together

Together we take on the sustainability journey. We provide expert **support** throughout the building life cycle and give **peace of mind** by ensuring what we do is **future-proof** and is helping to build a better future.

- Our team of **experts**, go beyond product support. Together we reach your green objectives.
- We are there for you, **all the time**: via our local customer support teams and e-commerce solutions.
- We're in it for the **long term**. We deliver what we commit to providing clear and trustworthy data.



# What's new?

## Wall mounted unit



**SkyAir**

p. 43



**NEW** FAA-B

- › New flat, stylish front panel
- › Combines with Sky Air Alpha-series (RZAG-N\*), Sky Air Advance-series (RZASG\*) and Sky Air Active-series (ARXM-R/AZAS\*)

## Astropure 2000 - Air Purifier for Commercial Applications

p. 106



**NEW** BR00000554, BR00000676, BR00000678

**Plug & play, mobile recirculation unit with high efficiency filtration – for better indoor air quality in commercial spaces**

- › For areas where additional, extra high, filtration performance is needed.
- › Airflow rate up to 2,000 m<sup>3</sup>/h
- › HEPA H14 filter in accordance with EN1822
- › Optional UV germicidal irradiation (UVGI)
- › Insulated double-wall construction provides whisper-quiet operation down to 35 dB(A)
- › Easy installation, operation, and maintenance in a totally self-contained system
- › For commercial areas up to 200m<sup>2</sup>

## Onecta app

p. 114



  
amazon alexa

 works with the  
Google Assistant

**NEW** BRP069C81 / C82

**Intuitive online and voice control functions**

- › Can integrate with Amazon Alexa and Google assistant voice control
- › Interfaces with home control systems
- › Easy scheduling, control and monitoring

# Table of contents

What's new?	4
7 reasons why Sky Air is unique in the market	8
Solution highlights	10
Indoor units	13
Outdoor units	57
Biddle air curtains	88
Commercial Ventilation & Air Purification	91
Control Systems	111
Options & accessories	141
Tools and platforms	151
Technical drawings	159

**SkyAir** Advance-series

**SkyAir** Alpha-series

Low height.  
High value.



✓ Unique, low-height single fan range

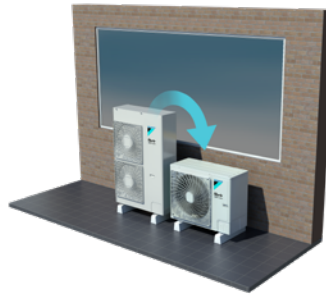

**SkyAir Alpha-series**  
RZAG71-100-125-140NV1/NY1

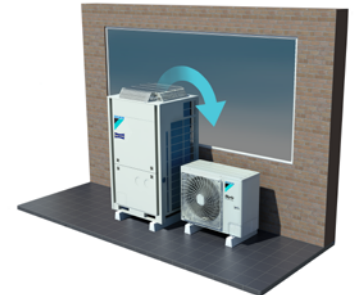

**SkyAir Advance-series**  
RZA200-250D

✓ Compact unit, easy to transport

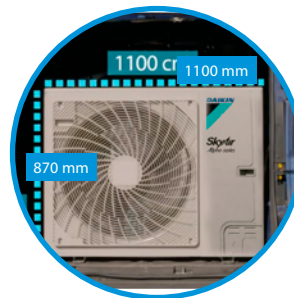

✓ Market-leading serviceability and handling



Fast and easy access to all critical component

- › Single screw access
- › Wider access area



Newly positioned handle for easier carrying

The smart way for  
sound  
reduction



  
-10 dB(A)!

## Daikin dedicated solution for sound reduction

Meet strict sound requirements, while increasing flexibility to apply Sky Air and VRV heat pumps thanks to sound power reduction of up to 10 dB(A).

- › **Guaranteed high performance:** optimised design to keep the capacity and air flow as close as possible to the standard conditions
- › **Faster and reliable planning:** no calculations or estimations necessary thanks to tested data according to ISO 3744
- › **Perfect fit:** specially designed for Sky Air and VRV heat pumps
- › **Maximum flexibility:** can be installed and retrofitted on any plain surface
- › **Easy access:** simple and fast installation and maintenance through large side panels with fast locks
- › **Designed to be discreet:** tailor-made low height design; highly aesthetic finishing and smooth surface in anthracite colour-tone



[www.daikin.eu/en\\_us/products/ekIn-a.html](http://www.daikin.eu/en_us/products/ekIn-a.html)



**SkyAir** **VRV**

# 7 reasons why Sky Air is unique in the market

1 Full Sky Air R-32 range delivering future-proofed, best-in-class climate control

**SkyAir A-series**

**BLUEEVOLUTION**

More details on page 58



System	Type	Model	Product name	35	50	60	71	100	125	140	200	250	
Air cooled	Heat pump	<b>SkyAir Alpha-series</b> - Industry leading technology for commercial applications - Dedicated solution for infrastructure cooling - Variable Refrigerant Temperature (RZAG71-100-125-140 series) - Maximum piping length up to 85m (50m for RZAG35-50-60) - Replacement technology - Extended operation range down to -20°C in both heating and cooling - Pair, twin, triple and double twin application (RZAG71-100-125-140 series)	<b>R-32</b> <b>A++</b> (A+++ - D)	RZAG-A									
		<b>SkyAir Advance-series</b> - Technology and comfort combined for commercial applications - Very compact and easy to install outdoor units - Maximum piping length up to 50m (RZA-D up to 100m) - Replacement technology - Operation range down to -15°C both cooling and in heating (RZA-D down to -20°C) - Pair, twin, triple and double twin application	<b>R-32</b> <b>A+</b> (A+++ - D)	RZASG-MV1/ MY1									
		<b>SkyAir Active-series</b> - Ideal solution for busy environments and small shops - Very compact and easy to install outdoor units - Maximum piping length up to 30m - Replacement technology - Easy-to-mount outdoor units: roof, terrace or wall - Exclusively offered for pair applications	<b>R-32</b> <b>A</b> (A+++ - D)	ARXM-R AZAS-MV1/ MY1									

## Full indoor line up

(over 45 different models)





## 2 High energy efficiency

- › **Top seasonal efficiency**
  - › SEER up to 8.02 and A+++ label in cooling and heating
  - › Variable Refrigerant Temperature that automatically adapts the refrigerant temperature to the load
- › Round flow and concealed ceiling units with **auto cleaning filter**

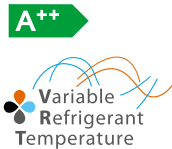

## 3 Best comfort

- › **Variable Refrigerant Temperature** preventing cold draughts
- › **Low sound** indoor and outdoor units
- › **Presence and floor sensors** direct the air flow away from persons, while ensuring an even temperature distribution
- › Operation down to **-20°C in heating and cooling** operation
- › Fresh air intake integrated in indoor unit

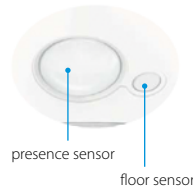

## 4 Top reliability

- › For **infrastructure cooling**
  - › unique boosted capacity indoor unit systems
  - › duty rotation control
- › **Refrigerant cooled PCB**
- › New refrigerant passes keeping heat exchanger and drain holes completely open at all times
- › **Most extensive testing** before new units leave the factory
- › **Widest support network** and after sales service
- › All spare parts available in Europe



bottom plate refrigerant pass

## 5 Market leading controls

- › **Remote connectivity**
  - › **Intuitive app** control
  - › **Daikin Cloud Service** offering online control, energy monitoring and comparison of multiple sites
- › **User-friendly wired remote controller with premium design**
  - › Intuitive touch button control
  - › 3 color versions
  - › Advanced settings can be easily done via your smartphone
- › **Dedicated control solutions**
  - › for retail applications
  - › for infrastructure cooling



## 6 Superior aesthetics

- › **Fully flat cassette** design unit that integrates fully flat into the ceiling
- › **Auto cleaning** units ensure dirt-free ceilings with high efficiency filters for regular and dust prone areas
- › Widest ever range cassette panels
  - › Available in **white and black**
  - › Sleek **designer panel** range

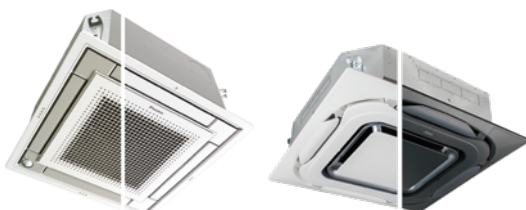

## 7 Unique installation benefits

- › **4-way blow ceiling suspended cassette (FUA)** for rooms without false ceiling.
- › Plug & play Daikin air handling unit with ERQ condensing units
- › Reliably replace Daikin and non-Daikin systems without the need for pipe cleaning thanks to the new hepta filtration
- › Dedicated low sound enclosure, reducing sound power up to -10 dB(A)
- › Use up to 4 indoor units linked to one outdoor unit for long or irregularly shaped rooms





# Shops

reducing retail costs

- › Open door trading thanks to Biddle air curtains
- › Discreet with limited visual and operating impact
- › Reduces energy usage and costs
- › Worry-free installation
- › User-friendly control
- › Air purification ensuring a clean, healthy environment for your customers

*"We were very happy to work with Daikin in installing one of the latest fully controllable systems with operational flexibility, which met all our requirements."*

Retail shop representative



Shops



# Offices

Efficiency in the workplace

- › Fully flat cassette: Design and genius in one
- › Cutting the cost of hot water
- › Fresh air: A healthier office atmosphere
- › Centralised control: Complete Daikin package for office building management

*"Leading edge design in harmony with the construction and interior design."*

Architect



Office





## Restaurants

Perfect ambiance for dining

- › Ensures an even temperature distribution to create the perfect dining environment
- › Heat recovery ventilation keeps the air clean
- › Highly energy efficient
- › Uses intelligent control systems operated from one central location
- › Air purification ensuring a clean, healthy environment for your customers

*“Total renovation and expansion of the restaurant meant new air conditioning equipment was required. Daikin was the first and only supplier to contact as we had already had good experience in the past!”*

Owner of a highly-rated restaurant



## IT rooms, laboratories and telecom shelters

Sky Air for infrastructure cooling

- › Continuous cooling operation
- › Dedicated infrastructure cooling settings
- › Unique selection method with capacity tables down to -20°C outdoor temperature
- › Enhanced **reliability** thanks to **assymetric combinations** (e.g. 125 class indoor + 100 class outdoor)

*“A reliable system and guaranteed continuous operation are what count for me.”*

General office manager











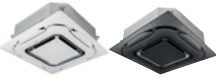

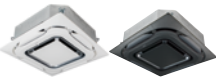

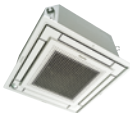

Sky Air, from high specification, tailored solutions to primary cooling and heating

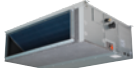
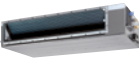
# Indoor Units

	Products overview indoor units	14
	Benefits overview indoor units	16
	Ceiling mounted cassettes	20
<b>UNIQUE</b>	FCAHG-H	23
<b>UNIQUE</b>	FCAG-B	24
<b>UNIQUE</b>	FFA-A9	30
	Concealed ceiling units	32
<b>UNIQUE</b>	Auto cleaning filter for concealed ceiling units	32
	Multi zoning kit	33
	FDXM-F9	34
	FBA-A(9)	36
	FDA125A	40
	FDA200-250A	41
	ADEA-A	42
	Wall mounted units	43
<b>NEW</b>	FAA-B	43
	FTXM-R	46
	Ceiling suspended units	47
	FHA-A(9)	47
<b>UNIQUE</b>	FUA-A	50
	Floor standing units	52
	FVA-A	52
	Concealed floor standing units	54
	FNA-A9	54

# Product overview *SkyAir*

Type	Model	Product name	PG	
Ceiling mounted cassette	<b>UNIQUE</b> High COP, Round flow cassette	FCAHG-H	23	 <p>360° air discharge for the highest efficiency and comfort</p> <ul style="list-style-type: none"> <li>- High COP cassette ensures top performance for commercial applications</li> <li>- Auto cleaning function ensures high efficiency</li> <li>- Intelligent sensors save energy and maximize comfort</li> <li>- Flexibility to suit every room layout</li> <li>- Widest choice ever in decoration panel designs and colors</li> </ul> 
	<b>UNIQUE</b> Round flow cassette	FCAG-B	24	 <p>360° air discharge for the highest efficiency and comfort</p> <ul style="list-style-type: none"> <li>- Auto cleaning function ensures high efficiency</li> <li>- Intelligent sensors save energy and maximize comfort</li> <li>- Flexibility to suit every room layout</li> <li>- Lowest installation height in the market</li> <li>- Widest choice ever in decoration panel designs and colors</li> </ul> 
	<b>UNIQUE</b> Fully flat cassette	FFA-A9	30	 <p>Unique design in the market that integrates fully flat into the ceiling</p> <ul style="list-style-type: none"> <li>- Perfect integration in standard architectural ceiling tiles</li> <li>- Blend of iconic design and engineering excellence with a white or silver and white finish</li> <li>- Intelligent sensors save energy and maximize comfort</li> <li>- Flexibility to suit every room layout without changing the location of the unit!</li> <li>- Quietest 600 x 600 cassette on the market</li> </ul>
Concealed ceiling	Slim concealed ceiling unit	FDXM-F9	34	 <p>Slim design for flexible installation</p> <ul style="list-style-type: none"> <li>- Compact dimensions enable installation in narrow ceiling voids</li> <li>- Medium external static pressure up to 40Pa</li> <li>- Small capacity unit developed for small of well insulated rooms</li> <li>- Auto cleaning function ensures high efficiency and reliability</li> </ul>
	Concealed ceiling unit with medium ESP	FBA-A(9)	36	 <p>Slimmest yet most powerful medium static pressure unit on the market!</p> <ul style="list-style-type: none"> <li>- Slimmest unit in class, only 245mm</li> <li>- Low operating sound level</li> <li>- Medium external static pressure up to 150Pa facilitates using flexible ducts of varying lengths</li> <li>- Automatic air flow adjustment function measures the air volume and static pressure and adjusts it towards the nominal air flow, guaranteeing comfort</li> </ul>
	Concealed ceiling unit with high ESP	FDA-A	40	 <p>ESP up to 200Pa, ideal for large sized buildings</p> <ul style="list-style-type: none"> <li>- Discretely concealed in the ceiling: only the grilles are visible</li> <li>- Possibility to change ESP via wired remote control allows optimisation of the supply air volume</li> <li>- Flexible installation as the air suction direction can be altered from rear to bottom suction</li> </ul>
		FDA200-250A	41	 <p>ESP up to 250Pa, ideal for extra large sized spaces</p> <ul style="list-style-type: none"> <li>- Discretely concealed in the ceiling: only the grilles are visible</li> <li>- Possibility to change ESP via wired remote control allows optimisation of the supply air volume</li> </ul>
	Concealed ceiling unit	ADEA-A	42	 <p>Ideal for residential applications with false ceilings</p> <ul style="list-style-type: none"> <li>- Energy label up to A</li> <li>- Medium external static pressure up to 150Pa facilitates using flexible ducts of varying lengths</li> <li>- Slimmest unit in class, only 245mm</li> <li>- Exclusively offered for pair applications</li> </ul>
Wall mounted	<b>NEW</b> Wall mounted unit	FAA-B	43	 <p>For rooms with no false ceilings nor free floor space</p> <ul style="list-style-type: none"> <li>- Flat, stylish front panel</li> <li>- The air is comfortably spread up- and downwards thanks to 5 different discharge angles</li> <li>- Easy maintenance as this can be done from the front of the unit</li> <li>- Flexible to install: pipe connection can be bottom, left or right</li> </ul>
	Perfera wall mounted unit	FTXM-R	46	 <p>For rooms with no false ceilings nor free floor space</p> <ul style="list-style-type: none"> <li>- Practically inaudible</li> <li>- 2 area motion detection sensor</li> <li>- Flash streamer technology</li> <li>- 3D air flow</li> </ul>
Ceiling suspended	Ceiling suspended unit	FHA-A(9)	47	 <p>For wide rooms with no false ceilings nor free floor space</p> <ul style="list-style-type: none"> <li>- Ideal for comfortable air flow in wide rooms thanks to Coanda effect</li> <li>- Even rooms with ceilings up to 3.8m can be heated up or cooled down very easily!</li> <li>- Can be mounted in corners or narrow spaces without any problem</li> </ul>
	<b>UNIQUE</b> 4-way blow ceiling suspended unit	FUA-A	50	 <p>Unique Daikin unit for high rooms with no false ceilings nor free floor space</p> <ul style="list-style-type: none"> <li>- Even rooms with ceilings up to 3.5m can be heated up or cooled down very easily!</li> <li>- Flexibility to suit every room layout without changing the location of the unit!</li> <li>- Optimum comfort guaranteed with automatic air flow adjustment to the required load</li> <li>- The air is comfortably spread up- and downwards thanks to 5 different discharge angles</li> </ul>
Floor standing	Floor standing unit	FVA-A	52	 <p>For spaces with high ceilings</p> <ul style="list-style-type: none"> <li>- Ideal solution for commercial spaces with no or narrow false ceilings</li> <li>- Even rooms with very high ceilings can be heated up or cooled down very easily!</li> <li>- Guarantees a stable temperature</li> <li>- Vertical and horizontal outblow</li> </ul>
	Concealed floor standing unit	FNA-A9	54	 <p>Designed to be concealed in walls, only grilles remain visible</p> <ul style="list-style-type: none"> <li>- Slimmest unit on the market with a depth of only 200mm!</li> <li>- Both window sill or ducted installation are possible thanks to sufficient ESP</li> <li>- Whisper quiet operation allows installation in any location</li> </ul>

# Full R-32 BLUEEVOLUTION line up

Indoor units



Capacity class											Outdoor unit combination				
											R-32				
25	35	50	60	71	100	125	140	200	250	SkyAir Alpha-series		SkyAir Advance-series		SkyAir Active-series	
										RZAG-A	RZAG-NV1/NY1	RZASG*	RZA-D	ARXM*/AZAS*	
					•	•	•	•				✓			
	•	•	•	•	•	•	•				✓	✓	✓	✓	
•	•	•	•								✓	✓	✓		
•	•	•	•								✓	✓	✓		
	•	•	•	•	•	•	•				✓	✓	✓	✓	
						•						✓	✓		
								•	•				✓		
				•	•	•								✓	
				•	•							✓	✓	✓	
	•	•	•								✓				
	•	•	•	•	•	•	•				✓	✓	✓		
				•	•	•						✓	✓		
				•	•	•	•					✓	✓		
•	•	•	•								✓	✓	✓		

# Benefit overview *SkyAir*

We care		Home leave operation	Maintains the indoor temperature at your specified comfort level during absence, thus saving energy.
		Fan only	The unit can be used as fan, blowing air without heating or cooling.
		Auto cleaning filter	The filter automatically cleans itself. Simplicity of upkeep means optimum energy efficiency and maximum comfort without the need for expensive or time-consuming maintenance.
		Presence & floor sensor	The presence sensor directs the air away from any person detected in the room, when the air flow control is on. The floor sensor detects the average floor temperature and ensures an even temperature distribution between ceiling and floor.
Comfort		Draught prevention	When starting to warm up or when the thermostat is off, the air discharge direction is set horizontally and the fan to low speed, to prevent draught. After warming up, air discharge and fan speed are set as desired.
		Whisper quiet	Daikin indoor units are whisper quiet. Also the outdoor units are guaranteed not to disturb the quiet of the neighbourhood.
		Auto cooling-heating changeover	Automatically selects cooling or heating mode to achieve the set temperature.
Air treatment		Air filter	Removes airborne dust particles to ensure a steady supply of clean air.
Humidity control		Dry programme	Allows humidity levels to be reduced without variations in room temperature.
Air flow		Ceiling soiling prevention	Prevents air from blowing out too long in horizontal position, to prevent ceiling stains.
		Vertical auto swing	Possibility to select automatic vertical moving of the air discharge louvre, for uniform air flow and temperature distribution.
		Fan speed steps	Allows to select up to the given number of fan speed.
		Individual flap control	Individual flap control via the wired remote controller enables you to easily fix the position of each flap individually, to suit any new room configuration. Optional closure kits are available as well.
Remote control & timer		Onecta app	Control your indoor climate from any location via smartphone or tablet.
		Weekly timer	Can be set to start heating or cooling anytime on a daily or weekly basis.
		Infrared remote control	Starts, stops and regulates the air conditioner from a distance.
		Wired remote control	Starts, stops and regulates the air conditioner.
		Centralised control	Starts, stops and regulates several air conditioners from one central point.
		Multi zoning	Allows up to 6 individual climate zones with one indoor unit
Other functions		Infrastructure cooling	Remove in a reliable, efficient and flexible way the heat constantly generated by the IT and server equipment to ensure maximum uptime while offering the best return on investment.
		Auto-restart	The unit restarts automatically at the original settings after power failure.
		Self-diagnosis	Simplifies maintenance by indicating system faults or operating anomalies.
		Drain pump kit	Facilitates condensation draining from the indoor unit.
		Twin/triple/double twin application	2,3 or 4 indoor units can be connected to only a single outdoor unit even if they have different capacities. All indoor units operate within the same heating or cooling mode from one remote control.
		Multi model application	Up to 5 indoor units can be connected to a single outdoor unit, even if they have different capacities. All indoor units can individually be operated within the same heating or cooling mode.
		VRV for residential application	Up to 9 indoor units (even different capacities and up to 71 class) can be connected to a single outdoor unit. All indoor units can individually be operated within the same mode.









WALL MOUNTED UNIT



CEILING SUSPENDED UNIT



ROUND FLOW CASSETTE, DESIGNER PANEL

# Round flow cassette

## 360° air discharge for improved comfort

- > Industry-first and proven design.
- > Wider flaps to even further improve equal temperature distribution

## More energy efficient and user-friendly than any other cassette

- > Running costs can be reduced down to 50% compared with standard solutions
- > Automatic filter cleaning.
- > Less time is required to maintain the filter: dust can be removed easily with a vacuum cleaner without opening the unit.

## Intelligent sensors improve efficiency and comfort even more

- > The presence sensor adjusts the set point if no one is detected in the room leading to up to 27% savings.
- > It also automatically directs air flow away from any person to avoid draught.
- > The infrared floor sensor detects the average floor temperature and ensures even temperature distribution between ceiling and floor to prevent cold feet.

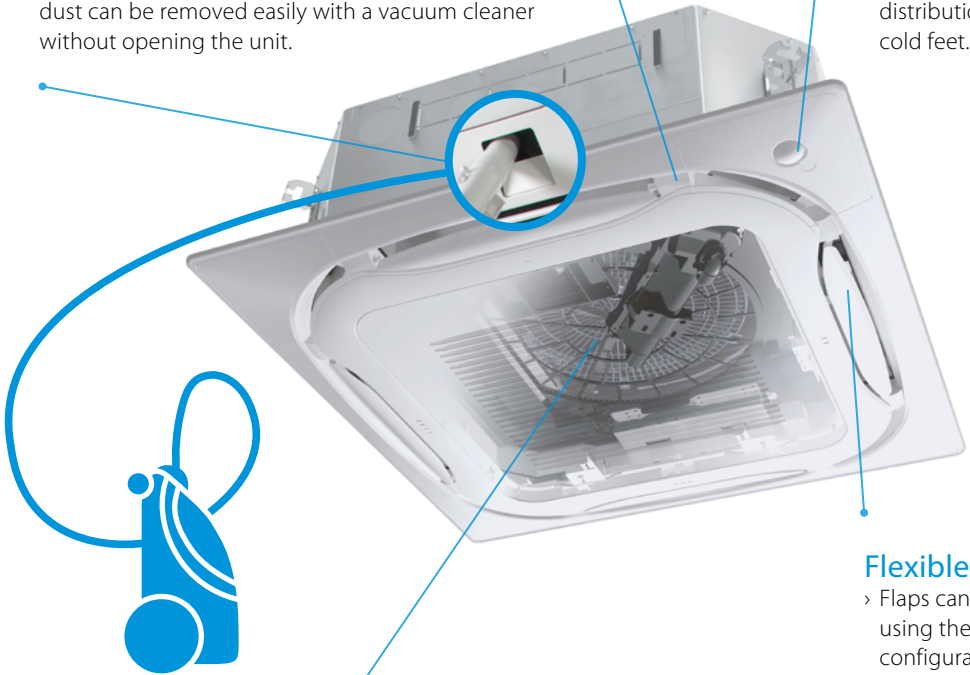
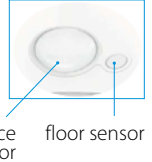

## Flexible installation

- > Flaps can be individually controlled or closed using the wired remote control, to suit room configuration. Optional closure kits are also available.

## Auto cleaning filter

Dust can simply be removed using a vacuum cleaner without opening the unit.

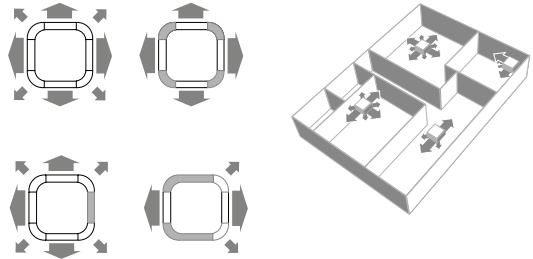
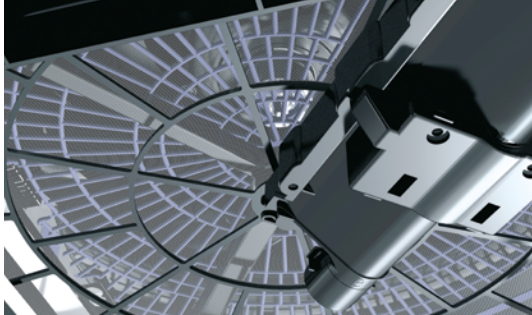

\* Available as an option

# Widest ever range of decoration panels to fit the interior and application

## Standard panels available in white and black

› The unique Daikin round flow cassette with 360° air flow, wide flaps and optional intelligent sensors



BYCQ140E  
White standard panel



BYCQ140EW  
Full white standard panel



BYCQ140EB  
Black standard panel

## Auto cleaning panels available in white and black

› The unique Daikin auto cleaning cassette with wide flaps and optional intelligent sensors



BYCQ140EGF  
White auto cleaning panel



BYCQ140EGFB  
Black auto cleaning panel

## Designer panel in white and black

› New line of design panels hiding air intake grilles for a more stylized outlook  
› With 360° air flow, wide flaps and optional intelligent sensors



White BYCQ140EP  
White designer panel



BYCQ140EPB  
Black designer panel



ROUND FLOW CASSETTE, BLACK DESIGNER PANEL



ROUND FLOW CASSETTE AUTO CLEANING PANEL WITH FINE MESH FILTER



# High COP, round flow cassette

360° air discharge for optimum efficiency and comfort

- › Combination with Sky Air Alpha-series ensures best in class quality, highest efficiency and performance
- › High COP cassette ensures top performance and great energy savings
- › Optional automatic filter cleaning panel results in higher efficiency & comfort and lower maintenance costs. 2 filters available: standard filter and finer mesh filter
- › Two optional intelligent sensors improve energy efficiency and comfort
- › Individual flap control: flexibility to suit every room layout without changing the location of the unit!
- › Widest choice ever in decoration panels: designer panels in white (RAL9010) and black (RAL9005) and standard panels in white (RAL9010) with grey louvers or full white
- › Bigger flaps and unique swing pattern improve equal air distribution
- › 5 different fan speeds available for maximum comfort
- › Optional fresh air intake
- › Branch duct discharge allows to optimize air distribution in irregular shaped rooms or to supply air to small adjacent rooms
- › Standard drain pump with 675mm lift increases flexibility and installation speed



More details and final information can be found by scanning or clicking the QR codes.



FCAHG-H



RZAG-NV1



RZAG-NY1

Efficiency data		FCAHG + RZAG		71H + 71NY1	100H + 100NY1	125H + 125NY1	140H + 140NY1	71H + 71NY1	100H + 100NY1	125H + 125NY1	140H + 140NY1		
Cooling capacity	Nom.	kW		6.80	9.50	12.1	13.4	6.80	9.50	12.1	13.4		
Heating capacity	Nom.	kW		7.50	10.8	13.5	15.5	7.50	10.8	13.5	15.5		
Space cooling	Energy efficiency class			A++		-		A++		-			
	Capacity	Pdesign	kW	6.80	9.50	12.1	13.4	6.80	9.50	12.1	13.4		
	SEER			7.90	7.70	8.02	7.93	7.90	7.70	8.02	7.93		
	ηs,c		%	-	-	318	314	-	-	318	314		
Space heating (Average climate)	Annual energy consumption		kWh/a	301	432	905	1,014	301	432	905	1,014		
	Energy efficiency class			A++		-		A+		A++			
	Capacity	Pdesign	kW	4.70	-	9.52	-	4.70	-	9.52	-		
	SCOP/A			4.61	4.75	4.53	4.44	4.56	4.75	4.53	4.44		
	ηs,h		%	-	-	178	175	-	-	178	175		
Annual energy consumption		kWh/a	1,427	2,805	2,943	3,002	1,443	2,805	2,943	3,002			
Indoor unit		FCAHG		71H	100H	125H	140H	71H	100H	125H	140H		
Dimensions	Unit	HeightxWidthxDPTH		mm									
				288 x840 x840									
Weight	Unit			kg									
				25.0									
Air filter	Type			Resin net									
Decoration panel	Model			Standard panels: BYCQ140E - white with grey louvers / BYCQ140EW - full white / BYCQ140EB - black Auto cleaning panels: BYCQ140EGF - white / BYCQ140EGFB - black Designer panels: BYCQ140EP - white / BYCQ140EPB - black									
				Standard panels: 65x950x950 / Auto cleaning panels: 148x950x950 / Designer panels: 106x950x950									
				Standard panels: 5.5 / Auto cleaning panels: 10.3 / Designer panels: 6.5									
Fan	Air flow	Cooling	Low/Medium/High	m³/min	13.7/18.8/23.6	19.1/25.7/32.2	21.2/27.3/34.4		13.7/18.8/23.6	19.1/25.7/32.2	21.2/27.3/34.4		
	rate	Heating	Low/Medium/High	m³/min	13.7/18.8/23.6	18.3/24.6/30.8	19.7/25.5/32.1		13.7/18.8/23.6	18.3/24.6/30.8	19.7/25.5/32.1		
Sound power level	Cooling			dBA	53.0	61.0		53.0	61.0				
	Heating			dBA	53.0	61.0		53.0	61.0				
Sound pressure level	Cooling	Low/Medium/High			dBA	29.0/33.0/36.0	33.0/39.0/44.0	35.0/40.0/45.0	29.0/33.0/36.0	33.0/39.0/44.0	35.0/40.0/45.0	37.0/41.0/45.0	
	Heating	Low/Medium/High			dBA	29.0/33.0/36.0	33.0/39.0/44.0	35.0/40.0/45.0	29.0/33.0/36.0	33.0/39.0/44.0	35.0/40.0/45.0	37.0/41.0/45.0	
Control systems	Infrared remote control		BRC7FA532F / BRC7FB532F / BRC7FA532FB / BRC7FB532FB										
	Wired remote control		BRC1H52W/S/K / BRC1E53A / BRC1E53B / BRC1E53C / BRC1D52										
Power supply	Phase/Frequency/Voltage		Hz/V										
			1~/50/60/220-240/220										
Outdoor unit		RZAG		71NV1	100NV1	125NV1	140NV1	71NY1	100NY1	125NY1	140NY1		
Dimensions	Unit	HeightxWidthxDPTH		mm									
				870 x1,100 x460									
Weight	Unit			kg									
				81	85	95		81	85	94			
Sound power level	Cooling			dBA	64	66	69	70	64	66	69	70	
	Heating			dBA	-	-	68	71	-	-	68	71	
Sound pressure level	Cooling	Nom.			dBA	46	47	49	50	46	47	49	50
	Heating	Nom.			dBA	48	50	52		48	50	52	
Operation range	Cooling	Ambient	Min.~Max.			°CDB							
	Heating	Ambient	Min.~Max.			°CWB							
						-20 ~52							
						-20 ~18							
Refrigerant	Type/GWP		R-32/675										
	Charge			kg/TCO2Eq		3.20 /2.16		3.70 /2.50		3.20 /2.16		3.70 /2.50	
Piping connections	Liquid/Gas OD		mm										
			9.52 /15.9										
	Piping length	OU - IU	Max.	m		55		75		85		100	
		System	Equivalent	m		75		75		85		100	
			Chargeless	m		40		40		40		40	
	Additional refrigerant charge		kg/m										
	Level difference IU - OU		Max.		m								
					30								
Power supply	Phase/Frequency/Voltage		Hz/V										
					1~/50 /220-240				3~/50 /380-415				
Current - 50Hz	Maximum fuse amps (MFA)		A		20		32		16		16		

Contains fluorinated greenhouse gases



# Round flow cassette

## 360° air discharge for optimum efficiency and comfort

- › Combination with Sky Air Alpha-series ensures best in class quality, highest efficiency and performance
- › Optional automatic filter cleaning panel results in higher efficiency & comfort and lower maintenance costs. 2 filters available: standard filter and finer mesh filter
- › Two optional intelligent sensors improve energy efficiency and comfort
- › Individual flap control: flexibility to suit every room layout without changing the location of the unit!
- › Lowest installation height in the market: 214mm for class 20-63
- › Widest choice ever in decoration panels: designer panels in white (RAL9010) and black (RAL9005) and standard panels in white (RAL9010) with grey louvers or full white
- › Bigger flaps and unique swing pattern improve equal air distribution
- › 5 different fan speeds available for maximum comfort
- › Optional fresh air intake
- › Branch duct discharge allows to optimize air distribution in irregular shaped rooms or to supply air to small adjacent rooms
- › Standard drain pump with 675mm lift increases flexibility and installation speed



More details and final information can be found by scanning or clicking the QR codes.



FCAG-B



RZAG-A



RZAG-NV1



RZAG-NY1

Efficiency data		FCAG + RZAG												
		35B + 35A	50B + 50A	60B + 60A	71B + 71NV1	100B + 100NV1	125B + 125NV1	140B + 140NV1	71B + 71NY1	100B + 100NY1	125B + 125NY1	140B + 140NY1		
Cooling capacity	Min./Nom./Max.	kW												
Heating capacity	Min./Nom./Max.	kW												
Space cooling	Energy efficiency class	A++												
	Capacity	Pdesign	kW											
	SEER													
	ηs,c		%											
	Annual energy consumption		kWh/a											
Space heating (Average climate)	Energy efficiency class	A+												
	Capacity	Pdesign	kW											
	SCOP/A													
	ηs,h		%											
	Annual energy consumption		kWh/a											
Indoor unit		FCAG	35B	50B	60B	71B	100B	125B	140B	71B	100B	125B	140B	
Dimensions	Unit	HeightxWidthxDepth	mm				246 x840 x840		204 x840 x840		246 x840 x840			
Weight	Unit		kg		21		23		21		23			
Air filter	Type	Resin net												
Decoration panel	Modelk	Standard panels: BYCQ140E - white with grey louvers / BYCQ140EW - full white / BYCQ140EB - black Auto cleaning panels: BYCQ140EGF - white / BYCQ140EGB - black Designer panels: BYCQ140EP - white / BYCQ140EPB - black												
Fan	Dimensions	HeightxWidthxDepth	mm											
	Weight		kg											
	Air flow rate	Cooling Low/Medium/High	Heating Low/Medium/High	m <sup>3</sup> /min										
Sound power level	Cooling		dBA											
	Heating		dBA											
Sound pressure level	Cooling	Low/Medium/High	dBA											
	Heating	Low/Medium/High	dBA											
Control systems	Infrared remote control	BRC7FA532F / BRC7FB532F / BRC7FA532FB / BRC7FB532FB												
	Wired remote control	BRC1D528 / BRC1E53A7 / BRC1E53B7 / BRC1E53C7 / BRC1H81W/S / BRC1H51(9)W/S/K / BRC2E52C7 / BRC3E52C7												
Power supply	Phase/Frequency/Voltage	Hz/V												
Outdoor unit		RZAG	35A	50A	60A	71NV1	100NV1	125NV1	140NV1	71NY1	100NY1	125NY1	140NY1	
Dimensions	Unit	HeightxWidthxDepth	mm				81		85		81		85	
Weight	Unit		kg		81		85		95		81		85	
Sound power level	Cooling		dBA											
	Heating		dBA											
Sound pressure level	Cooling	Nom.	dBA											
	Heating	Nom.	dBA											
Operation range	Cooling	Ambient	Min.~Max.										-20 ~52	
	Heating	Ambient	Min.~Max.										-20 ~18	
Refrigerant	Type/GWP	R-32/675.0												
	Charge		kg/TCO2Eq		3.20 /2.16		3.70 /2.50		3.20 /2.16		3.70 /2.50			
Piping connections	Liquid/Gas	OD	mm		6.35 /9.50		6.35 /12.7		9.52 /15.9		9.52 /15.9			
	Piping length	OU - IU	Max.	m		55		85		55		85		
		System	Equivalent	m		75		100		75		100		
			Chargeless	m		30		40		30		40		
		Additional refrigerant charge		kg/m		0.02 (for piping length exceeding 30m)		See installation manual		30		30		
Power supply	Phase/Frequency/Voltage	Hz/V												
Current - 50Hz	Maximum fuse amps (MFA)	A												

Contains fluorinated greenhouse gases





# Round flow cassette

## 360° air discharge for optimum efficiency and comfort

- › Combination with Sky Air Advance-series ensures good value for money for all types of commercial applications
- › Optional automatic filter cleaning panel results in higher efficiency & comfort and lower maintenance costs.
- › Two optional intelligent sensors improve energy efficiency and comfort
- › Widest choice ever in decoration panels: designer panels in white (RAL9010) and black (RAL9005) and standard panels in white (RAL9010) with grey louvers or full white
- › Bigger flaps and unique swing pattern improve equal air distribution
- › Individual flap control: flexibility to suit every room layout without changing the location of the unit!
- › Optional fresh air intake
- › Branch duct discharge allows to optimize air distribution in irregular shaped rooms or to supply air to small adjacent rooms
- › Standard drain pump with 675mm lift increases flexibility and installation speed



More details and final information can be found by scanning or clicking the QR codes.



FCAG-B



RZASG-MV1



RZASG-MY1

Efficiency data		FCAG + RZASG		71B + 71MV1	100B + 100MV1	125B + 125MV1	140B + 140MV1	100B + 100MY1	125B + 125MY1	140B + 140MY1
Cooling capacity	Nom.	kW		6.80	9.50	12.1	13.4	9.50	12.1	13.4
Heating capacity	Nom.	kW		7.50	10.8	13.5	15.5	10.8	13.5	15.5
Space cooling	Energy efficiency class		A++				A++			
	Capacity	Pdesign		kW	6.80	9.50	12.1	13.4	9.50	12.1
	SEER			6.47	6.55	5.76	6.53	6.55	5.76	6.53
	ηs,c			%	-	227	258	-	227	258
	Annual energy consumption			kWh/a	368	507	1,261	1,231	507	1,261
Space heating	Energy efficiency class		A+				A+			
(Average climate)	Capacity	Pdesign		kW	4.50	6.00	7.80	6.00	7.80	
	SCOP/A			4.10	4.17	4.05	4.31	4.17	4.05	4.31
	ηs,h			%	-	159	169	-	159	169
	Annual energy consumption			kWh/a	1,537	2,016	2,074	2,534	2,016	2,074
<b>Indoor unit</b>		<b>FCAG</b>		<b>71B</b>	<b>100B</b>	<b>125B</b>	<b>140B</b>	<b>100B</b>	<b>125B</b>	<b>140B</b>
Dimensions	Unit	HeightxWidthxDepth		mm		204 x840 x840		246 x840 x840		
Weight	Unit			kg		21		23		
Air filter	Type							Resin net		
Decoration panel	Model							Standard panels: BYCQ140E - white with grey louvers / BYCQ140EW - full white / BYCQ140EB - black Auto cleaning panels: BYCQ140EGF - white / BYCQ140EGFB - black Designer panels: BYCQ140EP - white / BYCQ140EPB - black		
	Dimensions	HeightxWidthxDepth		mm		Standard panels: 65x950x950 / Auto cleaning panels: 148x950x950 / Designer panels: 106x950x950		Standard panels: 5.5 / Auto cleaning panels: 10.3 / Designer panels: 6.5		
	Weight			kg						
Fan	Air flow rate	Cooling	Low/Medium/High	m³/min	10.8 /13.0 /15.1	13.0 /17.8 /22.7	13.1 /20.4 /27.2	13.0 /17.8 /22.7	13.1 /20.4 /27.2	
	Heating	Low/Medium/High		m³/min	10.8 /12.9 /15.1	13.2 /18.1 /23.0	13.0 /20.2 /27.0	13.2 /18.1 /23.0	13.0 /20.2 /27.0	
Sound power level	Cooling			dBA	51.0	54.0	58.0	54.0	58.0	
	Heating			dBA	51.0	54.0	58.0	54.0	58.0	
Sound pressure level	Cooling	Low/Medium/High		dBA	28.0 /31.0 /35.0	29.0 /33.0 /37.0	29.0 /35.0 /41.0	29.0 /33.0 /37.0	29.0 /35.0 /41.0	
	Heating	Low/Medium/High		dBA	28.0 /31.0 /33.0	29.0 /33.0 /37.0	29.0 /35.0 /41.0	29.0 /33.0 /37.0	29.0 /35.0 /41.0	
Control systems	Infrared remote control							BRC7FA532F / BRC7FB532F / BRC7FA532FB / BRC7FB532FB		
	Wired remote control							BRC1H52W/S/K / BRC1E53A / BRC1E53B / BRC1E53C / BRC1D52		
Power supply	Phase/Frequency/Voltage							1~/50/60/220-240/220		
<b>Outdoor unit</b>		<b>RZASG</b>		<b>71MV1</b>	<b>100MV1</b>	<b>125MV1</b>	<b>140MV1</b>	<b>100MY1</b>	<b>125MY1</b>	<b>140MY1</b>
Dimensions	Unit	HeightxWidthxDepth		mm		770 x900 x320		990 x940 x320		
Weight	Unit			kg		60		70		77
Sound power level	Cooling			dBA		65		70		73
	Heating			dBA		-		71		73
Sound pressure level	Cooling	Nom.		dBA	46	53	54	53	54	
	Heating	Nom.		dBA	47		57			
Operation range	Cooling	Ambient	Min.~Max.	°CDB			-15 ~46			
	Heating	Ambient	Min.~Max.	°CWB			-15 ~15.5			
Refrigerant	Type/GWP							R-32/675		
	Charge			kg/TCO2Eq		2.45 /1.65		2.60 /1.76		2.90 /1.96
Piping connections	Liquid/Gas	OD		mm				9.52 /15.9		
	Piping length	OU - IU	Max.	m			50			
	System	Equivalent		m			70			
	Chargeless			m			30			
	Additional refrigerant charge			kg/m				See installation manual		
	Level difference	IU - OU	Max.	m			30.0			
Power supply	Phase/Frequency/Voltage							1~/50 /220-240		3~/50 /380-415
Current - 50Hz	Maximum fuse amps (MFA)			A		20		25		32
										16

Contains fluorinated greenhouse gases



# Round flow cassette

360° air discharge for optimum efficiency and comfort

- › Ideal solution for small businesses and shops
- › Optional automatic filter cleaning panel results in higher efficiency & comfort and lower maintenance costs. 2 filters available: standard filter and finer mesh filter
- › Two optional intelligent sensors improve energy efficiency and comfort
- › Widest choice ever in decoration panels: designer panels in white (RAL9010) and black (RAL9005) and standard panels in white (RAL9010) with grey louvers or full white
- › Individual flap control: flexibility to suit every room layout without changing the location of the unit!
- › Bigger flaps and unique swing pattern improve equal air distribution
- › Optional fresh air intake
- › Branch duct discharge allows to optimize air distribution in irregular shaped rooms or to supply air to small adjacent rooms
- › Standard drain pump with 675mm lift increases flexibility and installation speed



More details and final information can be found by scanning or clicking the QR codes.



FCAG-B



ARXM-R



AZAS-MV1



AZAS-MY1

Efficiency data		FCAG + ARXM / AZAS		71B + ARXM71R	100B + AZAS100MV1	125B + AZAS125MV1	140B + AZAS140MV1	100B + AZAS100MY1	125B + AZAS125MY1	140B + AZAS140MY1	
Cooling capacity	Nom.	kW		6.80	9.50	12.1	13.4	9.50	12.1	13.4	
Heating capacity	Nom.	kW		7.50	10.8	13.5	15.5	10.8	13.5	15.5	
Space cooling	Energy efficiency class			A+	A+	-	-	A+	-	-	
	Capacity	Pdesign	kW	6.80	9.50	12.1	13.0	9.50	12.1	13.0	
	SEER			5.87	5.67	5.40	6.00	5.67	5.40	6.00	
	ηs,c			-	-	213	237	-	213	237	
Space heating (Average climate)	Annual energy consumption	kWh/a		405	586	1,345	1,300	586	1,345	1,300	
	Energy efficiency class			A+	A	-	-	A	-	-	
	Capacity	Pdesign	kW	4.50	6.00	7.80	7.80	6.00	7.80	7.80	
	SCOP/A			4.00	3.85	3.80	4.31	3.85	3.80	4.31	
	ηs,h			-	-	149	169	-	149	169	
Annual energy consumption	kWh/a		1,573	2,182	2,211	2,534	2,182	2,211	2,534		
<b>Indoor unit</b>				<b>FCAG</b>	<b>71B</b>	<b>100B</b>	<b>125B</b>	<b>140B</b>	<b>100B</b>	<b>125B</b>	<b>140B</b>
Dimensions	Unit	HeightxWidthxDepth	mm	204x840x840		246x840x840					
Weight	Unit			21		23					
Air filter	Type			Resin net							
Decoration panel	Model	Standard panels: BYCQ140E - white with grey louvers / BYCQ140EW - full white / BYCQ140EB - black Auto cleaning panels: BYCQ140EGF - white / BYCQ140EGFB - black Designer panels: BYCQ140EP - white / BYCQ140EPB - black									
	Dimensions	HeightxWidthxDepth	mm	Standard panels: 65x950x950 / Auto cleaning panels: 148x950x950 / Designer panels: 106x950x950							
Fan	Weight			Standard panels: 5.5 / Auto cleaning panels: 10.3 / Designer panels: 6.5							
	Air flow rate	Cooling	Low/Medium/High	m³/min	10.8/13.0/15.1	13.0/17.8/22.7	13.1/20.4/27.2	13.0/17.8/22.7	13.1/20.4/27.2	13.0/17.8/22.7	13.1/20.4/27.2
Sound power level	Heating	Low/Medium/High	m³/min	10.8/12.9/15.1	13.2/18.1/23.0	13.0/20.2/27.0	13.2/18.1/23.0	13.0/20.2/27.0	13.2/18.1/23.0	13.0/20.2/27.0	
	Cooling			dBA	51.0	54.0	58.0	54.0	58.0	58.0	
Sound pressure level	Heating			dBA	51.0	54.0	58.0	54.0	58.0	58.0	
	Cooling	Low/Medium/High	dBA	28.0/31.0/35.0	29.0/33.0/37.0	29.0/35.0/41.0	29.0/33.0/37.0	29.0/35.0/41.0	29.0/33.0/37.0	29.0/35.0/41.0	
Control systems	Heating	Low/Medium/High	dBA	28.0/31.0/33.0	29.0/33.0/37.0	29.0/35.0/41.0	29.0/33.0/37.0	29.0/35.0/41.0	29.0/33.0/37.0	29.0/35.0/41.0	
	Infrared remote control	BRC7FA532F / BRC7FB532F / BRC7FA532FB / BRC7FB532FB									
Wired remote control	BRC1H52W/S/K / BRC1E53A / BRC1E53B / BRC1E53C / BRC1D52										
Power supply	Phase/Frequency/Voltage	Hz/V		1~/50/60/220-240/220							
<b>Outdoor unit</b>				<b>ARXM71R</b>	<b>AZAS100MV1</b>	<b>AZAS125MV1</b>	<b>AZAS140MV1</b>	<b>AZAS100MY1</b>	<b>AZAS125MY1</b>	<b>AZAS140MY1</b>	
Dimensions	Unit	HeightxWidthxDepth	mm	734x954x401		990x940x320					
Weight	Unit			49.0		70	78	70	71	77	
Sound power level	Cooling			dBA	-	70	71	70	71	73	
	Heating			dBA	-	71	73	-	71	73	
Sound pressure level	Cooling	Nom.	dBA	52.0	53	54	53	53	54		
	Heating	Nom.	dBA	52.0	57						
Operation range	Cooling	Ambient	Min.~Max.	°CDB	---	-5 ~46					
	Heating	Ambient	Min.~Max.	°CWB	---	-15 ~15.5					
Refrigerant	Type/GWP	R-32/ 675.0									
Piping connections	Charge	kg/TCO2Eq	1.15 /0.780		2.60 /1.76		2.90 /1.96		2.60 /1.76		2.90 /1.96
	Liquid/Gas OD	mm	9.52/15.9								
Piping length	OU - IU	Max.	m	30							
	System	Equivalent	m	50							
Additional refrigerant charge	Chargeless	m	30								
	Level difference IU - OU	Max.	m	30.0							
Power supply	Phase/Frequency/Voltage	Hz/V		1~/50 /220-240		1~/50 /220-240		3~/50 /380-415			
Current - 50Hz	Maximum fuse amps (MFA)	A		-		25		32		16	

# Round flow cassette

360° air discharge for optimum efficiency and comfort

- › Combination with split outdoor units is ideal for small retail, offices or residential applications
- › Optional automatic filter cleaning panel results in higher efficiency & comfort and lower maintenance costs. 2 filters available: standard filter and finer mesh filter
- › Two optional intelligent sensors improve energy efficiency and comfort
- › Widest choice ever in decoration panels: designer panels in white (RAL9010) and black (RAL9005) and standard panels in white (RAL9010) with grey louvers or full white
- › Bigger flaps and unique swing pattern improve equal air distribution
- › Individual flap control: flexibility to suit every room layout without changing the location of the unit!
- › Optional fresh air intake
- › Branch duct discharge allows to optimize air distribution in irregular shaped rooms or to supply air to small adjacent rooms
- › Standard drain pump with 675mm lift increases flexibility and installation speed



More details and final information can be found by scanning or clicking the QR codes.



FCAG-B



RXM-R



RXM-R9

Efficiency data		FCAG + RXM		35B + 35R9		50B + 50R		60B + 60R		
Cooling capacity	Nom.	kW		3.50		5.00		5.70		
Heating capacity	Nom.	kW		4.20		6.00		7.00		
Space cooling	Energy efficiency class		A++		A++		A++			
	Capacity	Pdesign	kW		3.50		5.00		5.70	
	SEER			6.35		6.54		6.40		
	ηs,c			-		-		-		
Space heating (Average climate)	Annual energy consumption		kWh/a		193		268		312	
	Energy efficiency class		A++		A++		A+		A+	
	Capacity	Pdesign	kW		3.32		4.36		4.71	
	SCOP/A			4.90		4.30		4.20		
ηs,h			-		-		-		-	
Annual energy consumption		kWh/a		948		1,418		1,569		
Indoor unit		FCAG		50B		60B		35B		
Dimensions	Unit	HeightxWidthxDpeth		mm		204x840x840		18		
Weight	Unit			kg		19		18		
Air filter	Type					Resin net				
Decoration panel	Model					Standard panels: BYCQ140E - white with grey louvers / BYCQ140EW - full white / BYCQ140EB - black Auto cleaning panels: BYCQ140EGF - white / BYCQ140EGFB - black Designer panels: BYCQ140EP - white / BYCQ140EPB - black				
						Standard panels: 65x950x950 / Auto cleaning panels: 148x950x950 / Designer panels: 106x950x950				
						Standard panels: 5.5 / Auto cleaning panels: 10.3 / Designer panels: 6.5				
Fan	Air flow rate	Cooling	Low	9.4/11.8/14.6	9.6/12.2/14.9	8.8/10.6/12.9				
			High	11.8/14.6	14.9	14.1				
Sound power level	Cooling	Low/Medium/High		m³/min		m³/min				
		dBA		49.0		51.0		49.0		
Sound pressure level	Heating	Low/Medium/High		dBA		49.0				
		dBA		27.0/29.0/31.0		28.0/31.0/33.0		27.0/29.0/31.0		
Control systems	Infrared remote control	Low/Medium/High		dBA		27.0/29.0/31.0				
		dBA		27.0/29.0/31.0		28.0/31.0/33.0		27.0/29.0/31.0		
Power supply	Phase/Frequency/Voltage	Wired remote control		BRC7FA532F / BRC7FB532F / BRC7FA532FB / BRC7FB532FB						
		Wired remote control		BRC1H52W/S/K / BRC1E53A / BRC1E53B / BRC1E53C / BRC1D52						
						1~/50/60/220-240/220				
Outdoor unit		RXM		50R		60R		35R9		
Dimensions	Unit	HeightxWidthxDpeth		mm		734x870x373		552x840x350		
Weight	Unit			kg		49.0		32		
Sound power level	Cooling					-		49.0		
Sound pressure level	Cooling	Nom.		dBA		48.0		49.0		
		dBA		-		49.0		-		
Operation range	Cooling	Ambient	Min.~Max.	°CDB		-10 ~50 (4) / 46 (5)		-10 ~50 / 46		
		Ambient	Min.~Max.	°CWB		---		---		
Refrigerant	Type/GWP					R-32/675.0				
		Charge			kg/TCO2Eq		1.15 / 0.780		0.76 / 0.52	
Piping connections	Liquid/Gas OD		mm		6.35/12.7		6.35/9.50			
	Piping length	OU - IU	Max.	m		30		20		
	Additional refrigerant charge	System	Chargeless	m		-		10		
	Level difference	IU - OU	Max.	m		20.0		15		
Power supply	Phase/Frequency/Voltage		Hz/V		1~/50 / 220-240					
Current - 50Hz	Maximum fuse amps (MFA)		A		16		-			

Contains fluorinated greenhouse gases

# Fully Flat Cassette

Design & Genius in one



## Why choose fully flat cassette

- › Unique design in the market that integrates fully flat into the ceiling
- › Advanced technology and top efficiency combined
- › Most quiet cassette available on the market

## FFA-A9 / FXZQ-A



Choice between grey or white panel

## Benefits for the installer

- › Unique product in the market!
- › Most quiet unit (25dBA)
- › The user-friendly remote control, available in several languages, enables the easy set-up of sensor option and control of the individual flap position
- › Meeting European design taste.

## Benefits for the consultant

- › Unique product in the market!
- › Blends seamlessly in any modern office interior design
- › Ideal product to improve BREEAM score/EPBD in combination with Sky Air (FFA\*) or VRV IV heat pump units (FXZQ\*).

## Benefits for the end user

- › Engineering excellence and unique design in one
- › Most quiet unit (25dBA)
- › Perfect working conditions: no more cold draughts
- › Save up to 27% on your energy bill thanks to the optional sensors
- › Flexible usage of space and suits any room configuration thanks to individual flap control
- › User-friendly remote control, available in several languages.

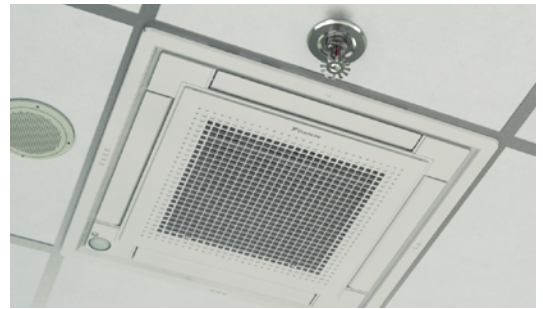
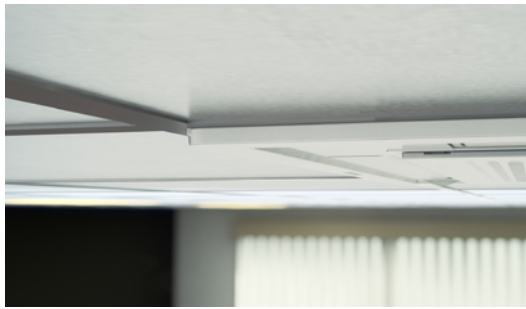

### Unique design

- › Designed by a European design office to fully meet the European taste.
- › Fully flat into the ceiling, leaving only 8mm.
- › Fully integrated in the one ceiling tile, enabling lights, speakers and sprinklers to be installed in adjoining ceiling tiles.
- › Decoration panel available in 2 colours (white and white-silver).



### Differentiating in technology

#### Optional presence sensor

- › When the room is empty, it can adjust the set temperature or switch off the unit – saving energy.
- › When people are detected, the direction of the airflow is adapted to avoid cold draughts being directed towards occupants.

#### Optional floor sensor

- › Detects the temperature difference and re-directs the airflow to ensure even temperature distribution.

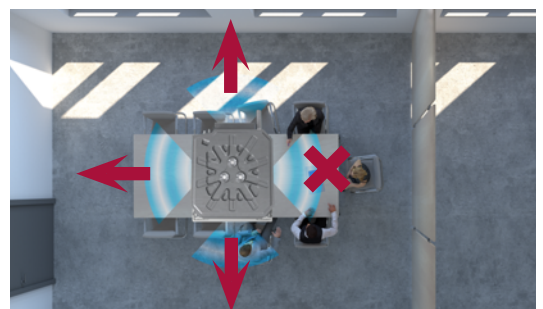

### Top efficiency

- › Seasonal efficiency labels up to **A++**\*
- › When the room is empty, the sensor option can adjust the set temperature or switch off the unit – saving up to 27% energy.

\* for FFA25,35A9 in combination with RXM25,35

### Other benefits

- › Individual flap control: easily control one or more flaps via the wired remote controller (BRC1E/ BRC1H) when rearranging the room. When fully closing or blocking the flaps, the option "Sealing member of air discharge outlet" is needed.
- › Most silent cassette in the market (25dBA), important for office applications.

## Marketing tools

- › [https://www.daikin.eu/en\\_us/product-group/fully-flat-cassette.html](https://www.daikin.eu/en_us/product-group/fully-flat-cassette.html)
- › [www.youtube.com/DaikinEurope](https://www.youtube.com/DaikinEurope)



# Fully flat cassette

Unique design in the market that integrates fully flat into the ceiling

- › Combination with Sky Air Alpha-series ensures best in class quality, highest efficiency and performance
- › Fully flat integration in standard architectural ceiling tiles, leaving only 8mm
- › Remarkable blend of iconic design and engineering excellence with an elegant finish in white or a combination of silver and white
- › Two optional intelligent sensors improve energy efficiency and comfort
- › Individual flap control: flexibility to suit every room layout without changing the location of the unit!
- › Optional fresh air intake
- › Branch duct discharge allows to optimize air distribution in irregular shaped rooms or to supply air to small adjacent rooms
- › Standard drain pump with 630mm lift increases flexibility and installation speed

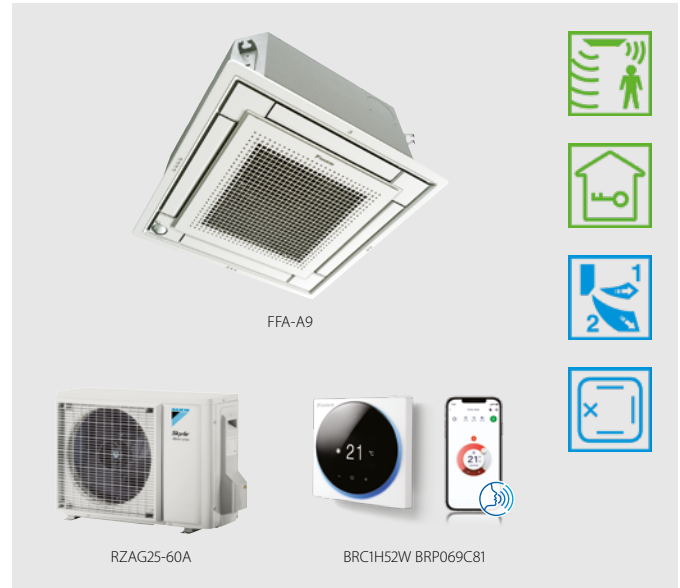

More details and final information can be found by scanning or clicking the QR codes.



FFA-A9



RZAG-A

Efficiency data		FFA + RZAG		35A9 + 35A		50A9 + 50A		60A9 + 60A		
Cooling capacity	Min./Nom./Max.	kW		1.6 /3.5 /4.5		1.7 /5.0 /6.0		1.7 /6.0 /6.5		
Heating capacity	Min./Nom./Max.	kW		1.40 /4.00 /5.00		1.50 /5.80 /6.00		1.60 /7.00 /7.50		
Space cooling	Energy efficiency class				A++		A+			
	Capacity	Pdesign	kW		3.50		5.00		6.00	
	SEER				6.40		6.30		5.80	
	Annual energy consumption		kWh/a		191		278		362	
Space heating (Average climate)	Energy efficiency class				A		A+			
	Capacity	Pdesign	kW		4.20		4.30		4.50	
	SCOP/A				3.80		4.01		4.04	
	Annual energy consumption		kWh/a		1,546		1,501		1,558	
Indoor unit		FFA		35A9		50A9		60A9		
Dimensions	Unit	HeightxWidthxDepth		mm		260 x575 x575				
Weight	Unit	kg		16.0		17.5				
Air filter	Type					Resin net				
Decoration panel	Model					BYFQ60C2W1W / BYFQ60C2W1S / BYFQ60B2W1 / BYFQ60B3W1				
	Colour					White (N9.5)/SILVER/White (RAL9010)/WHITE (RAL9010)				
	Dimensions	HeightxWidthxDepth	mm		46 x620 x620 x46 x620 x620 x55 x700 x700 x55 x700 x700					
	Weight	kg		2.8 /2.8 /2.7 /2.7						
Fan	Air flow rate	Cooling	Low/Medium/High	m <sup>3</sup> /min	6.5 /8.5 /10.0		8.6 /10.9 /12.7		9.5 /12.5 /14.5	
		Heating	Low/Medium/High	m <sup>3</sup> /min	6.5 /8.5 /10.0		8.6 /10.9 /12.7		9.5 /12.5 /14.5	
Sound power level	Cooling	dBA		51.0		56.0		60.0		
Sound pressure level	Cooling	Low/Medium/High	dBA		25.0 /30.5 /34.0		27.0 /34.0 /39.0		32.0 /40.0 /43.0	
	Heating	Low/Medium/High	dBA		25.0 /30.5 /34.0		27.0 /34.0 /39.0		32.0 /40.0 /43.0	
Control systems	Infrared remote control				BRC7EB530W (standard panel) / BRC7F530W (white panel) / BRC7F530S (grey panel)					
	Wired remote control				BRC1H52W/S/K / BRC1E53A / BRC1E53B / BRC1E53C / BRC1D52					
Power supply	Phase/Frequency/Voltage		Hz/V		1~/50 /220-240					
Outdoor unit		RZAG		35A		50A		60A		
Dimensions	Unit	HeightxWidthxDepth		mm		734 x870 x373				
Weight	Unit	kg		52						
Sound power level	Cooling	dBA		62.0		63.0		64.0		
	Heating	dBA		62.0		63.0		64.0		
Sound pressure level	Cooling	Nom.	dBA		48.0		49.0		50.0	
	Heating	Nom.	dBA		48.0		49.0		50.0	
Operation range	Cooling	Ambient	Min.~Max.	°CDB	-20~-52					
	Heating	Ambient	Min.~Max.	°CWB	-20~-24					
Refrigerant	Type/GWP				R-32/675.0					
	Charge		kg/TCO2Eq		1.55 /1.05					
Piping connections	Liquid/Gas OD		mm		6.35 /9.50		6.35 /12.7			
	Piping length	OU - IU	Max.	m	50					
	System Chargeless		m		30					
	Additional refrigerant charge		kg/m		0.02 (for piping length exceeding 30m)					
	Level difference	IU - OU	Max.	m	30.0					
Power supply	Phase/Frequency/Voltage		Hz/V		1~/50 /220-240					

Contains fluorinated greenhouse gases

# Fully flat cassette

Unique design in the market that integrates fully flat into the ceiling

- > Combination with split outdoor units is ideal for small retail, offices and residential applications
- > Fully flat integration in standard architectural ceiling tiles, leaving only 8mm
- > Remarkable blend of iconic design and engineering excellence with an elegant finish in white or a combination of silver and white
- > Unified indoor unit range for R-32 and R-410A
- > Two optional intelligent sensors improve energy efficiency and comfort
- > Individual flap control: flexibility to suit every room layout without changing the location of the unit!
- > Optional fresh air intake
- > Branch duct discharge allows to optimize air distribution in irregular shaped rooms or to supply air to small adjacent rooms
- > Standard drain pump with 630mm lift increases flexibility and installation speed



More details and final information can be found by scanning or clicking the QR codes.



FFA-A9



RXM-R



RXM-R9

Efficiency data		FFA + RXM	25A9 + 25R9	35A9 + 35R9	50A9 + 50R	60A9 + 60R		
Cooling capacity	Nom.	kW	2.50	3.40	5.00	5.70		
Heating capacity	Nom.	kW	3.20	4.20	5.80	7.00		
Space cooling	Energy efficiency class		A++		A+			
	Capacity	Pdesign	kW	2.50	3.40	5.00	5.70	
	SEER		6.17	6.38	5.98	5.76		
	Annual energy consumption	kWh/a	142	186	293	346		
Space heating (Average climate)	Energy efficiency class		A+		A			
	Capacity	Pdesign	kW	2.31	3.10	3.84	3.96	
	SCOP/A		4.24	4.10	3.90	4.04		
	Annual energy consumption	kWh/a	762	1,058	1,378	1,373		
Indoor unit		FFA	25A9	35A9	50A9	60A9		
Dimensions	Unit	HeightxWidthxDpeth	mm					
			260x575x575					
Weight	Unit		16.0		17.5			
Air filter	Type		Resin net					
Decoration panel	Model		BYFQ60C2W1W / BYFQ60C2W1S / BYFQ60B2W1 / BYFQ60B3W1					
	Colour		White (N9.5)/SILVER/White (RAL9010)/WHITE (RAL9010)					
	Dimensions	HeightxWidthxDpeth	mm					
			46 x620 x620 x46 x620 x620 x55 x700 x700 x55 x700 x700					
	Weight	kg	2.8/2.8/2.7/2.7					
Fan	Air flow rate	Cooling	Low/Medium/High	m <sup>3</sup> /min	6.5/8.0/9.0	6.5/8.5/10.0	8.6/10.9/12.7	9.5/12.5/14.5
		Heating	Low/Medium/High	m <sup>3</sup> /min	6.5/8.0/9.0	6.5/8.5/10.0	8.6/10.9/12.7	9.5/12.5/14.5
Sound power level	Cooling		dBA	48.0	51.0	56.0	60.0	
Sound pressure level	Cooling	Low/Medium/High	dBA	25.0/28.5/31.0	25.0/30.5/34.0	27.0/34.0/39.0	32.0/40.0/43.0	
	Heating	Low/Medium/High	dBA	25.0/28.5/31.0	25.0/30.5/34.0	27.0/34.0/39.0	32.0/40.0/43.0	
Control systems	Infrared remote control	BRC7EB530W (standard panel) / BRC7F530W (white panel) / BRC7F530S (grey panel)						
	Wired remote control	BRC1H52W/S/K / BRC1E53A / BRC1E53B / BRC1E53C / BRC1D52						
Power supply	Phase/Frequency/Voltage	Hz/V	1~/50 /220-240					
Outdoor unit		RXM	25R9	35R9	50R	60R		
Dimensions	Unit	HeightxWidthxDpeth	552x840x350		734x870x373			
Weight	Unit	kg	32		49.0			
Sound pressure level	Cooling	Nom.	dBA	46.0	49.0	48.0		
	Heating	Nom.	dBA	47.0		49.0		
Operation range	Cooling	Ambient	Min.~Max.	-10~50/46		-10~50/46		
Refrigerant	Type	R-32						
	GWP			675	675.0			
	Charge	kg/TCO2Eq	0.76 /0.52		1.15 /0.780			
Piping connections	Liquid	OD	mm					
			6.35					
	Gas	OD	mm					
			9.50					
	Piping length	OU - IU	Max.	m				
		System	Chargeless	m				
			10					
	Additional refrigerant charge	kg/m	0.02 (for piping length exceeding 10m)					
	Level difference IU - OU	Max.	m					
			15					
Power supply	Phase/Frequency/Voltage	Hz/V	1~/50 /220-240					
Current - 50Hz	Maximum fuse amps (MFA)	A	-		16			

Contains fluorinated greenhouse gases

# Auto cleaning filter

## for concealed ceiling units

The unique automatic cleaning filter achieves higher efficiency and comfort with lower maintenance costs

### Reduce running costs

- › Automatic filter cleaning ensures low maintenance costs because the filter is always clean

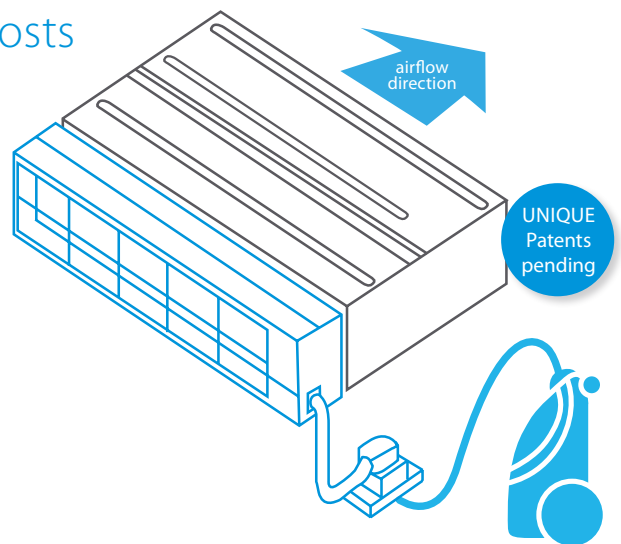
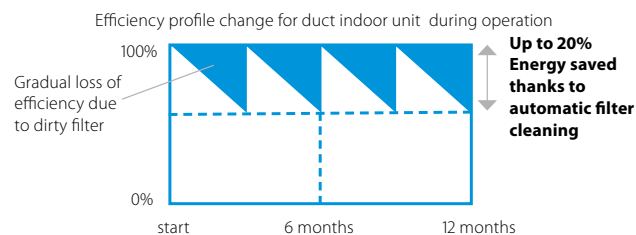

### Minimal time required for filter cleaning

- › The dust box can be emptied with a vacuum cleaner for fast and easy cleaning
- › No more dirty ceilings

### Improved indoor air quality

- › Optimum airflow eliminates draft and insulates sound

### Superb reliability

- › Prevents clogged filters for seamless operation

### Unique technology

- › Unique and innovative filter technology inspired by the Daikin auto cleaning cassette



## How does it work?

- 1 Scheduled automatic filter cleaning
- 2 Dust collects in a dust box that's integrated into the unit
- 3 The dust can easily be removed with a vacuum cleaner

### Combination table

	Split / Sky Air				VRV						
	FDXM-F9				FXDA-A/FXDQ-A3						
	25	35	50	60	15	20	25	32	40	50	63
BAE20A62	•	•			•	•	•	•			
BAE20A82									•	•	
BAE20A102			•	•							•



youtube.com/DaikinEurope



### Specifications

	BAE20A62	BAE20A82	BAE20A102
Height (mm)	210		
Width (mm)	830	1,030	1,230
Depth (mm)	188		





# Slim concealed ceiling unit

Compact concealed ceiling unit, with a height of only 200mm

- › Combination with Sky Air Alpha-series ensures best in class quality, highest efficiency and performance
- › Invisible unit as the unit is concealed in the ceiling: only the suction and discharge grilles are visible
- › Compact dimensions, can easily be mounted in a ceiling void of only 240mm
- › Medium external static pressure up to 40Pa facilitates unit use with flexible ducts of varying lengths
- › Auto cleaning filter option ensures maximum efficiency, comfort and reliability by regular filter cleaning
- › Multi zoning kit allows multiple individually-controlled climate zones to be served by one indoor unit
- › Onecta app (optional): control your indoor from any location with an app, via your local network or internet and keep an overview on your energy consumption

with auto cleaning and multi zoning option



More details and final information can be found by scanning or clicking the QR codes.



FDXM-F9



RZAG-A

Efficiency data		FDXM + RZAG		35F9 + 35A		50F9 + 50A		60F9 + 60A	
Cooling capacity	Min./Nom./Max.	kW		1.6 /3.5 /4.5		1.7 /5.0 /6.0		1.7 /6.0 /6.5	
Heating capacity	Min./Nom./Max.	kW		1.40 /4.00 /5.00		1.70 /5.00 /6.00		1.70 /7.00 /7.50	
Space cooling	Energy efficiency class					A+			
	Capacity	Pdesign	kW	3.50		5.00		6.00	
	SEER			5.90				5.70	
	Annual energy consumption			kWh/a		208		296	
Space heating (Average climate)	Energy efficiency class					A			
	Capacity	Pdesign	kW	3.50		4.30		4.50	
	SCOP/A					3.90			
	Annual energy consumption			kWh/a		1,255		1,544	
Annual energy consumption		kWh/a		1,616					
Indoor unit		FDXM		35F9		50F9		60F9	
Dimensions	Unit	HeightxWidthxD	Depth	mm		200 x750 x620		200 x1,150 x620	
Weight	Unit			kg		21		28	
Air filter	Type					Removable / washable			
Fan	Air flow rate	Cooling	Low/Medium/High	m <sup>3</sup> /min		7.3/8.0/8.7		13.3/14.6/15.8	
		Heating	Low/Medium/High	m <sup>3</sup> /min		7.3/8.0/8.7		13.3/14.6/15.8	
	External static pressure	Nom.	Pa		30		40		
Sound power level	Cooling			dBA		53.0		55.0	
	Heating			dBA		53.0		55.0	
Sound pressure level	Cooling	Low/High	dBA		27.0 /35.0		30.0 /38.0		
	Heating	Low/High	dBA		27.0 /35.0		30.0 /38.0		
Control systems	Infrared remote control					BRC4C65			
	Wired remote control					BRC1H52W/S/K, BRC1E53A/B/C, BRC1D52			
Outdoor unit		RZAG		35A		50A		60A	
Dimensions	Unit	HeightxWidthxD	Depth	mm		734 x870 x373			
Weight	Unit			kg		52			
Sound power level	Cooling			dBA		62.0		63.0	
	Heating			dBA		62.0		63.0	
Sound pressure level	Cooling	Nom.	dBA		48.0		49.0		
	Heating	Nom.	dBA		48.0		49.0		
Operation range	Cooling	Ambient	Min.~Max.	°CDB		-20~-52			
	Heating	Ambient	Min.~Max.	°CWB		-20~-24			
Refrigerant	Type/GWP					R-32/675.0			
	Charge			kg/TCO <sub>2</sub> Eq		1.55 /1.05			
Piping connections	Liquid/Gas OD			mm		6.35/9.50		6.35/12.7	
	Piping length	OU - IU	Max.	m		50			
	System Chargeless			m		30			
	Additional refrigerant charge			kg/m		0.02 (for piping length exceeding 30m)			
Power supply	Level difference IU - OU			Max.		m		30.0	
	Phase/Frequency/Voltage			Hz/V		1~/50 /220-240			

Contains fluorinated greenhouse gases

# Slim concealed ceiling unit

Compact concealed ceiling unit, with a height of only 200mm

- › Combination with split outdoor units is ideal for small retail, offices and residential applications
- › Invisible unit as the unit is concealed in the ceiling: only the suction and discharge grilles are visible
- › Compact dimensions, can easily be mounted in a ceiling void of only 240mm
- › Medium external static pressure up to 40Pa facilitates unit use with flexible ducts of varying lengths
- › Auto cleaning filter option ensures maximum efficiency, comfort and reliability by regular filter cleaning
- › Multi zoning kit allows multiple individually-controlled climate zones to be served by one indoor unit
- › Onecta app (optional): control your indoor from any location with an app, via your local network or internet and keep an overview on your energy consumption

**with auto cleaning and multi zoning option**



More details and final information can be found by scanning or clicking the QR codes.



FDXM-F9



RXM-R



RXM-R9

Efficiency data		FDXM + RXM		25F9 + 25R9	35F9 + 35R9	50F9 + 50R	60F9 + 60R	
Cooling capacity	Min./Nom./Max.	kW		1.30/2.40/3.00	1.40/3.40/3.80	1.70/5.00/5.30	1.70/6.00/6.50	
Heating capacity	Min./Nom./Max.	kW		1.30/3.20/4.50	1.40/4.00/5.00	1.70/5.80/6.00	1.70/7.00/7.10	
Space cooling	Energy efficiency class			A+	A	A+	A	
	Capacity	Pdesign	kW	2.40	3.40	5.00	6.00	
	SEER			5.68	5.26	5.77	5.56	
	Annual energy consumption		kWh/a	148	226	303	378	
Space heating (Average climate)	Energy efficiency class			A+		A		
	Capacity	Pdesign	kW	2.60	2.90	4.00	4.60	
	SCOP/A			4.24	3.88	3.93	3.80	
	Annual energy consumption		kWh/a	858	1,046	1,424	1,693	
Indoor unit		FDXM		25F9	35F9	50F9	60F9	
Dimensions	Unit	HeightxWidthxDepth		mm		200x750x620		
Weight	Unit	kg		21		28		
Air filter	Type	Removable / washable						
Fan	Air flow rate	Cooling	Low/Medium/High	m <sup>3</sup> /min		7.3/8.0/8.7		
		Heating	Low/Medium/High	m <sup>3</sup> /min		7.3/8.0/8.7		
	External static pressure	Nom.	Pa	30		40		
Sound power level	Cooling	dBA		53.0		55.0		
	Heating	dBA		53.0		55.0		
Sound pressure level	Cooling	Low/High	dBA		27.0/35.0		30.0/38.0	
	Heating	Low/High	dBA		27.0/35.0		30.0/38.0	
Control systems	Infrared remote control		BRC4C65					
	Wired remote control		BRC1H52W/S/K, BRC1E53A/B/C, BRC1D5					
Outdoor unit		RXM		25R9	35R9	50R	60R	
Dimensions	Unit	HeightxWidthxDepth		mm		552x840x350		
Weight	Unit	kg		32		49.0		
Sound pressure level	Cooling	Nom.	dBA		46.0		49.0	
	Heating	Nom.	dBA		47.0		49.0	
Operation range	Cooling	Ambient	Min.~Max.	°CDB		-10~50/46		
Refrigerant	Type/GWP		R-32/675.0					
	Charge		kg/TCO2Eq	0.76/0.52		1.15/0.780		
Piping connections	Liquid/Gas OD		mm		6.35/9.50		6.35/12.7	
	Piping length	OU - IU	Max.	m		20		
		System	Chargeless	m		10		
	Additional refrigerant charge		kg/m		0.02 (for piping length exceeding 10m)			
Level difference	IU - OU	Max.		m		15		
Power supply	Phase/Frequency/Voltage		Hz/V		1~/50 /220-240			
Current - 50Hz	Maximum fuse amps (MFA)		A		-			
						16		

Contains fluorinated greenhouse gases

# Concealed ceiling unit with medium ESP

Slimmest yet most powerful medium static pressure unit on the market

- › Slimmest unit in class, only 245mm (300mm built-in height) and therefore narrow ceiling voids are no longer a challenge
- › Low operation sound level down to 25dBA
- › Medium external static pressure up to 150Pa facilitates using flexible ducts of varying lengths
- › Possibility to change ESP via wired remote control allows optimisation of the supply air volume
- › Discretely concealed in the ceiling: only the suction and discharge grilles are visible
- › Multi zoning kit allows multiple individually-controlled climate zones to be served by one indoor unit
- › Optional fresh air intake
- › Flexible installation: air suction direction can be altered from rear to bottom suction and choice between free use or connection to optional suction grilles
- › Standard built-in drain pump with 625mm lift increases flexibility and installation speed

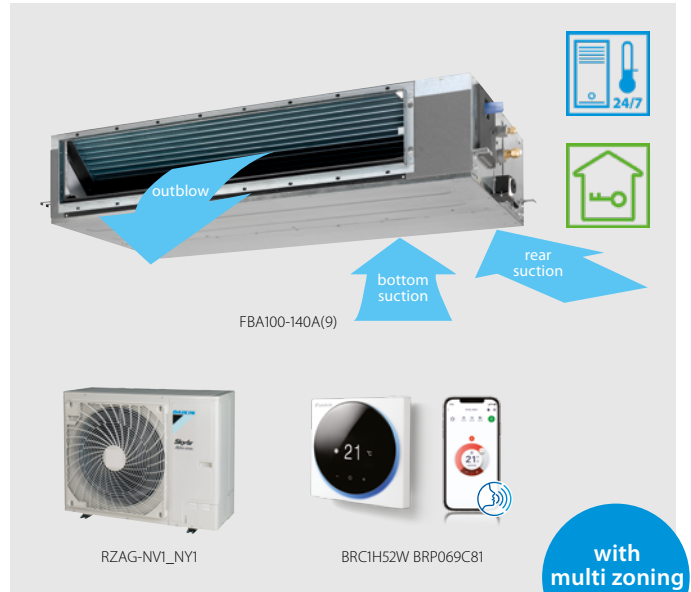

More details and final information can be found by scanning or clicking the QR codes.



Efficiency data			FBA + RZAG															
			35A9 + 35A	50A9 + 50A	60A9 + 60A	71A9 + 71NV1	100A + 100NV1	125A + 125NV1	140A + 140NV1	71A9 + 71NY1	100A + 100NY1	125A + 125NY1	140A + 140NY1					
Cooling capacity	Min./Nom./Max.	kW	1.6 / 3.5 / 5.0	1.7 / 5.0 / 6.0	1.7 / 6.0 / 7.0	- / 6.80 / -	- / 9.50 / -	- / 12.1 / -	- / 13.4 / -	- / 6.80 / -	- / 9.50 / -	- / 12.1 / -	- / 13.4 / -					
Heating capacity	Min./Nom./Max.	kW	1.40 / 4.00 / 5.00	1.70 / 6.00 / 6.00	1.70 / 7.00 / 7.50	- / 7.50 / -	- / 10.8 / -	- / 13.5 / -	- / 15.5 / -	- / 7.50 / -	- / 10.8 / -	- / 13.5 / -	- / 15.5 / -					
Space cooling	Energy efficiency class		A++				-				A++							
	Capacity	Pdesign kW	3.50	5.00	6.00	6.80	9.50	12.1	13.4	6.80	9.50	12.1	13.4					
	SEER		6.12	6.30	6.15	6.50	6.47	6.56	6.42	6.50	6.47	6.56	6.42					
	ηs,c	%	-				259				254							
Annual energy consumption	kWh/a	200	278	341	366	514	1,107	1,252	366	514	1,107	1,252						
Space heating (Average climate)	Energy efficiency class		A+				-				A+							
	Capacity	Pdesign kW	4.20	4.30	4.50	4.70	7.80	9.52		4.70	7.80	9.52						
	SCOP/A		4.10		4.20	4.36	4.37	4.34	4.20	4.36	4.37	4.34						
	ηs,h	%	-				172				171							
Annual energy consumption	kWh/a	1,434	1,469	1,537	1,566	2,505	3,050	3,070	1,566	2,505	3,050	3,070						
Indoor unit			FBA	35A9	50A9	60A9	71A9	100A	125A	140A	71A9	100A	125A	140A				
Dimensions	Unit	HeightxWidthxDepth	mm	245x700x800			245x1,000x800		245x1,400x800			245x1,000x800			245x1,400x800			
Weight	Unit		kg	28.0			35.0		46.0			35.0			46.0			
Air filter	Type		Resin net															
Fan	Air flow rate	Cooling Low/Medium/High	m³/min	10.5/12.5/15.0			12.5/15.0/18.0		23.0/26.0/29.0		23.5/29.0/34.0		12.5/15.0/18.0		23.0/26.0/29.0		23.5/29.0/34.0	
		Heating Low/Medium/High	m³/min	10.5/12.5/15.0			12.5/15.0/18.0		23.0/26.0/29.0		23.5/29.0/34.0		12.5/15.0/18.0		23.0/26.0/29.0		23.5/29.0/34.0	
		External static pressure	Nom./High Pa	30 / 150			40 / 150		50 / 150		30 / 150		40 / 150		50 / 150			
Sound power level	Cooling		dBA	60.0			56.0		58.0		62.0		56.0		58.0		62.0	
Sound pressure level	Cooling	Low/Medium/High	dBA	29.0/32.0/35.0			25.0/28.0/30.0		30.0/32.0/34.0		32.0/35.0/37.0		25.0/28.0/30.0		30.0/32.0/34.0		32.0/35.0/37.0	
	Heating	Low/Medium/High	dBA	29.0/34.0/37.0			25.0/28.0/31.0		30.0/33.0/36.0		32.0/35.0/38.0		25.0/28.0/31.0		30.0/33.0/36.0		32.0/35.0/38.0	
Control systems	Infrared remote control		BRC4C65 / BRC4C66															
	Wired remote control		BRC1H52W/S/K / BRC1E53A / BRC1E53B / BRC1E53C / BRC1D52															
Power supply	Phase/Frequency/Voltage		Hz/V 1~/50/60/220-240/220															
Outdoor unit			RZAG	35A	50A	60A	71NV1	100NV1	125NV1	140NV1	71NY1	100NY1	125NY1	140NY1				
Dimensions	Unit	HeightxWidthxDepth	mm	734 x 870 x 373			870 x 1,100 x 460											
Weight	Unit		kg	52			81	85	95		81	85	94					
Sound power level	Cooling		dBA	62.0	63.0	64.0	64	66	69	70	64	66	69	70				
	Heating		dBA	62.0	63.0	64.0	-	-	68	71	-	-	68	71				
Sound pressure level	Cooling	Nom.	dBA	48.0	49.0	50.0	46	47	49	50	46	47	49	50				
	Heating	Nom.	dBA	48.0	49.0	50.0	48	50	52		48	50	52					
Operation range	Cooling	Ambient	Min.~Max. °CDB	-20~-52			-20~-52											
	Heating	Ambient	Min.~Max. °CWB	-20~-24			-20~-18											
Refrigerant	Type/GWP		R-32/675.0															
	Charge	kg/TCO2Eq	1.55/1.05			3.20/2.16		3.70/2.50		3.20/2.16		3.70/2.50						
Piping connections	Liquid/Gas	OD	mm	6.35/9.50		6.35/12.7		9.52/15.9										
	Piping length	OU - IU	Max. m	50			55	85		55	85							
		System	Equivalent Chargeless	-			75	100		75	100							
				30			40											
		Additional refrigerant charge	kg/m	0.02 (for piping length exceeding 30m)						See installation manual								
	Level difference	IU - OU	Max. m	30.0														
Power supply	Phase/Frequency/Voltage		Hz/V 1~/50 / 220-240															
Current - 50Hz	Maximum fuse amps (MFA)		-			20	32		16									

Contains fluorinated greenhouse gases

# Concealed ceiling unit with medium ESP

Slimmest yet most powerful medium static pressure unit on the market

- > Combination with Sky Air Advance-series ensures good value for money for all types of commercial applications
- > Slimmest unit in class, only 245mm (300mm built-in height) and therefore narrow ceiling voids are no longer a challenge
- > Low operation sound level down to 25dBA
- > Medium external static pressure up to 150Pa facilitates using flexible ducts of varying lengths
- > Possibility to change ESP via wired remote control allows optimisation of the supply air volume



## Optimised supply air volume

Automatically selects the most appropriate fan curve to achieve the units' nominal air flow within ±10%

### Why?

After installation the real ducting will frequently differ from the initially calculated air flow resistance → the real air flow may be much lower or higher than nominal, leading to a lack of capacity or uncomfortable air temperature. Automatic Airflow Adjustment function will adapt the unit's fan speed to any ducting automatically (10 or more fan curves are available on every model), making installation much faster

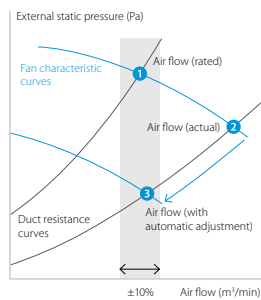

More details and final information can be found by scanning or clicking the QR codes.



FBA-A(9)



RZASG-MV1



RZASG-MY1



Efficiency data		FBA + RZASG		71A9 + 71MV1	100A + 100MV1	125A + 125MV1	140A + 140MV1	100A + 100MY1	125A + 125MY1	140A + 140MY1
Cooling capacity	Nom.	kW		6.80	9.50	12.1	13.4	9.50	12.1	13.4
Heating capacity	Nom.	kW		7.50	10.8	13.5	15.5	10.8	13.5	15.5
Space cooling	Energy efficiency class			A++	A+	-	-	A+	-	-
	Capacity	Pdesign	kW	6.80	9.50	12.1	13.4	9.50	12.1	13.4
	SEER			6.19	5.83	5.49	5.81	5.83	5.49	5.81
	ηs,c		%	-	-	217	229	-	217	229
	Annual energy consumption	kWh/a		385	570	1,322	1,384	570	1,322	1,384
Space heating (Average climate)	Energy efficiency class			A+	A	-	-	A	-	-
	Capacity	Pdesign	kW	4.50	6.00	-	7.80	6.00	-	7.80
	SCOP/A			4.01	3.85	3.63	3.85	-	3.63	3.85
	ηs,h		%	-	-	142	151	-	142	151
	Annual energy consumption	kWh/a		1,571	2,182	2,314	2,836	2,182	2,314	2,836
<b>Indoor unit</b>		<b>FBA</b>		<b>71A9</b>	<b>100A</b>	<b>125A</b>	<b>140A</b>	<b>100A</b>	<b>125A</b>	<b>140A</b>
Dimensions	Unit	HeightxWidthxDpeth		mm	245 x1,000 x800	245 x1,400 x800				
Weight	Unit	kg		35.0	46.0					
Air filter	Type	Resin net								
Fan	Air flow rate	Cooling	Low/Medium/High	m³/min	12.5 /15.0 /18.0	23.0 /26.0 /29.0	23.5 /29.0 /34.0	23.0 /26.0 /29.0	23.5 /29.0 /34.0	23.5 /29.0 /34.0
	Heating	Low/Medium/High	m³/min	12.5 /15.0 /18.0	23.0 /26.0 /29.0	23.5 /29.0 /34.0	23.0 /26.0 /29.0	23.5 /29.0 /34.0	23.5 /29.0 /34.0	
	External static pressure	Nom./High	Pa	30 /150	40 /150	50 /150	40 /150	50 /150		
Sound power level	Cooling	dBA		56.0	58.0	62.0	58.0	62.0		
Sound pressure level	Cooling	Low/Medium/High	dBA	25.0 /28.0 /30.0	30.0 /32.0 /34.0	32.0 /35.0 /37.0	30.0 /32.0 /34.0	32.0 /35.0 /37.0		
	Heating	Low/Medium/High	dBA	25.0 /28.0 /31.0	30.0 /33.0 /36.0	32.0 /35.0 /38.0	30.0 /33.0 /36.0	32.0 /35.0 /38.0		
Control systems	Infrared remote control		BRC4C65 / BRC4C66							
	Wired remote control		BRC1H52W/S/K / BRC1E53A / BRC1E53B / BRC1E53C / BRC1D52							
Power supply	Phase/Frequency/Voltage		Hz/V		1~/50/60/220-240/220					
<b>Outdoor unit</b>		<b>RZASG</b>		<b>71MV1</b>	<b>100MV1</b>	<b>125MV1</b>	<b>140MV1</b>	<b>100MY1</b>	<b>125MY1</b>	<b>140MY1</b>
Dimensions	Unit	HeightxWidthxDpeth		mm	770 x900 x320	990 x940 x320				
Weight	Unit	kg		60	70	78	70	77		
Sound power level	Cooling	dBA		65	70	71	73	70	71	73
	Heating	dBA		-	71	73	-	71	73	
Sound pressure level	Cooling	Nom.	dBA	46	53	54	53	54		
	Heating	Nom.	dBA	47	57					
Operation range	Cooling	Ambient	Min.~Max.	°CDB	-15 ~46					
	Heating	Ambient	Min.~Max.	°CWB	-15 ~15.5					
Refrigerant	Type/GWP		R-32/675							
	Charge	kg/TCO2Eq		2.45 /1.65	2.60 /1.76	2.90 /1.96	2.60 /1.76	2.90 /1.96		
Piping connections	Liquid/Gas OD		mm		9.52 /15.9					
	Piping length	OU - IU	Max.	m	50					
	System	Equivalent	m	70						
	Chargeless	m	30							
	Additional refrigerant charge	kg/m		See installation manual						
	Level difference	IU - OU	Max.	m	30.0					
Power supply	Phase/Frequency/Voltage		Hz/V		1~/50 /220-240				3~/50 /380-415	
Current - 50Hz	Maximum fuse amps (MFA)		A		20	25	32	16		

Contains fluorinated greenhouse gases

# Concealed ceiling unit with medium ESP

Slimmest yet most powerful medium static pressure unit on the market

- > Ideal solution for small businesses and shops
- > Slimmest unit in class, only 245mm (300mm built-in height) and therefore narrow ceiling voids are no longer a challenge
- > Low operation sound level down to 25dBA
- > Medium external static pressure up to 150Pa facilitates using flexible ducts of varying lengths
- > Possibility to change ESP via wired remote control allows optimisation of the supply air volume
- > Discretely concealed in the ceiling: only the suction and discharge grilles are visible
- > Multi zoning kit allows multiple individually-controlled climate zones to be served by one indoor unit
- > Reduced energy consumption thanks to specially developed DC fan motor
- > Optional fresh air intake
- > Flexible installation: air suction direction can be altered from rear to bottom suction and choice between free use or connection to optional suction grilles
- > Standard built-in drain pump with 625mm lift increases flexibility and installation speed



with multi zoning option

More details and final information can be found by scanning or clicking the QR codes.



FBA-A(9)



ARXM-R



AZAS-MV1



AZAS-MY1

Efficiency data		FCAG + ARXM / AZAS		71A9 + ARXM71R	100A + AZAS100MV1	125A + AZAS125MV1	140A + AZAS140MV1	100A + AZAS100MY1	125A + AZAS125MY1	140A + AZAS140MY1
Cooling capacity	Nom.	kW		6.80	9.50	12.1	13.4	9.50	12.1	13.4
Heating capacity	Nom.	kW		7.50	10.8	13.5	15.5	10.8	13.5	15.5
Space cooling	Energy efficiency class			A	A	-	-	A	-	-
	Capacity	Pdesign	kW	6.80	9.50	12.1	13.0	9.50	12.1	13.0
	SEER			5.57	5.25	4.85	5.50	5.25	4.85	5.50
	ηs,c			-	-	191	217	-	191	217
	Annual energy consumption		kWh/a	427	633	1,497	1,418	633	1,497	1,418
Space heating (Average climate)	Energy efficiency class			A	-	-	-	A	-	-
	Capacity	Pdesign	kW	4.50	6.00	7.80	7.80	6.00	7.80	7.80
	SCOP/A			3.81	3.55	3.85	3.81	3.55	3.85	3.85
	ηs,h			-	139	151	-	139	151	151
	Annual energy consumption		kWh/a	1,652	2,205	2,366	2,836	2,205	2,366	2,836
<b>Indoor unit</b>		<b>FBA</b>		<b>71A9</b>	<b>100A</b>	<b>125A</b>	<b>140A</b>	<b>100A</b>	<b>125A</b>	<b>140A</b>
Dimensions	Unit	HeightxWidthxDepth	mm	245 x1,000 x800	245 x1,400 x800					
Weight	Unit		kg	35.0	46.0					
Air filter	Type			Resin net						
Fan	Air flow rate	Cooling	Low/Medium/High	m³/min	12.5 /15.0 /18.0	23.0 /26.0 /29.0	23.5 /29.0 /34.0	23.0 /26.0 /29.0	23.5 /29.0 /34.0	23.5 /29.0 /34.0
		Heating	Low/Medium/High	m³/min	12.5 /15.0 /18.0	23.0 /26.0 /29.0	23.5 /29.0 /34.0	23.0 /26.0 /29.0	23.5 /29.0 /34.0	23.5 /29.0 /34.0
	External static pressure	Nom./High	Pa	30 /150	40 /150	50 /150	40 /150	50 /150		
Sound power level	Cooling		dBA	56.0	58.0	62.0	58.0	62.0		
Sound pressure level	Cooling	Low/Medium/High	dBA	25.0 /28.0 /30.0	30.0 /32.0 /34.0	32.0 /35.0 /37.0	30.0 /32.0 /34.0	32.0 /35.0 /37.0		
	Heating	Low/Medium/High	dBA	25.0 /28.0 /31.0	30.0 /33.0 /36.0	32.0 /35.0 /38.0	30.0 /33.0 /36.0	32.0 /35.0 /38.0		
Control systems	Infrared remote control			BRC4C65 / BRC4C66						
	Wired remote control			BRC1H52W/S/K / BRC1E53A / BRC1E53B / BRC1E53C / BRC1D52						
Power supply	Phase/Frequency/Voltage		Hz/V	1~/50/60/220-240/220						
<b>Outdoor unit</b>		<b>ARXM71R</b>		<b>AZAS100MV1</b>	<b>AZAS125MV1</b>	<b>AZAS140MV1</b>	<b>AZAS100MY1</b>	<b>AZAS125MY1</b>	<b>AZAS140MY1</b>	
Dimensions	Unit	HeightxWidthxDepth	mm	734 x954 x401	990 x940 x320					
Weight	Unit		kg	49.0	70	78	70	77		
Sound power level	Cooling	Nom.	dBA	-	70	71	70	71		
		Max.	dBA	-	71	73	71	73		
Sound pressure level	Cooling	Nom.	dBA	52.0	53	54	53	54		
	Heating	Nom.	dBA	52.0	57	57	57	57		
Operation range	Cooling	Ambient	Min.~Max.	°CDB	-10~46	-5~46	-5~46	-5~46		
	Heating	Ambient	Min.~Max.	°CWB	-15~18	-15~15.5	-15~15.5	-15~15.5		
Refrigerant	Type/GWP			R-32/675						
Piping connections	Charge		kg/TCO2Eq	1.15 /0.780	2.60 /1.76	2.90 /1.96	2.60 /1.76	2.90 /1.96		
	Liquid/Gas OD		mm	9.52 /15.9						
Piping length	OU - IU	Max.	m	30						
	System	Equivalent Chargeless	m	-	50					
Additional refrigerant charge			kg/m	0.035	30					
	Level difference IU - OU	Max.	m	20.0	See installation manual					
Power supply	Phase/Frequency/Voltage		Hz/V	1~/50 /220-240						
Current - 50Hz	Maximum fuse amps (MFA)		A	-	25	32	-	16		

Contains fluorinated greenhouse gases

# Concealed ceiling unit with medium ESP

Slimmest yet most powerful medium static pressure unit on the market

- > Combination with split outdoor units is ideal for small retail, offices and residential applications
- > Slimmest unit in class, only 245mm (300mm built-in height) and therefore narrow ceiling voids are no longer a challenge
- > Low operation sound level down to 25dBA
- > Medium external static pressure up to 150Pa facilitates using flexible ducts of varying lengths
- > Possibility to change ESP via wired remote control allows optimisation of the supply air volume



### Optimised supply air volume

Automatically selects the most appropriate fan curve to achieve the units' nominal air flow within ±10%

**Why?**  
After installation the real ducting will frequently differ from the initially calculated air flow resistance → the real air flow may be much lower or higher than nominal, leading to a lack of capacity or uncomfortable air temperature. Automatic Airflow Adjustment function will adapt the unit's fan speed to any ducting automatically (10 or more fan curves are available on every model), making installation much faster

More details and final information can be found by scanning or clicking the QR codes.



Efficiency data		FBA + RXM	35A9 + 35R9	50A9 + 50R	60A9 + 60R	
Cooling capacity	Nom.	kW	3.40	5.00	5.70	
Heating capacity	Nom.	kW	4.00	5.50	7.00	
Space cooling	Energy efficiency class		A++			
	Capacity	Pdesign	kW	3.40	5.00	5.70
	SEER			6.23	6.27	5.91
	Annual energy consumption		kWh/a	191	279	336
Space heating (Average climate)	Energy efficiency class		A+			
	Capacity	Pdesign	kW	2.90	4.40	4.60
	SCOP/A			4.07	4.06	4.01
	Annual energy consumption		kWh/a	996	1,517	1,607
Indoor unit		FBA	35A9	50A9	60A9	
Dimensions	Unit	HeightxWidthxDepth	mm		245 x700 x800	245 x1,000 x800
Weight	Unit		kg		28.0	35.0
Air filter	Type		Resin net			
Fan	Air flow rate	Cooling Low/Medium/High	m³/min		10.5 /12.5 /15.0	12.5 /15.0 /18.0
		Heating Low/Medium/High	m³/min		10.5 /12.5 /15.0	12.5 /15.0 /18.0
	External static pressure	Nom./High	Pa		30 /150	
Sound power level	Cooling		dBA		60.0	56.0
Sound pressure level	Cooling	Low/Medium/High	dBA		29.0 /32.0 /35.0	25.0 /28.0 /30.0
	Heating	Low/Medium/High	dBA		29.0 /34.0 /37.0	25.0 /28.0 /31.0
Control systems	Infrared remote control		BRC4C65 / BRC4C66			
	Wired remote control		BRC1H52W/S/K / BRC1E53A / BRC1E53B / BRC1E53C / BRC1D52			
Power supply	Phase/Frequency/Voltage		Hz/V			1~/50/60/220-240/220
Outdoor unit		RXM	35R9	50R	60R	
Dimensions	Unit	HeightxWidthxDepth	mm		552 x840 x350	734 x870 x373
Weight	Unit		kg		32	49.0
Sound pressure level	Cooling	Nom.	dBA		49.0	48.0
	Heating	Nom.	dBA		49.0	48.0
Operation range	Cooling	Ambient Min.~Max.	°CDB		-10 ~50 / 46	
	Heating	Ambient Min.~Max.	°CWB		-20~24	
Refrigerant	Type		R-32			
	GWP		675		675.0	
	Charge	kg/TCO2Eq	0.76 /0.52		1.15 /0.780	
Piping connections	Liquid	OD	mm		6.35	
	Gas	OD	mm		9.50	12.7
	Piping length	OU - IU Max. System Chargeless	m		20	30
			m		10	-
	Additional refrigerant charge		kg/m		0.02 (for piping length exceeding 10m)	
	Level difference	IU - OU Max.	m		15	20.0
Power supply	Phase/Frequency/Voltage		Hz/V			1~/50 /220-240
Current - 50Hz	Maximum fuse amps (MFA)	A	-		16	

Contains fluorinated greenhouse gases

# Concealed ceiling unit with high ESP

ESP up to 250 Pa, ideal for large sized spaces

- › High external static pressure up to 250Pa facilitates extensive duct and grille network
- › Possibility to change ESP via wired remote control allows optimisation of the supply air volume
- › Discretely concealed in the ceiling: only the suction and discharge grilles are visible
- › Built-in drain pump (625mm) increases the flexibility and installation speed (standard for FDA125, optional for FDA200-250)
- › Standard supplied suction filter simplifies installation
- › Up to 26.4kW in heating mode

More details and final information can be found by scanning or clicking the QR codes.

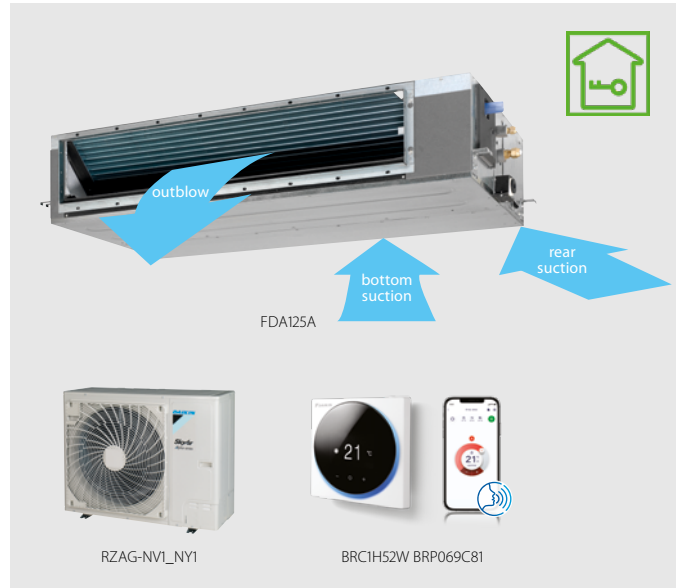

FDA-A



RZAG-NV1



RZAG-NY1



RZASG-MV1



RZASG-MY1

		Sky Air Alpha-series				Sky Air Advance-series		
Efficiency data		FDA + RZAG / RZASG		125A + 125NV1	125A + 125NY1	125A + 125MV1	125A + 125MY1	
Cooling capacity	Nom.					12.1		
Heating capacity	Nom.					13.5		
Space cooling	Capacity	Pdesign				12.1		
	SEER					5.03		
	ηs,c					198		
	Annual energy consumption					1,444		
Space heating (Average climate)	Capacity	Pdesign				6.00		
	SCOP/A					3.58		
	ηs,h					140		
	Annual energy consumption					2,346		
Indoor unit		FDA		125A	125A	125A	125A	
Dimensions	Unit	HeightxWidthxDepth				300 x1,400 x700		
Weight	Unit					45		
Required ceiling void	>					350		
Air filter	Type					Resin net		
Decoration panel	Model					BYBS125DJW1		
	Colour					White (10Y9/0.5)		
	Dimensions	HeightxWidthxDepth				55 x1,500 x500		
Fan	Weight					6.5		
	Air flow rate	Cooling	Low/High			28.0 /39.0		
		Heating	Low/High			28.0 /39.0		
	External static pressure	Nom./High					50 /200	
Sound power level	Cooling					66		
Sound pressure level	Cooling	Low/High					33 /40	
	Heating	Low/High					33 /40	
Control systems	Infrared remote control					BRC4C65 / BRC4C66		
	Wired remote control					BRC1H52W/S/K / BRC1E53A / BRC1E53B / BRC1E53C / BRC1D52		
Power supply	Phase/Frequency/Voltage					1~/50/60/220-240/220		
Outdoor unit		RZAG125NV1		RZAG125NY1	RZASG125MV1	RZASG125MY1		
Dimensions	Unit	HeightxWidthxDepth				870 x1,100 x460		
Weight	Unit					95		
Sound power level	Cooling					69		
	Heating					68		
Sound pressure level	Cooling	Nom.					49	
	Heating	Nom.					52	
Operation range	Cooling	Ambient	Min.~Max.			-20 ~52		
	Heating	Ambient	Min.~Max.			-20 ~18		
Refrigerant	Type/GWP					R-32/675		
	Charge	kg/TCO2Eq				3.70 /2.50		
Piping connections	Liquid/Gas	OD				9.52 /15.9		
	Piping length	OU - IU	Max.			85		
		System	Equivalent			100		
		Chargeless					40	
	Additional refrigerant charge	kg/m				See installation manual		
Level difference IU - OU	Max.				30			
Power supply	Phase/Frequency/Voltage					1~/50 /220-240		
Current - 50Hz	Maximum fuse amps (MFA)					32		
						16		
						32		
						16		

Contains fluorinated greenhouse gases



# Concealed ceiling unit with high ESP

ESP up to 250 Pa, ideal for large sized spaces

- › High external static pressure up to 250Pa facilitates extensive duct and grille network
- › Possibility to change ESP via wired remote control allows optimisation of the supply air volume
- › Discretely concealed in the ceiling: only the suction and discharge grilles are visible
- › Optional drain pump
- › Standard supplied suction filter simplifies installation
- › Up to 26.4kW in heating mode



More details and final information can be found by scanning or clicking the QR codes.



FDA-A



RZA-D

Efficiency data		FDA + RZA		200A + 200D		250A + 250D	
Cooling capacity	Nom.	kW		19.0		22.0	
Heating capacity	Nom.	kW		22.4		24.0	
Space cooling	Capacity	Pdesign		kW		19.0	
	SEER			6.26		5.38	
	ηs,c	%		247		212	
	Annual energy consumption	kWh/a		1,821		2,455	
Space heating (Average climate)	Capacity	Pdesign		kW		11.2	
	SCOP/A			3.59		3.55	
	ηs,h	%		141		139	
	Annual energy consumption	kWh/a		4,368		4,765	
Indoor unit		FDA		200A		250A	
Dimensions	Unit	HeightxWidthxDepth		mm		470 x1,490 x1,100	
Weight	Unit	kg		104		115	
Air filter	Type		Resin net				
Fan	Air flow rate	Cooling	Low/Medium/High	m³/min		36.0 /50 /64.0	
		Heating	Low/Medium/High	m³/min		36.0 /50.0 /64.0	
	External static pressure	Nom./High		Pa		62 /250	
Sound power level	Cooling	dBA		69.0		71.0	
Sound pressure level	Cooling	Low/Medium/High		dBA		36.0 /39.0 /43.0	
	Heating	Low/Medium/High		dBA		36.0 /39.0 /43.0	
Control systems	Wired remote control		BRC1H52W/S/K / BRC1E53A / BRC1E53B / BRC1E53C / BRC1D52				
Power supply	Phase/Frequency/Voltage		Hz/V		1~/50/60/220-240/220		
Outdoor unit		RZA		200D		250D	
Dimensions	Unit	HeightxWidthxDepth		mm		870 x1,100 x460	
Weight	Unit	kg		117			
Sound power level	Cooling	dBA		73		76	
	Heating	dBA		76		79	
Sound pressure level	Cooling	Nom.		dBA		53	
	Heating	Nom.		dBA		60	
Operation range	Cooling	Ambient	Min.~Max.	°CDB		-20 ~46	
	Heating	Ambient	Min.~Max.	°CWB		-20 ~15	
Refrigerant	Type/GWP		R-32/675				
	Charge	kg/TCO2Eq		5 /3.38			
Piping connections	Liquid/Gas OD		mm		9.52 /22.2		
	Piping length	OU - IU	Max.	m		100	
		System	Chargeless	m		30	
	Additional refrigerant charge	kg/m		See installation manual			
Power supply	Phase/Frequency/Voltage		Hz/V		3~/50 /380-415		
Current - 50Hz	Maximum fuse amps (MFA)		A		20		

Contains fluorinated greenhouse gases

# Concealed ceiling unit with medium ESP

Ideal for residential applications with false ceilings

- › Combination with split outdoor units is ideal for small retail, offices or residential applications
- › Slimmest unit in class, only 245mm (300mm built-in height) and therefore narrow ceiling voids are no longer a challenge
- › Low operation sound level down to 25dBA
- › Medium external static pressure up to 150Pa facilitates using flexible ducts of varying lengths
- › Possibility to change ESP via wired remote control allows optimisation of the supply air volume
- › Discretely concealed in the ceiling: only the suction and discharge grilles are visible
- › Multi zoning kit allows multiple individually-controlled climate zones to be served by one indoor unit



## Optimised supply air volume

Automatically selects the most appropriate fan curve to achieve the units' nominal air flow within ±10%

### Why?

After installation the real ducting will frequently differ from the initially calculated air flow resistance → the real air flow may be much lower or higher than nominal, leading to a lack of capacity or uncomfortable air temperature. Automatic Airflow Adjustment function will adapt the unit's fan speed to any ducting automatically (10 or more fan curves are available on every model), making installation much faster

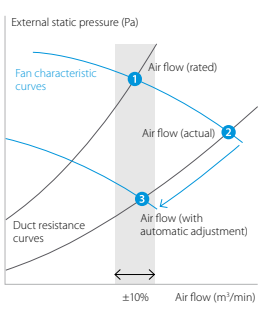

More details and final information can be found by scanning or clicking the QR codes.



Efficiency data		ADEA	71A + ARXM71R	100A + AZAS100MV1	125A + AZAS125MV1	
Cooling capacity	Nom.	kW	6.80	9.50	12.10	
Heating capacity	Nom.	kW	7.50	10.80	13.50	
Space cooling	Energy efficiency class		A	A	-	
	Capacity	Pdesign	kW	6.80	9.50	12.10
	SEER		5.35	5.13	4.73	
	ηs,c		%	-	186	
Annual energy consumption		kWh/a	445	648	1,534	
Space heating (Average climate)	Energy efficiency class			A	-	
	Capacity	Pdesign	kW	6.00	-	
	SCOP/A		3.80	3.81	3.50	
	ηs,h		%	-	137	
	Annual energy consumption		kWh/a	2,209	2,206	2,399
Indoor unit		ADEA	71A	100A	125A	
Dimensions	Unit	HeightxWidthxDpeth	mm	245 x1,400 x800		
Weight	Unit		kg	35.0	46.0	
Air filter	Type			Resin net		
Fan	Air flow rate	Cooling	Low/Medium/High	m³/min	12.5 /15.0 /18.0	
		Heating	Low/Medium/High	m³/min	12.5 /15.0 /18.0	
	External static pressure	Nom./High		Pa	30 /150	
Sound power level	Cooling			dBA	56	
	Heating	Low/Medium/High		dBA	25 /28 /30	
Sound pressure level	Cooling	Low/Medium/High		dBA	25 /28 /31	
	Heating	Low/Medium/High		dBA	25 /28 /31	
Control systems	Infrared remote control			BRC4C65 / BRC4C66		
	Wired remote control			BRC1E53A / BRC1E53B / BRC1E53C / BRC1D52		
Power supply	Phase/Frequency/Voltage		Hz/V	1~/50 /220-240/220		
Outdoor unit		ARXM71R	AZAS100MV1	AZAS125MV1		
Dimensions	Unit	HeightxWidthxDpeth	mm	734 x954 x401		
Weight	Unit		kg	49.0	70	
Sound power level	Cooling			dBA	70	
	Heating			dBA	71	
Sound pressure level	Cooling	Nom.		dBA	52.0	
	Heating	Nom.		dBA	52.0	
Operation range	Cooling	Ambient	Min.~Max.	°CDB	~-~	
	Heating	Ambient	Min.~Max.	°CWB	~-~	
Refrigerant	Type/GWP			R-32/675.0		
	Charge	kg/TCO2Eq		1.15 /0.780	2.60 /1.76	
Piping connections	Liquid/Gas	OD	mm	9.52/15.9		
	Piping length	OU - IU	Max.	m	30	
		System	Equivalent	m	-	
			Chargeless	m	-	
		Additional refrigerant charge		kg/m	0.035 (for piping length exceeding 10m)	
	Level difference	IU - OU	Max.	m	20.0	
Power supply	Phase/Frequency/Voltage		Hz/V	1~/50 /220-240		
Current - 50Hz	Maximum fuse amps (MFA)		A	-	25	

Contains fluorinated greenhouse gases

# Wall mounted unit

For rooms with no false ceilings nor free floor space

- › Combination with Sky Air Alpha-series ensures best in class quality, highest efficiency and performance
- › Flat, stylish front panel blends easily within any interior décor and is easier to clean
- › Can easily be installed in both new and refurbishment projects
- › The air is comfortably spread up- and downwards thanks to 5 different discharge angles that can be programmed via the remote control
- › Maintenance operations can be performed easily from the front of the unit
- › Flexible to install as the largest casing only weighs 18 kg and piping connection can be done at the bottom, left or right of the unit



More details and final information can be found by scanning or clicking the QR codes.



FAA-B



RZAG-NV1



RZAG-NY1

Efficiency data		FAA + RZAG		71B + 71NV1	100B + 100NV1	71B + 71NY1	100B + 100NY1	
Cooling capacity	Nom.	kW		6.80	9.50	6.80	9.50	
Heating capacity	Nom.	kW		7.50	10.8	7.50	10.8	
Space cooling	Energy efficiency class			A++				
	Capacity	Pdesign	kW	6.80	9.50	6.80	9.50	
	SEER			6.58	6.42	6.58	6.42	
	Annual energy consumption		kWh/a	362	518	362	518	
Space heating (Average climate)	Energy efficiency class			A+				
	Capacity	Pdesign	kW	4.70	7.80	4.70	7.80	
	SCOP/A			4.20	4.01	4.20	4.01	
	Annual energy consumption		kWh/a	1,567	2,723	1,567	2,723	
Indoor unit		FAA		71B	100B	71B	100B	
Dimensions	Unit	HeightxWidthxDepth		mm	290x1,050x269	340x1,200x262	290x1,050x269	340x1,200x262
Weight	Unit			kg	14.0	18	14.0	18
Fan	Air flow rate	Cooling	Low/Medium/High	m <sup>3</sup> /min	12.1/13.4/16.2	23.0/21.1/18.7	12.1/13.4/16.2	23.0/21.1/18.7
		Heating	Low/Medium/High	m <sup>3</sup> /min	12.7/14.2/16.9	23.0/20.9/18.7	12.7/14.2/16.9	23.0/20.9/18.7
Sound power level	Cooling			dBA	61.0	65	61.0	65
	Heating			dBA	61.0	65	61.0	65
Sound pressure level	Cooling	Low/Medium/High		dBA	40.0/42.0/45.0	41/45/49	40.0/42.0/45.0	41/45/49
	Heating	Low/Medium/High		dBA	40.0/42.0/45.0	41/45/49	40.0/42.0/45.0	41/45/49
Control systems	Infrared remote control				BRC7EA631	BRC7EA632	BRC7EA631	BRC7EA632
	Wired remote control				BRC1H52W/S/K, BRC1E53A/B/C, BRC1D52			
Power supply	Phase/Frequency/Voltage		Hz/V	1~/50 /220-240				
Outdoor unit		RZAG		71NV1	100NV1	71NY1	100NY1	
Dimensions	Unit	HeightxWidthxDepth		mm	870x1,100x460			
Weight	Unit			kg	81	85	81	85
Sound power level	Cooling			dBA	64	66	64	66
Sound pressure level	Cooling	Nom.		dBA	46	47	46	47
	Heating	Nom.		dBA	48	50	48	50
Operation range	Cooling	Ambient	Min.~Max.	°CDB	-20~-52			
	Heating	Ambient	Min.~Max.	°CWB	-20~-18			
Refrigerant	Type/GWP				R-32/675			
	Charge			kg/TCO2Eq	3.20/2.16			
Piping connections	Liquid/Gas OD			mm	9.52/15.9			
	Piping length	OU - IU	Max.	m	55	85	55	85
		System	Equivalent	m	75	100	75	100
			Chargeless		m	40		
	Additional refrigerant charge			kg/m	See installation manual			
Level difference IU - OU		Max.		m	30			
Power supply	Phase/Frequency/Voltage		Hz/V	1~/50 /220-240		3~/50 /380-415		
Current - 50Hz	Maximum fuse amps (MFA)		A	20	32	16		

Contains fluorinated greenhouse gases

# Wall mounted unit

For rooms with no false ceilings nor free floor space

- › Combination with Sky Air Advance-series ensures good value for money for all types of commercial applications
- › Flat, stylish front panel blends easily within any interior décor and is easier to clean
- › Can easily be installed in both new and refurbishment projects
- › The air is comfortably spread up- and downwards thanks to 5 different discharge angles that can be programmed via the remote control
- › Maintenance operations can be performed easily from the front of the unit
- › Flexible to install as the largest casing only weighs 18 kg and piping connection can be done at the bottom, left or right of the unit



More details and final information can be found by scanning or clicking the QR codes.



FAA-B



RZASG-MV1



RZASG-MY1

Efficiency data		FAA + RZASG		71B + 71MV1		100B + 100MV1		100B + 100MY1			
Cooling capacity	Nom.	kW		6.80				9.50			
Heating capacity	Nom.	kW		7.50				10.8			
Space cooling	Energy efficiency class			A++				A+			
	Capacity	Pdesign	kW		6.80				9.50		
	SEER			6.41				5.83			
	Annual energy consumption			kWh/a		371				570	
Space heating (Average climate)	Energy efficiency class					A					
	Capacity	Pdesign	kW		4.50				6.00		
	SCOP/A			3.90						3.85	
	Annual energy consumption			kWh/a		1,615				2,182	

Indoor unit		FAA		71B		100B				
Dimensions	Unit	HeightxWidthxDPTH		mm		290x1,050x269		340x1,200x262		
Weight	Unit	kg		14.0		18				
Fan	Air flow rate	Cooling	Low/Medium/High	m³/min		12.1/13.4/16.2		23.0/21.1/18.7		
		Heating	Low/Medium/High	m³/min		12.7/14.2/16.9		23.0/20.9/18.7		
Sound power level	Cooling	dBA		61.0		65				
	Heating	dBA		61.0		65				
Sound pressure level	Cooling	Low/Medium/High	dBA		40.0/42.0/45.0		41/45/49			
	Heating	Low/Medium/High	dBA		40.0/42.0/45.0		41/45/49			
Control systems	Infrared remote control			BRC7EA631		BRC7EA632				
	Wired remote control					BRC1H52W/S/K, BRC1E53A/B/C, BRC1D52				
Power supply	Phase/Frequency/Voltage		Hz/V		1~/50 /220-240					

Outdoor unit		RZASG		71MV1		100MV1		100MY1			
Dimensions	Unit	HeightxWidthxDPTH		mm		770x900x320		990x940x320			
Weight	Unit	kg		60		70					
Sound power level	Cooling			dBA		65		70			
	Sound pressure level			dBA		46		53			
Operation range	Cooling	Ambient	Min.~Max.	°CDB		-15~46					
	Heating	Ambient	Min.~Max.	°CWB		-15~15.5					
Refrigerant	Type/GWP					R-32/675					
	Charge			kg/TCO2Eq		2.45/1.65		2.60/1.76			
Piping connections	Liquid/ Gas	OD		mm		9.52/15.9					
	Piping length	OU - IU	Max.	m		50					
		System	Equivalent	m		70					
	Chargeless			m		30					
Additional refrigerant charge			kg/m		See installation manual						
Level difference IU - OU			Max.		m		30.0				
Power supply	Phase/Frequency/Voltage		Hz/V		1~/50 /220-240				3~/50 /380-415		
Current - 50Hz	Maximum fuse amps (MFA)			A		20		25		16	

Contains fluorinated greenhouse gases

# Wall mounted unit

For rooms with no false ceilings nor free floor space

- › Ideal solution for small businesses and shops
- › Flat, stylish front panel blends easily within any interior décor and is easier to clean
- › Can easily be installed in both new and refurbishment projects
- › The air is comfortably spread up- and downwards thanks to 5 different discharge angles that can be programmed via the remote control
- › Maintenance operations can be performed easily from the front of the unit
- › Flexible to install as the largest casing only weighs 18 kg and piping connection can be done at the bottom, left or right of the unit



More details and final information can be found by scanning or clicking the QR codes.



FAA-B



ARXM-R



AZAS-MV1



AZAS-MY1

Efficiency data				FAA	71B + ARXM71R	71B + AZAS71MV1	100B + AZAS100MV1	AZAS100B + 100MY1
Cooling capacity	Nom.		kW		6.80	6.80		9.50
Heating capacity	Nom./		kW		7.50	7.50		10.8
Power input	Cooling	Nom.	kW		2.00		-	
	Heating	Nom.	kW		2.35		-	
Space cooling	Energy efficiency class					A+		A
	Capacity	Pdesign	kW		6.80			9.50
	SEER					5.77		5.25
	Annual energy consumption		kWh/a			412		633
Space heating (Average climate)	Energy efficiency class						A	
	Capacity	Pdesign	kW		4.50			6.00
	SCOP/A						3.81	
	Annual energy consumption		kWh/a		1,652	1,654		2,205
Indoor unit				FAA	71B		100B	
Dimensions	Unit	HeightxWidthxD	mm		290x1,050x269		340x1,200x262	
Weight	Unit		kg		14.0		18	
Fan	Air flow rate	Cooling	Low/Medium/High m <sup>3</sup> /min		12.1/13.4/16.2		23.0/21.1/18.7	
		Heating	Low/Medium/High m <sup>3</sup> /min		12.7/14.2/16.9		23.0/20.9/18.7	
Sound power level	Cooling		dBA		61.0		65	
	Heating		dBA		61.0		65	
Sound pressure level	Cooling	Low/Medium/High	dBA		40.0/42.0/45.0		41/45/49	
	Heating	Low/Medium/High	dBA		40.0/42.0/45.0		41/45/49	
Control systems	Infrared remote control				BRC7EA631		BRC7EA632	
	Wired remote control				BRC1H52W/S/K, BRC1E53A/B/C, BRC1D52			
Power supply	Phase/Frequency/Voltage		Hz/V		1~/50 /220-240			
Outdoor unit				ARXM	71R	71MV1	100MV1	100MY1
Dimensions	Unit	HeightxWidthxD	mm		734x954x401	770x900x320		990x940x320
Weight	Unit		kg		49.0	60		70
Sound power level	Cooling		dBA		-	65		70
Sound pressure level	Cooling	Nom.	dBA		52.0	46		53
	Heating	Nom.	dBA		52.0	47		57
Operation range	Cooling	Ambient	Min.~Max.	°CDB	-10~46			-5~46
	Heating	Ambient	Min.~Max.	°CWB	-			-15~15.5
Refrigerant	Type/ GWP				R-32/675.0			
	Charge		kg/TCO2Eq		1.15/0.780	2.45/1.65		2.60/1.76
Piping connections	Liquid/Gas OD		mm		9.52/15.9			
	Piping length	OU - IU	Max.	m	30			
		System	Equivalent	m	-	50		
			Chargeless	m	-	30		
	Additional refrigerant charge		kg/m		0.035 <small>(for piping length exceeding 10m)</small>	See installation manual		
Level difference	IU - OU	Max.	m	20.0	30.0			
Power supply	Phase/Frequency/Voltage		Hz/V		1~/50 /220-240		3~/50 /380-415	
Current - 50Hz	Maximum fuse amps (MFA)		A		-	20	25	16

Contains fluorinated greenhouse gases

## Wall mounted unit

Attractive, wall mounted design with perfect indoor air quality

- › Combination with Sky Air Alpha-series ensures best in class quality, highest efficiency and performance
- › Seasonal efficiency values up to A+++ in cooling and heating
- › Practically inaudible: the unit runs so quietly, you will almost forget it is there
- › Cleaner air thanks to Daikin's Flash Streamer technology: you can breathe deep with no worries about impure air
- › 2-area motion detection sensor: air flow is sent to a zone other than where the person is located at that moment; if no people are detected, the unit will automatically switch over to the energy-efficient setting. (larger capacity area)
- › Onecta app: control your indoor from any location with an app, via your local network or internet
- › Sleek, unobtrusive air conditioning unit that matches European sensibilities regarding interior design
- › 3-D air flow combines vertical and horizontal auto swing to circulate a stream of warm or cool air right to the corners of even large spaces



More details and final information can be found by scanning or clicking the QR codes.



FTXM-R



RZAG-A

Efficiency data		FTXM + RZAG		35R + 35A		50R + 50A		60R + 60A			
Cooling capacity	Min./Nom./Max.	kW		1.6/3.5/5.0		1.7/5.0/6.0		1.7/6.0/6.8			
Heating capacity	Min./Nom./Max.	kW		1.40/4.00/5.30		1.50/6.00/6.50		1.60/7.00/7.50			
Space cooling	Energy efficiency class					A++					
	Capacity	Pdesign	kW	3.50		5.00		6.00			
	SEER			7.70		7.41		6.90			
	Annual energy consumption			kWh/a		159		236			
Space heating (Average climate)	Energy efficiency class					A++		A+			
	Capacity	Pdesign	kW	2.60		4.50		4.60			
	SCOP/A			4.60		4.35		4.35			
	Annual energy consumption			kWh/a		790		1,369			
<b>Indoor unit</b>		<b>FTXM</b>		<b>35R</b>		<b>50R</b>		<b>60R</b>			
Dimensions	Unit	HeightxWidthxDepth		mm		295x778x272		299x998x292			
Weight	Unit	kg		10.0		14.5					
Air filter	Type		Removable/washable								
Fan	Air flow rate	Cooling	Silent operation/ Low/Medium/High	m <sup>3</sup> /min	4.2/6.0/7.8/11.3		8.3/11.4/14/15.8		9.1/11.8/14/16.7		
		Heating	Silent operation/ Low/Medium/High	m <sup>3</sup> /min	4.9/6.5/8.5/9.8		10.5/12.0/14.2/15.8		11.1/12.4/15.2/16.5		
Sound power level	Cooling	dBA		58		58.0		60.0			
	Heating	dBA		54		58.0		59.0			
Sound pressure level	Cooling	Silent operation/Low/High		dBA	19/29/45		27.0/36.0/44.0		30.0/37.0/46.0		
	Heating	Silent operation/Low/High		dBA	20/28/39		31.0/34.0/43.0		33.0/36.0/45.0		
Control systems	Infrared remote control					ARC466A67					
	Wired remote control					BRC073A1					
<b>Outdoor unit</b>		<b>RZAG</b>		<b>35A</b>		<b>50A</b>		<b>60A</b>			
Dimensions	Unit	HeightxWidthxDepth		mm		734x870x373					
Weight	Unit	kg		52							
Sound power level	Cooling	dBA		62.0		63.0		64.0			
	Heating	dBA		62.0		63.0		64.0			
Sound pressure level	Cooling	Nom.	dBA	48.0		49.0		50.0			
	Heating	Nom.	dBA	48.0		49.0		50.0			
Operation range	Cooling	Ambient	Min.~Max.	°CDB	-20~-52						
	Heating	Ambient	Min.~Max.	°CWB	-20~-24						
Refrigerant	Type/GWP			R-32/675.0							
	Charge			kg/TCO <sub>2</sub> Eq		1.55/1.05					
Piping connections	OD		mm		6.35 /9.50		6.35 /12.7				
	Piping length	OU - IU	Max.	m	50						
		System	Chargeless	m	30						
	Additional refrigerant charge			kg/m		0.02 (for piping length exceeding 30m)					
	Level difference IU - OU		Max.	m	30.0						
Power supply	Phase/Frequency/Voltage		Hz/V		1~/50 /220-240						

Contains fluorinated greenhouse gases

# Ceiling suspended unit

For wide rooms with no false ceilings nor free floor space

- › Combination with Sky Air Advance-series ensures good value for money for all types of commercial applications
- › Ideal for comfortable air flow in wide rooms thanks to Coanda effect: up to 100° discharge angle

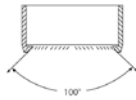

- › Even rooms with ceilings up to 3.8m can be heated up or cooled down very easily without capacity loss
- › Can easily be installed in both new and refurbishment projects
- › Can easily be mounted in corners and narrow spaces, as it only needs 30mm lateral service space

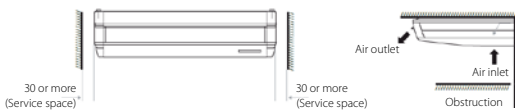

- › Reduced energy consumption thanks to specially developed DC fan motor
- › 5 different fan speeds available for maximum comfort



More details and final information can be found by scanning or clicking the QR codes.

FHA-A(9)

RZAG-A

RZAG-NV1

RZAG-NY1

Efficiency data		FHA + RZAG	35A9 + 35A	50A9 + 50A	60A9 + 60A	71A9 + 71NV1	100A + 100NV1	125A + 125NV1	140A + 140NV1	71A9 + 71NY1	100A + 100NY1	125A + 125NY1	140A + 140NY1	
Cooling capacity	Min./Nom./Max.	kW	1.70/3.50/4.50	1.70/5.00/6.00	1.90/6.00/6.80	-/6.80/-	-/9.50/-	-/12.1/-	-/13.4/-	-/6.80/-	-/9.50/-	-/12.1/-	-/13.4/-	
Heating capacity	Min./Nom./Max.	kW	1.40/4.00/5.50	1.70/5.80/6.50	1.70/7.00/7.50	-/7.50/-	-/10.8/-	-/13.5/-	-/15.5/-	-/7.50/-	-/10.8/-	-/13.5/-	-/15.5/-	
Space cooling	Energy efficiency class		A++				-				A++			
	Capacity	Pdesign	kW	3.50	5.00	6.00	6.80	9.50	12.1	13.4	6.80	9.50	12.1	13.4
	SEER		6.40	6.80	6.60	7.11	6.42	7.14	6.42	7.11	6.42	7.14	6.42	
	ηs,c		-				283				254			
	Annual energy consumption		kWh/a	191	257	318	335	518	1,017	1,253	335	518	1,017	1,253
Space heating	Energy efficiency class		A+				A++				A+			
(Average climate)	Capacity	Pdesign	kW	3.10	4.00	4.60	4.70	7.80	9.52	4.70	7.80	9.52	9.52	
	SCOP/A		4.10	4.30	4.20	4.32	4.61	4.20	4.30	4.32	4.61	4.20	4.30	
	ηs,h		-				165				169			
	Annual energy consumption		kWh/a	1,058	1,302	1,633	1,523	2,369	3,174	3,100	1,523	2,369	3,174	3,100

Indoor unit		FHA	35A9	50A9	60A9	71A9	100A	125A	140A	71A9	100A	125A	140A
Dimensions	Unit	HeightxWidthxDepth	mm										
			235x960x690										
Weight	Unit		kg										
			24.0 25.0 31.0 32.0 38.0 32.0 38.0										
Air filter	Type		Resin net										
Fan	Air flow rate	Cooling	Low/Medium/High	m³/min									
		Heating	Low/Medium/High	m³/min									
Sound power level	Cooling		dBA	53 54 55 60 62 64 55 60 62 64									
Sound pressure level	Cooling	Low/Medium/High	dBA	31/34/36 32/35/37 33/35/37 34/36/38 34/38/42 37/41/44 38/42/46 34/36/38 34/38/42 37/41/44 38/42/46									
	Heating	Medium/Nom./High	dBA	31/34/36 32/35/37 33/35/37 34/36/38 34/38/42 37/41/44 38/42/46 34/36/38 34/38/42 37/41/44 38/42/46									
Control systems	Infrared remote control		BRC7GA53 / BRC7GA56										
	Wired remote control		BRC1H51W/S/K / BRC1E53A/B/C / BRC1D52										
Power supply	Phase/Frequency/Voltage		Hz/V										
			1~/50 / 220-240										

Outdoor unit		RZAG	35A	50A	60A	71NV1	100NV1	125NV1	140NV1	71NY1	100NY1	125NY1	140NY1
Dimensions	Unit	HeightxWidthxDepth	734x870x373				870x1,100x460						
Weight	Unit		kg				kg						
			52				81 85 95 81 85 94						
Sound power level	Cooling		dBA										
	Heating		dBA										
Sound pressure level	Cooling	Nom.	dBA										
	Heating	Nom.	dBA										
Operation range	Cooling	Ambient	Min.~Max.	°CDB									
	Heating	Ambient	Min.~Max.	°CWB									
Refrigerant	Type/GWP		R-32/675.0				R-32/675						
	Charge		kg/TCO2Eq				kg/TCO2Eq						
Piping connections	Liquid/Gas OD		mm				mm						
	Piping length	OU - IU Max. System Equivalent	m				m						
		Chargeless	m				m						
	Additional refrigerant charge		kg/m				kg/m						
			30.0				See installation manual						
	Level difference	IU - OU Max.	m				m						
Power supply	Phase/Frequency/Voltage		Hz/V				Hz/V						
Current - 50Hz	Maximum fuse amps (MFA)		A				A						

Contains fluorinated greenhouse gases

# Ceiling suspended unit

For wide rooms with no false ceilings nor free floor space

- › Combination with Sky Air Advance-series ensures good value for money for all types of commercial applications
- › Ideal for comfortable air flow in wide rooms thanks to Coanda effect: up to 100° discharge angle
- › Even rooms with ceilings up to 3.8m can be heated up or cooled down very easily without capacity loss
- › Can easily be installed in both new and refurbishment projects
- › Can easily be mounted in corners and narrow spaces, as it only needs 30mm lateral service space
- › 5 different fan speeds available for maximum comfort
- › Stylish unit blends easily with any interior. The flaps close entirely when the unit is not operating and there are no air intake grilles visible



More details and final information can be found by scanning or clicking the QR codes.



FHA-A(9)



RZASG-MV1



RZASG-MY1

Efficiency data		FHA + RZASG		71A9 + 71MV1	100A + 100MV1	125A + 125MV1	140A + 140MV1	100A + 100MY1	125A + 125MY1	140A + 140MY1			
Cooling capacity	Nom.	kW		6.80	9.50	12.1	13.4	9.50	12.1	13.4			
Heating capacity	Nom.	kW		7.50	10.8	13.5	15.5	10.8	13.5	15.5			
Space cooling	Energy efficiency class			A+		-		A+		-			
	Capacity	Pdesign		kW		6.80	9.50	12.1	13.4	9.50	12.1	13.4	
	SEER			5.95	5.83	5.88	5.88	5.83	5.88	5.88			
	ηs,c	%		-	230	232	-	230	232				
Space heating (Average climate)	Annual energy consumption			kWh/a		400	570	1,246	1,368	570	1,246	1,368	
	Energy efficiency class			A		-		A		-			
	Capacity	Pdesign		kW		4.50	6.00	7.80	6.00	7.80			
	SCOP/A			3.90	3.91	3.83	3.81	3.91	3.83	3.81			
	ηs,h	%		-	150	149	-	150	149				
	Annual energy consumption			kWh/a		1,616	2,148	2,193	2,866	2,148	2,193	2,866	
Indoor unit		FHA		71A9	100A	125A	140A	100A	125A	140A			
Dimensions	Unit	HeightxWidthxDepth		mm		235x1,270x690	235x1,590x690						
Weight	Unit	kg		32.0	38.0								
Air filter	Type		Resin net										
Fan	Air flow rate	Cooling	Low/Medium/High		m³/min		14.0/17.0/20.5	20.0/24.0/28.0	23.0/27.0/31.0	24.0/29.0/34.0	20.0/24.0/28.0	23.0/27.0/31.0	24.0/29.0/34.0
		Heating	Low/Medium/High		m³/min		14.0/17.0/20.5	20.0/24.0/28.0	23.0/27.0/31.0	24.0/29.0/34.0	20.0/24.0/28.0	23.0/27.0/31.0	24.0/29.0/34.0
Sound power level	Cooling	dBA		55	60	62	64	60	62	64			
Sound pressure level	Cooling	Low/Medium/High		dBA		34/36/38	34/38/42	37/41/44	38/42/46	34/38/42	37/41/44	38/42/46	
	Heating	Medium/Nom./High		dBA		34/36/38	34/38/42	37/41/44	38/42/46	34/38/42	37/41/44	38/42/46	
Control systems	Infrared remote control			BRC7GA53 / BRC7GA56									
	Wired remote control			BRC1E53A7 / BRC1E53B7 / BRC1E53C7 / BRC1D528 / BRC1E51A7									
Power supply	Phase/Frequency/Voltage		Hz/V		1~/50 /220-240								
Outdoor unit		RZASG		71MV1	100MV1	125MV1	140MV1	100MY1	125MY1	140MY1			
Dimensions	Unit	HeightxWidthxDepth		mm		770x900x320	990x940x320						
Weight	Unit	kg		60	70	78	78	70	71	77			
Sound power level	Cooling	dBA		65	70	71	73	70	71	73			
	Heating	dBA		-	71	73	-	71	73				
Sound pressure level	Cooling	Nom.	dBA		46	53	54	53	54				
	Heating	Nom.	dBA		47	57	57	57	54				
Operation range	Cooling	Ambient	Min.~Max.		°CDB		-15~46						
	Heating	Ambient	Min.~Max.		°CWB		-15~-15.5						
Refrigerant	Type/GWP			R-32/675									
	Charge			kg/TCO2Eq		2.45/1.65	2.60/1.76	2.90/1.96	2.60/1.76	2.90/1.96			
Piping connections	Liquid/Gas OD			mm		9.52/15.9							
	Piping length	OU - IU	Max.		m		50						
		System	Equivalent Chargeless		m		70						
	Additional refrigerant charge			kg/m		See installation manual							
Level difference IU - OU			Max.		m		30.0						
Power supply	Phase/Frequency/Voltage		Hz/V		1~/50 /220-240				3~/50 /380-415				
Current - 50Hz	Maximum fuse amps (MFA)			A		20	25	32	16				

Contains fluorinated greenhouse gases



# Ceiling suspended unit

For wide rooms with no false ceilings nor free floor space

- › Combination with split outdoor units is ideal for small retail, offices and residential applications
- › Ideal for comfortable air flow in wide rooms thanks to Coanda effect: up to 100° discharge angle
- › Even rooms with ceilings up to 3.8m can be heated up or cooled down very easily without capacity loss
- › Can easily be installed in both new and refurbishment projects
- › Can easily be mounted in corners and narrow spaces, as it only needs 30mm lateral service space
- › 5 different fan speeds available for maximum comfort
- › Stylish unit blends easily with any interior. The flaps close entirely when the unit is not operating and there are no air intake grilles visible



More details and final information can be found by scanning or clicking the QR codes.



FHA-A(9)



RXM-R



RXM-R9

Efficiency data		FHA + RXM		35A9 + 35R9		50A9 + 50R		60A9 + 60R	
Cooling capacity	Nom.	kW		3.40		5.00		5.70	
Heating capacity	Nom.	kW		4.00		6.00		7.20	
Space cooling	Energy efficiency class			A++				A+	
	Capacity	Pdesign		kW		3.40		5.00	
	SEER			6.24		5.92		6.08	
	Annual energy consumption			kWh/a		191		295	
Space heating (Average climate)	Energy efficiency class			A+				A	
	Capacity	Pdesign		kW		3.10		4.35	
	SCOP/A			4.43		3.86		3.87	
	Annual energy consumption			kWh/a		979		1,577	
Indoor unit		FHA		35A9		50A9		60A9	
Dimensions	Unit	HeightxWidthxDpeth		mm		235x960x690		235x1,270x690	
Weight	Unit	kg		24.0		25.0		31.0	
Air filter	Type		Resin net						
Fan	Air flow rate	Cooling	Low/Medium/High	m <sup>3</sup> /min		10.0/11.5/14.0		10.0/12.0/15.0	
	Heating	Low/Medium/High	m <sup>3</sup> /min		10.0/11.5/14.0		10.0/12.0/15.0		11.5/15.0/19.5
Sound power level	Cooling	dBA		53				54	
Sound pressure level	Cooling	Low/Medium/High		dBA		31/34/36		32/35/37	
	Heating	Medium/Nom./High		dBA		31/34/36		32/35/37	
Control systems	Infrared remote control			BRC7GA53 / BRC7GA56					
	Wired remote control			BRC1E53A7 / BRC1E53B7 / BRC1E53C7 / BRC1D528 / BRC1E51A7					
Power supply	Phase/Frequency/Voltage		Hz/V		1~/50 / 220-240				
Outdoor unit		RXM		35R9		50R		60R	
Dimensions	Unit	HeightxWidthxDpeth		mm		552x840x350		734x954x401	
Weight	Unit	kg		32				49.0	
Sound power level	Cooling	dBA		61		62		63	
	Heating	dBA		61		62		63	
Sound pressure level	Cooling	Nom.	dBA		49.0		48.0		
	Heating	Nom.	dBA				49.0		
Operation range	Cooling	Ambient	Min.~Max.	°CDB		-10~-50/46			
	Heating	Ambient	Min.~Max.	°CWB		-20~-24			
Refrigerant	Type		R-32						
	GWP		675				675.0		
	Charge		kg/TCO <sub>2</sub> Eq		0.76/0.52		1.15/0.780		
Piping connections	Liquid	OD	mm		6.35		6		
	Gas	OD	mm		9.50		12.7		
	Piping length	OU - IU	Max.		m		20		
		System	Chargeless		m		10		
	Additional refrigerant charge		kg/m		0.02 (for piping length exceeding 10m)				
Level difference IU - OU	Max.		m		15		20.0		
Power supply	Phase/Frequency/Voltage		Hz/V		1~/50 / 220-240				
Current - 50Hz	Maximum fuse amps (MFA)		A		13		16		

Contains fluorinated greenhouse gases

# 4-way blow ceiling suspended unit

Unique Daikin unit for high rooms with no false ceilings nor free floor space

- › Combination with Sky Air Advance-series ensures good value for money for all types of commercial applications
- › Even rooms with ceilings up to 3.5m can be heated up or cooled down very easily without capacity loss
- › Can easily be installed in both new and refurbishment projects
- › Unified indoor unit range for R-32 and R-410A
- › Individual flap control: flexibility to suit every room layout without changing the location of the unit!



- › 5 different discharge angles between 0 and 60° can be programmed via the remote control

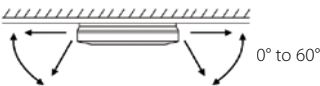

More details and final information can be found by scanning or clicking the QR codes.



FUA-A



RZAG-NV1



RZAG-NY1



- › Stylish modern casing finished in pure white (RAL9010) and iron grey (RAL7011) blends easily with any interior
- › Optimum comfort guaranteed with automatic air flow adjustment to the required load
- › Standard drain pump with 720mm lift increases flexibility and installation speed

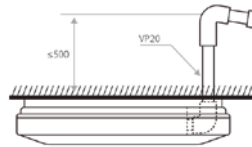

Efficiency data		FUA + RZAG	71A + 71NV1	100A + 100NV1	125A + 125NV1	71A + 71NY1	100A + 100NY1	125A + 125NY1	
Cooling capacity	Nom.	kW	6.80	9.50	12.1	6.80	9.50	12.1	
Heating capacity	Nom.	kW	7.50	10.8	13.5	7.50	10.8	13.5	
Space cooling	Energy efficiency class		A++		-	A++		-	
	Capacity	Pdesign	kW	6.80	9.50	12.1	6.80	9.50	
	SEER			7.02	6.42	6.39	7.02	6.42	
	ηs,c		%	-	-	253	-	253	
Annual energy consumption		kWh/a	339	518	1,136	339	518	1,136	
Space heating (Average climate)	Energy efficiency class		A+		-	A+		-	
	Capacity	Pdesign	kW	4.70	7.80	9.52	4.70	7.80	
	SCOP/A			4.20	4.50	4.26	4.20	4.50	
	ηs,h		%	-	-	167	-	167	
Annual energy consumption		kWh/a	1,567	2,427	3,129	1,567	2,427	3,129	
Indoor unit		FUA	71A	100A	125A	71A	100A	125A	
Dimensions	Unit	HeightxWidthxDepth	198x950x950						
Weight	Unit	kg	25.0	26.0		25.0	26.0		
Air filter	Type		Resin net						
Fan	Air flow rate	Cooling	Low/Medium/High	m³/min	16.0/19.5/23.0	20.0/25.5/31.0	20.5/26.5/32.5	16.0/19.5/23.0	20.0/25.5/31.0
	Heating	Low/Medium/High	m³/min	16.0/19.5/23.0	20.0/25.5/31.0	20.5/26.5/32.5	16.0/19.5/23.0	20.0/25.5/31.0	
Sound power level	Cooling			dBA	-	65	-	65	
	Heating			dBA	35/38/41	39/42/46	40/43/47	35/38/41	39/42/46
Sound pressure level	Cooling	Low/Medium/High		dBA	35/38/41	39/42/46	40/43/47	35/38/41	39/42/46
	Heating	Low/Medium/High		dBA	35/38/41	39/42/46	40/43/47	35/38/41	39/42/46
Control systems	Infrared remote control		BRC7C58						
	Wired remote control		BRC1H52W/S/K / BRC1E53A/B/C / BRC1D52						
Power supply	Phase/Frequency/Voltage		1~/50/220~240						
Outdoor unit		RZAG	71NV1	100NV1	125NV1	71NY1	100NY1	125NY1	
Dimensions	Unit	HeightxWidthxDepth	870x1,100x460						
Weight	Unit	kg	81	85	95	81	85	94	
Sound power level	Cooling		dBA	64	66	69	64	66	
	Heating		dBA	-	-	68	-	68	
Sound pressure level	Cooling	Nom.	dBA	46	47	49	46	47	
	Heating	Nom.	dBA	48	50	52	48	50	
Operation range	Cooling	Ambient	Min.~Max.	-20~-52					
	Heating	Ambient	Min.~Max.	-20~-18					
Refrigerant	Type/GWP		R-32/675						
	Charge		kg/TCO2Eq	3.20/2.16		3.70/2.50		3.20/2.16	
Piping connections	Liquid/Gas OD		9.52/15.9						
	Piping length	OU - IU Max. System	m	55	85		55	85	
		Equivalent Chargeless	m	75	100		75	100	
		Additional refrigerant charge	kg/m	40					
		Level difference IU - OU Max.	m	See installation manual					
Power supply	Phase/Frequency/Voltage		1~/50 /220-240				3~/50 /380-415		
	Current - 50Hz		Maximum fuse amps (MFA)		A		16		

Contains fluorinated greenhouse gases

# 4-way blow ceiling suspended unit

Unique Daikin unit for high rooms with no false ceilings nor free floor space

- › Combination with Sky Air Advance-series ensures good value for money for all types of commercial applications
- › Even rooms with ceilings up to 3.5m can be heated up or cooled down very easily without capacity loss
- › Can easily be installed in both new and refurbishment projects
- › Individual flap control: flexibility to suit every room layout without changing the location of the unit!
- › 5 different discharge angles between 0 and 60° can be programmed via the remote control
- › Stylish modern casing finished in pure white (RAL9010) and iron grey (RAL7011) blends easily with any interior
- › Optimum comfort guaranteed with automatic air flow adjustment to the required load
- › Standard drain pump with 720mm lift increases flexibility and installation speed



More details and final information can be found by scanning or clicking the QR codes.



FUA-A



RZASG-MV1



RZASG-MY1

Efficiency data		FUA + RZASG		71A + 71MV1	100A + 100MV1	125A + 125MV1	100A + 100MY1	125A + 125MY1	
Cooling capacity	Nom.	kW		6.80	9.50	12.1	9.50	12.1	
Heating capacity	Nom.	kW		7.50	10.8	13.5	10.8	13.5	
Space cooling	Energy efficiency class			A++	A+	-	A+	-	
	Capacity	Pdesign kW		6.80	9.50	12.1	9.50	12.1	
	SEER			6.16	5.83	5.49	5.83	5.49	
	ηs,c	%		-	-	217	-	217	
	Annual energy consumption			386	570	1,322	570	1,322	
Space heating (Average climate)	Energy efficiency class			A	A+	-	A+	-	
	Capacity	Pdesign kW		4.50	6.00				
	SCOP/A			3.90	4.01	3.84	4.01	3.84	
	ηs,h	%		-	-	151	-	151	
	Annual energy consumption			1,615	2,095	2,188	2,095	2,188	
Indoor unit		FUA		71A	100A	125A	100A	125A	
Dimensions	Unit	HeightxWidthxDepth		mm		198x950x950			
Weight	Unit	kg		25.0	26.0				
Air filter	Type	Resin net							
Fan	Air flow rate	Cooling	Low/Medium/High	m³/min	16.0/19.5/23.0	20.0/25.5/31.0	20.5/26.5/32.5	20.0/25.5/31.0	20.5/26.5/32.5
	Heating	Low/Medium/High	m³/min	16.0/19.5/23.0	20.0/25.5/31.0	20.5/26.5/32.5	20.0/25.5/31.0	20.5/26.5/32.5	
Sound power level	Cooling	dBA		-	65		-	65	
Sound pressure level	Cooling	Low/Medium/High	dBA	35/38/41	39/42/46	40/43/47	39/42/46	40/43/47	
	Heating	Low/Medium/High	dBA	35/38/41	39/42/46	40/43/47	39/42/46	40/43/47	
Control systems	Infrared remote control			BRC7C58					
	Wired remote control			BRC1H52W/S/K / BRC1E53A/B/C / BRC1D52					
Power supply	Phase/Frequency/Voltage		Hz/V	1~/50/220-240					
Outdoor unit		RZASG		71MV1	100MV1	125MV1	100MY1	125MY1	
Dimensions	Unit	HeightxWidthxDepth		mm		770x900x320			
Weight	Unit	kg		60	70				
Sound power level	Cooling	dBA		65	70	71	70	71	
	Heating	dBA		-	-	71	-	71	
Sound pressure level	Cooling	Nom.	dBA	46	53				
	Heating	Nom.	dBA	47	57				
Operation range	Cooling	Ambient	Min.~Max.	°CDB		-15~46			
	Heating	Ambient	Min.~Max.	°CWB		-15~-15.5			
Refrigerant	Type/GWP			R-32/675					
	Charge			kg/TCO2Eq	2.45/1.65	2.60/1.76			
Piping connections	Liquid/Gas OD			mm		9.52 /15.9			
	Piping length	OU - IU	Max.	m		50			
	System	Equivalent	Chargeless	m		70			
	Additional refrigerant charge			kg/m	See installation manual				
	Level difference IU - OU			Max.	m		30.0		
Power supply	Phase/Frequency/Voltage		Hz/V	1~/50 /220-240			3~/50 /380-415		
Current - 50Hz	Maximum fuse amps (MFA)			A	20	25	32	16	

Contains fluorinated greenhouse gases

# Floor standing unit

For commercial spaces with high ceilings

- › Combination with Sky Air Alpha-series ensures best in class quality, highest efficiency and performance
- › Decrease of temperature variation by automatic fan speed selection or freely selectable 3-step fan speed.
- › Improved comfort as a result of better airflow distribution from the vertical out blow which allows manual adjustment of air outlet blades at the top of the unit.
- › Selectable horizontal out blow to better suit the layout of the room (via wired remote controller BRC1E\*/BRC1H\*)

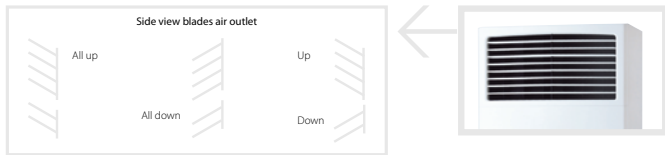

More details and final information can be found by scanning or clicking the QR codes.



FVA-A



RZAG-NV1



RZAG-NY1

Efficiency data			FVA + RZAG									
			71A + 71NV1	100A + 100NV1	125A + 125NV1	140A + 140NV1	71A + 71NY1	100A + 100NY1	125A + 125NY1	140A + 140NY1		
Cooling capacity	Nom.	kW	6.80	9.50	12.1	13.4	6.80	9.50	12.1	13.4		
Heating capacity	Nom.	kW	7.50	10.8	13.5	15.5	7.50	10.8	13.5	15.5		
Space cooling	Energy efficiency class		A++				-					
	Capacity	Pdesign	kW	6.80	9.50	12.1	13.4	6.80	9.50	12.1	13.4	
	SEER			6.34	6.40	6.41	6.12	6.34	6.40	6.41	6.12	
	ηs,c		%	-	-	253	242	-	-	253	242	
Annual energy consumption		kWh/a	376	520	1,133	1,314	376	520	1,133	1,314		
Space heating (Average climate)	Energy efficiency class		A+				-					
	Capacity	Pdesign	kW	4.70	7.80	9.52		4.70	7.80	9.52		
	SCOP/A			4.05	4.20	4.15	3.94	4.05	4.20	4.15	3.94	
	ηs,h		%	-	-	163	155	-	-	163	155	
Annual energy consumption		kWh/a	1,625	2,600	3,209	3,383	1,625	2,600	3,209	3,383		
Indoor unit			FVA	71A	100A	125A	140A	71A	100A	125A	140A	
Dimensions	Unit	HeightxWidthxDpeth	mm	1,850x600x270			1,850x600x350		1,850x600x270		1,850x600x350	
Weight	Unit		kg	42		50		42		50		
Air filter	Type			Resin net								
Fan	Air flow rate	Cooling	Low/Medium/High	m³/min	14/16/18	22/25/28	24/26/28	26/28/30	14/16/18	22/25/28	24/26/28	26/28/30
		Heating	Low/Medium/High	m³/min	14/16/18	22/25/28	24/26/28	26/28/30	14/16/18	22/25/28	24/26/28	26/28/30
Sound power level	Cooling		dBA	55	62	63	65	55	62	63	65	
Sound pressure level	Cooling	Low/Medium/High	dBA	38/41/43	44/47/50	46/48/51	48/51/53	38/41/43	44/47/50	46/48/51	48/51/53	
	Heating	Medium/Nom./High	dBA	38/41/43	44/47/50	46/48/51	48/51/53	38/41/43	44/47/50	46/48/51	48/51/53	
Control systems	Wired remote control			BRC1H52W/S/K / BRC1E53A / BRC1E53B / BRC1E53C / BRC1D52								
Power supply	Phase/Frequency/Voltage		Hz/V	1~/50/60/220-240/220								
Outdoor unit			RZAG	71NV1	100NV1	125NV1	140NV1	71NY1	100NY1	125NY1	140NY1	
Dimensions	Unit	HeightxWidthxDpeth	mm	870x1,100x460								
Weight	Unit		kg	81	85	95		81	85	94		
Sound power level	Cooling		dBA	64	66	69	70	64	66	69	70	
	Heating		dBA	-	-	68	71	-	-	68	71	
Sound pressure level	Cooling	Nom.	dBA	46	47	49	50	46	47	49	50	
	Heating	Nom.	dBA	48	50	52		48	50	52		
Operation range	Cooling	Ambient	Min.~Max.	°CDB -20~52								
	Heating	Ambient	Min.~Max.	°CWB -20~18								
Refrigerant	Type/GWP			R-32/675								
	Charge		kg/TCO2Eq	3.20/2.16		3.70/2.50		3.20/2.16		3.70/2.50		
Piping connections	Liquid/Gas OD		mm	9.52/15.9								
	Piping length	OU - IU	Max.	m	55	85		55	85			
		System Equivalent	Chargeless	m	75	100		75	100			
	Additional refrigerant charge		kg/m	See installation manual								
	Level difference IU - OU		Max.	m 30								
Power supply	Phase/Frequency/Voltage		Hz/V	1~/50 /220-240				3~/50 /380-415				
Current - 50Hz	Maximum fuse amps (MFA)		A	20	32		16					

Contains fluorinated greenhouse gases

# Floor standing unit

For commercial spaces with high ceilings

- › Combination with Sky Air Advance-series ensures good value for money for all types of commercial applications
- › Decrease of temperature variation by automatic fan speed selection or freely selectable 3-step fan speed.
- › Improved comfort as a result of better airflow distribution from the vertical out blow which allows manual adjustment of air outlet blades at the top of the unit.
- › Selectable horizontal out blow to better suit the layout of the room (via wired remote controller BRC1E\*/BRC1H\*)

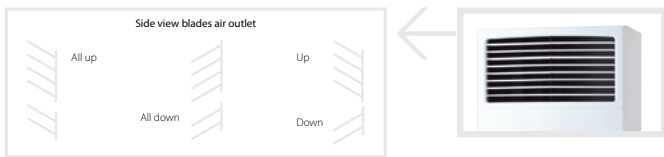

More details and final information can be found by scanning or clicking the QR codes.



FVA-A



RZASG-MV1



RZASG-MY1

Efficiency data		FVA + RZASG	71A + 71MV1	100A + 100MV1	125A + 125MV1	140A + 140MV1	100A + 100MY1	125A + 125MY1	140A + 140MY1		
Cooling capacity	Nom.	kW	6.80	9.50	12.1	13.4	9.50	12.1	13.4		
Heating capacity	Nom.	kW	7.50	10.8	13.5	15.5	10.8	13.5	15.5		
Space cooling	Energy efficiency class		A+			-		A+			
	Capacity	Pdesign	kW	6.80	9.50	12.1	13.4	9.50	12.1		
	SEER			5.83	5.72	5.52	5.63	5.72	5.52		
	ηs,c		%	-	-	218	222	-	218		
Annual energy consumption		kWh/a	408	581	1,314	1,428	581	1,314	1,428		
Space heating (Average climate)	Energy efficiency class		A+		A		-		A		
	Capacity	Pdesign	kW	4.50	6.00	7.80	6.00	7.80	6.00		
	SCOP/A			4.04	3.83	3.64	3.81	3.83	3.64		
	ηs,h		%	-	-	143	149	-	143		
Annual energy consumption		kWh/a	1,559	2,193	2,308	2,866	2,193	2,308	2,866		
Indoor unit		FVA	71A	100A	125A	140A	100A	125A	140A		
Dimensions	Unit	HeightxWidthxDpeth	mm	1,850x600x270		1,850x600x350					
Weight	Unit		kg	42	50						
Air filter	Type		Resin net								
Fan	Air flow rate	Cooling	Low/Medium/High	m³/min	14/16/18	22/25/28	24/26/28	26/28/30	22/25/28	24/26/28	26/28/30
		Heating	Low/Medium/High	m³/min	14/16/18	22/25/28	24/26/28	26/28/30	22/25/28	24/26/28	26/28/30
Sound power level	Cooling		dBA	55	62	63	65	62	63	65	
Sound pressure level	Cooling	Low/Medium/High	dBA	38/41/43	44/47/50	46/48/51	48/51/53	44/47/50	46/48/51	48/51/53	
	Heating	Medium/Nom./High	dBA	38/41/43	44/47/50	46/48/51	48/51/53	44/47/50	46/48/51	48/51/53	
Control systems	Wired remote control		BRC1H52W/S/K / BRC1E53A / BRC1E53B / BRC1E53C / BRC1D52								
Power supply	Phase/Frequency/Voltage		Hz/V	1~/50/60/220-240/220							
Outdoor unit		RZASG	71MV1	100MV1	125MV1	140MV1	100MY1	125MY1	140MY1		
Dimensions	Unit	HeightxWidthxDpeth	mm	770x900x320		990x940x320					
Weight	Unit		kg	60	70	78	70	71	77		
Sound power level	Cooling		dBA	65	70	71	73	70	71		
	Heating		dBA	-	-	71	73	-	71		
Sound pressure level	Cooling	Nom.	dBA	46	53	54	53	54	54		
	Heating	Nom.	dBA	47	-	-	57	-	-		
Operation range	Cooling	Ambient	Min.~Max.	°CDB -15~-46							
	Heating	Ambient	Min.~Max.	°CWB -15~-15.5							
Refrigerant	Type/GWP		R-32/675								
	Charge		kg/TCO2Eq	2.45/1.65	2.60/1.76	2.90/1.96	2.60/1.76	2.90/1.96			
Piping connections	Liquid/Gas OD		mm	9.52/15.9							
	Piping length	OU - IU	Max.	m							
		System	Equivalent	m							
		Chargeless		m							
	Additional refrigerant charge		kg/m								
	Level difference IU - OU	Max.	m								
Power supply	Phase/Frequency/Voltage		Hz/V	1~/50 /220-240			3~/50 /380-415				
Current - 50Hz	Maximum fuse amps (MFA)		A	20	25	32	16				

Contains fluorinated greenhouse gases

# Concealed floor standing unit

Designed to be concealed in walls

- › Combination with Sky Air Alpha-series ensures best in class quality, highest efficiency and performance
- › Discretely concealed in the wall: only the suction and discharge grilles are visible
- › Requires very little installation space as the depth is only 200mm
- › Its low height (620 mm) enables the unit to fit perfectly beneath a window
- › High ESP allows flexible installation



More details and final information can be found by scanning or clicking the QR codes.



FNA-A9



RZAG-A

Efficiency data		FNA + RZAG		35A9 + 35A		50A9 + 50A		60A9 + 60A		
Cooling capacity	Min./Nom./Max.	kW		1.6/3.5/4.5		1.7/5.0/6.0		1.7/6.0/6.5		
Heating capacity	Min./Nom./Max.	kW		1.40/4.00/5.00		1.70/5.00/6.00		1.70/7.00/7.50		
Space cooling	Energy efficiency class					A+				
	Capacity	Pdesign	kW	3.50		5.00		6.00		
	SEER			5.90				5.70		
Annual energy consumption			kWh/a		208		297		368	
Space heating (Average climate)	Energy efficiency class					A				
	Capacity	Pdesign	kW	3.50		4.30		4.50		
	SCOP/A					3.90				
	Annual energy consumption			kWh/a		1,255		1,542		1,616
Indoor unit		FNA		35A9		50A9		60A9		
Dimensions	Unit	HeightxWidthxDepth	mm	620/720x790x200		620/720x1,190x200				
Weight	Unit		kg	23.0		30.0				
Air filter	Type		Resin net							
Fan	Air flow rate	Cooling	Low/High	m <sup>3</sup> /min	7.3/8.7		13.5/16.0			
		Heating	Low/High	m <sup>3</sup> /min	7.3/8.7		13.5/16.0			
	External static pressure			Nom./High	Pa	30/48		40/49		
Sound power level	Cooling			dB(A)	53.0		56.0			
Sound pressure level	Cooling	Low/Medium/High		dB(A)	28.0/31.0/33.0		30.0/33.0/36.0			
	Heating	Low/Nom./High		dB(A)	28.0/31.0/33.0		30.0/33.0/36.0			
Control systems	Infrared remote control			BRC4C65						
	Wired remote control			BRC1H52W/S/K / BRC1E53A / BRC1E53B / BRC1E53C / BRC1D52						
Power supply	Phase/Frequency/Voltage		Hz/V	1~/50/60/220-240/220						
Outdoor unit		RZAG		35A		50A		60A		
Dimensions	Unit	HeightxWidthxDepth	mm			734x870x373				
Weight	Unit		kg			52				
Sound power level	Cooling		dB(A)	62.0		63.0		64.0		
	Heating		dB(A)	62.0		63.0		64.0		
Sound pressure level	Cooling	Nom.	dB(A)	48.0		49.0		50.0		
	Heating	Nom.	dB(A)	48.0		49.0		50.0		
Operation range	Cooling	Ambient	Min.~Max.	°CDB			-20~-52			
	Heating	Ambient	Min.~Max.	°CWB			-20~-24			
Refrigerant	Type/GWP			R-32/675.0						
	Charge			kg/TCO <sub>2</sub> Eq			1.55/1.05			
Piping connections	Liquid/Gas OD		mm	6.35/9.50		6.35/12.7				
	Piping length	OU - IU	Max.	m			50			
	System Chargeless			m			30			
	Additional refrigerant charge			kg/m			0.02 (for piping length exceeding 30m)			
Power supply	Level difference IU - OU		Max.	m			30.0			
	Phase/Frequency/Voltage		Hz/V	1~/50 / 220-240						

Contains fluorinated greenhouse gases

# Concealed floor standing unit

Designed to be concealed in walls

- › Combination with split outdoor units is ideal for small retail, offices and residential applications
- › Discretely concealed in the wall: only the suction and discharge grilles are visible
- › Requires very little installation space as the depth is only 200mm
- › Its low height (620 mm) enables the unit to fit perfectly beneath a window
- › High ESP allows flexible installation



More details and final information can be found by scanning or clicking the QR codes.



FNA-A9



RXM-R



RXM-R9

Efficiency data		FNA + RXM		25A9 + 25R9		35A9 + 35R9		50A9 + 50R		60A9 + 60R	
Cooling capacity	Nom.	kW		2.60		3.40		5.00		6.00	
Heating capacity	Nom.	kW		3.20		4.00		5.80		7.00	
Space cooling	Energy efficiency class					A+				A	
	Capacity	Pdesign	kW	2.60		3.40		5.00		6.00	
	SEER			5.68		5.70		5.77		5.56	
	Annual energy consumption			kWh/a		160		209		303	
Space heating (Average climate)	Energy efficiency class							A+			
	Capacity	Pdesign	kW	2.80		2.90		4.00		4.60	
	SCOP/A			4.24		4.05		4.09		4.16	
	Annual energy consumption			kWh/a		924		1,002		1,368	
Indoor unit		FNA		25A9		35A9		50A9		60A9	
Dimensions	Unit	HeightxWidthxDPTH		mm		620 (1) / 720 x790 x200		620 (1) / 720 x1,190 x200			
Weight	Unit	kg		23.0				30.0			
Air filter	Type	Resin net									
Fan	Air flow rate	Cooling	Low/High	m <sup>3</sup> /min	7.3 / 8.7				13.5 / 16.0		
		Heating	Low/High	m <sup>3</sup> /min	7.3 / 8.7				13.5 / 16.0		
	External static pressure	Nom./High		Pa	30 / 48				40 / 49		
Sound power level	Cooling	dBA		53.0				56.0			
Sound pressure level	Cooling	Low/Medium/High		dBA	28.0 / 31.0 / 33.0				30.0 / 33.0 / 36.0		
	Heating	Low/Nom./High		dBA	28.0 / 31.0 / 33.0				30.0 / 33.0 / 36.0		
Control systems	Infrared remote control							BRC4C65			
	Wired remote control							BRC1H52W/S/K / BRC1E53A / BRC1E53B / BRC1E53C / BRC1D52			
Power supply	Phase/Frequency/Voltage			Hz/V			1~/50/60/220-240/220				
Outdoor unit		RXM		25R9		35R9		50R		60R	
Dimensions	Unit	HeightxWidthxDPTH		mm		552 x840 x350		734 x954 x401			
Weight	Unit	kg		32				49.0			
Sound pressure level	Cooling	Nom.		dBA	46.0		49.0		48.0		
	Heating	Nom.		dBA	47.0				49.0		
Operation range	Cooling	Ambient	Min.~Max.	°CDB	-10 ~50 / 46				-10 ~50 / 46		
Refrigerant	Type							R-32			
	GWP			675				675.0			
	Charge			kg/TCO2Eq		0.76 / 0.52		1.15 / 0.780			
Piping connections	Liquid	OD		mm	6.35		6		12.7		
	Gas	OD		mm	9.50		10		12.7		
	Piping length	OU - IU	Max.	m	20		10		30		
		System	Chargeless	m							
	Additional refrigerant charge			kg/m		0.02 (for piping length exceeding 10m)					
Power supply	Phase/Frequency/Voltage			Hz/V			1~/50 / 220-240				
Current - 50Hz	Maximum fuse amps (MFA)			A	13				16		

(1)Including installation legs | Contains fluorinated greenhouse gases



SKY AIR ALPHA-SERIES - LOW HEIGHT UNIT



LOW SOUND ENCLOSURE FOR SKY AIR ALPHA-SERIES (RZAG-N) AND ADVANCE-SERIES (RZA-D)



# Outdoor units

A range of industry leading technology outdoor units

Products overview outdoor units	58
Benefits overview outdoor units	59
<b>SkyAir</b> <i>A-series</i>	59
Low sound enclosure	60
Replacement technology	66
Variable Refrigerant Temperature	68
<b>R-32</b> BLUEEVOLUTION range	78
RZAG-A <b>SkyAir</b> <i>Alpha-series</i>	78
RZAG-NV1/NY1 <b>SkyAir</b> <i>Alpha-series</i>	78
RZASG-MV1/MY1 <b>SkyAir</b> <i>Advance-series</i>	79
RZA-D <b>SkyAir</b> <i>Advance-series</i>	80
ARXM-R/AZAS-MV1/MY1 <b>SkyAir</b> <i>Active-series</i>	81
Rooftop	82
Why choose Daikin Rooftop series	82
UATYA-BBAY1	84
UATYA-BFC2Y1	84
UATYA-BFC3Y1	85
UATYA-BRS4	85

Pair solution

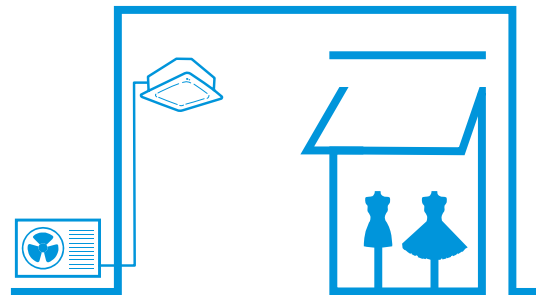

Twin, triple, double twin solution

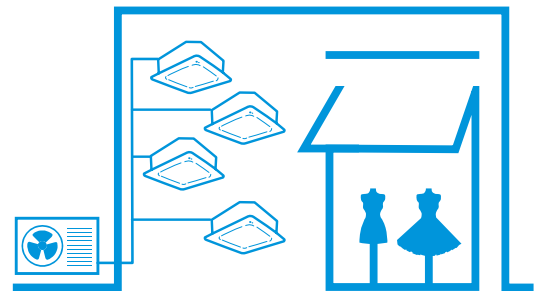

Multi solution

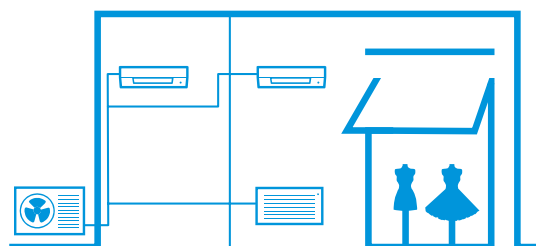

# Products overview outdoor units



BLUEEVOLUTION

**R-32** SkyAir A-series

Pair, twin, triple & double twin application

System	Type	Model	Product name	35	50	60	71	100	125	140	200	250	
Air cooled	Heat pump	<p><b>SkyAir Alpha-series</b></p> <ul style="list-style-type: none"> <li>- Industry leading technology for commercial applications</li> <li>- Dedicated solution for infrastructure cooling</li> <li>- Variable Refrigerant Temperature (RZAG71-100-125-140 series)</li> <li>- Maximum piping length up to 85m (50m for RZAG35-50-60)</li> <li>- Replacement technology</li> <li>- Extended operation range down to -20°C in both heating and cooling</li> <li>- Pair, twin, triple and double twin application (RZAG71-100-125-140 series)</li> </ul>	<p><b>R-32</b></p> <p><b>A++</b></p> <p>(A+++ - D)</p>										
			<p><b>RZAG-A</b></p> <p><b>RZAG-NV1/NY1</b></p>										
		<p><b>SkyAir Advance-series</b></p> <ul style="list-style-type: none"> <li>- Technology and comfort combined for commercial applications</li> <li>- Very compact and easy to install outdoor units</li> <li>- Maximum piping length up to 50m (RZA-D up to 100m)</li> <li>- Replacement technology</li> <li>- Operation range down to -15°C both cooling and in heating (RZA-D down to -20°C)</li> <li>- Pair, twin, triple and double twin application</li> </ul>	<p><b>R-32</b></p> <p><b>A+</b></p> <p>(A+++ - D)</p>										
		<p><b>RZASG-MV1/MY1</b></p>											
		<p><b>RZA-D</b></p>											
		<p><b>SkyAir Active-series</b></p> <ul style="list-style-type: none"> <li>- Ideal solution for busy environments and small shops</li> <li>- Very compact and easy to install outdoor units</li> <li>- Maximum piping length up to 30m</li> <li>- Replacement technology</li> <li>- Easy-to-mount outdoor units: roof, terrace or wall</li> <li>- Exclusively offered for pair applications</li> </ul>	<p><b>R-32</b></p> <p><b>A</b></p> <p>(A+++ - D)</p>										
		<p><b>ARXM-R</b></p> <p><b>AZAS-MV1/MY1</b></p>											

# Benefits overview outdoor units

		<i>SkyAir Alpha-series</i>		<i>SkyAir Advance-series</i>		<i>SkyAir Active-series</i>
		RZAG-A	RZAG-NV1/NY1	RZASG-MV1/MY1	RZA-D	AZAS-MV1/MY1
We care icons	Seasonal efficiency - Smart use of energy	 (A+++ - D)	 (A+++ - D)	 (A+++ - D)	-	 (A+++ - D)
	Inverter technology	●	●	●	●	●
	Replacement technology	●	●	●	●	●
Comfort	Night quiet	●	●	●	●	●
	Auto cooling-heating changeover	●	●	●	●	●
Other functions	Variable refrigeration temperature		●			
	Twin/triple/double twin application		●	●	●	
	Swing compressor	●	●	●	●	●
	Guaranteed operation down to -20°C	●	●		●	
	Infrastructure cooling	●	●			
	Low sound enclosure		○		○	

## Technical benefit overview

## SkyAir A-series

	<i>SkyAir Alpha-series</i>		<i>SkyAir Advance-series</i>		<i>SkyAir Active-series</i>
	RZAG-A	RZAG-NV1/NY1	RZASG-MV1/MY1	RZA-D	AZAS-MV1/MY1
Compact single fan casing on the entire range	●	●	●	●	●
Maximum piping length	50m	85m	50 m	100 m	30 m
Pivoting front plate		●	●	●	●
7 segment display		●	●	●	●
Increased factory charge	●	●			
Integrated leak check		●			
Refrigerant bottom plate pass		●			
Specially developed R-32 swing compressor	●	●	●	●	●
Refrigerant cooled PCB		●	●	●	●
Intelligent Tablet controller - Onecta app	○	○	○	○	○

● standard, ○ optional

# Low sound enclosure

EKLN140A



-10 dB(A)!

Meet strict sound requirements, while increasing flexibility to apply Sky Air and VRV systems thanks to **sound power reduction of up to 10 dB(A)**

- ✓ Specially designed for Sky Air and VRV heat pumps
- ✓ Factory tested and guaranteed data for capacity, efficiency and sound (according to ISO 3744)
- ✓ Minimal capacity reduction
- ✓ No additional calculations needed thanks to factory tested data, reducing design workload

## Tried and tested: values that you can rely on

You want to finish your work faster? You want reliable results? You want your customers to get exactly what they ordered?

Our low sound enclosure eliminates possible problems and reduces your workload significantly:

- › **No incompatibilities** – tested combinations with the outdoor unit that you want to encase
- › **No surprises** – measured and guaranteed sound reduction according to ISO 3744
- › **No calculations** – tested performance values for capacity and efficiency



Sound power level measurement in acoustic chamber



Sound enclosure			EKLN140A	
Casing	Colour		Anthracite (RAL 7016)	
	Material		Sheet metal	
Dimensions	Unit	Height	mm	1,100
		Width	mm	1,400
		Depth	mm	1,500
	Packed unit	Height	mm	1,017
		Width	mm	1,517
		Depth	mm	917
Weight	Unit	kg	152	
	Packed unit	kg	186	
Combines with	Sky Air Alpha-series		RZAG-NV1/NY1	
	Sky Air Advance-series		RZA-D	
	VRV 5 S-series		RXYS-AV1/AY1	

## Benefits

- ✓ **Dedicated Daikin option for:**
  - › Sky Air Alpha-series
  - › Sky Air Advance-series
  - › VRV 5 S-series
- ✓ **Fully optimised and tested in Daikin factory**
  - › Guaranteed performance levels (sound, capacity, efficiency)
- ✓ **Outdoor unit sound reduction of up to -10 dB(A) on sound power levels**
  - › Enabling to meet local sound requirements
  - › Increased flexibility to apply outdoor units
  - › Reduces sound on the entire sound spectrum
- ✓ **Minimal capacity reduction**
  - › Separated air intake and discharge to prevent air flow short circuit
  - › No additional calculations needed thanks to factory tested data
- ✓ **Easy to integrate**
  - › Anthracite (RAL 7016), highly aesthetic finishing
  - › Mechanically designed to perfectly suit the Sky Air Alpha/Advance and VRV 5 S-series casings
  - › Self-supporting; can be installed on any flat surface
- ✓ **Fast & easy installation & servicing**
  - › 100 % weather resistant
  - › Easy opening to access most system components
- ✓ **Durable**
  - › 3 years warranty on all components
  - › Made of stainless steel with robust double layer powder coating, ensuring maximum corrosion resistance

### Increased flexibility to apply heat pumps based on tested data

The reduction of the sound power levels (up to -10 dB(A)) across the entire sound spectrum increases your flexibility significantly. In the example below with the low sound enclosure, the heat pump can be installed as close as 5.5 m to the next premises, based on the 32 dB(A) threshold (check local regulations). Thanks to the precise Daikin sound and capacity data you can be confident about the solution you are offering.

Without Daikin sound enclosure **you need to maintain a 15 m distance** from your closest neighbour

With the Daikin sound enclosure **you can install as close as 5.5 m** from your closest neighbour

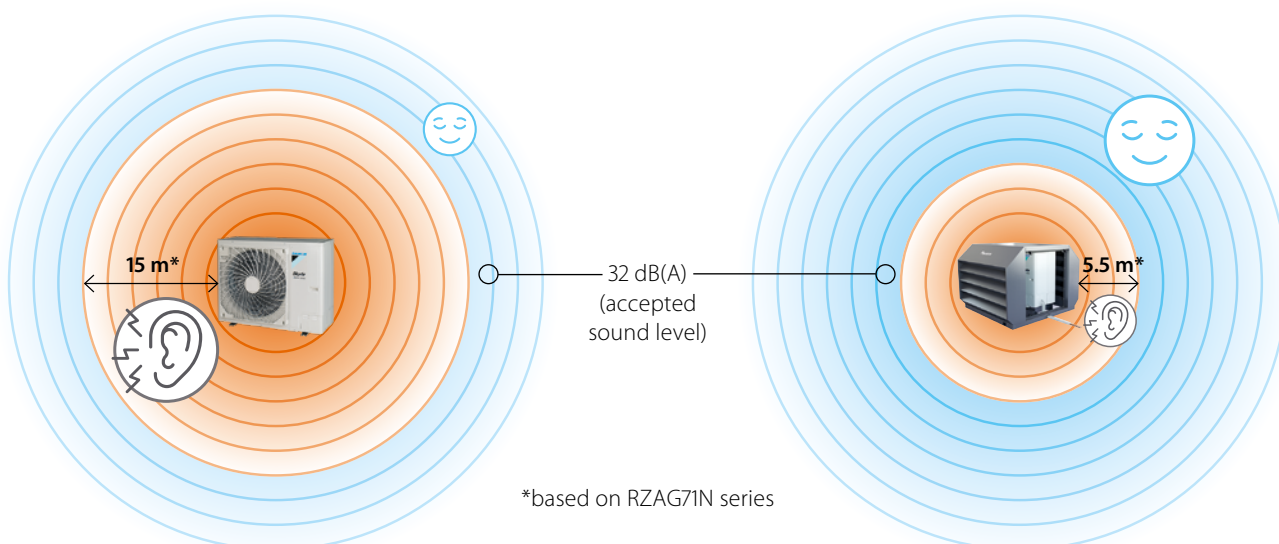

# Tested to ease your work!

Double win with Daikin

## Validated data

The sound enclosure is extensively tested with all suitable outdoor units. We offer measured data for:

- › Sound power (heating/cooling) according to ISO 3744
- › Sound pressure (heating/cooling) at 1 m distance
- › Sound pressure for low noise operation
- › Sound enclosure insertion loss
- › All data delivered in octave band spectra and A-weighted sound level

More details and final information can be found by scanning or clicking the QR codes.



EKLN-A



## Sound power reduction values

Range	Outdoor unit name	Cooling sound power		Heating sound power	
		Sound reduction	Nominal sound with sound enclosure	Sound reduction	Nominal sound with sound enclosure
Sky Air Alpha-series	RZAG71NV1/NY1	-9 dB(A)	55	-7 dB(A)	57
	RZAG100NV1/NY1	-8 dB(A)	58	-8 dB(A)	60
	RZAG125NV1/NY1	-10 dB(A)	59	-10 dB(A)	59
	RZAG140NV1/NY1	-9 dB(A)	61	-9 dB(A)	62
Sky Air Advance-series	RZA200D	-7 dB(A)	66	-5 dB(A)	72
	RZA250D	-6 dB(A)	70	-5 dB(A)	75
VRV 5 S-series	RXYS44AV1/AY1	-7 dB(A)	60	-7 dB(A)	61
	RXYS45AV1/AY1	-8 dB(A)	60	-9 dB(A)	60
	RXYS46AV1/AY1	-8 dB(A)	61	-9 dB(A)	61

## Efficiency and capacity impact

Range & outdoor unit name	Outdoor unit only		With sound enclosure		Outdoor unit only		With sound enclosure		Outdoor unit only		With sound enclosure		Correction factor maximum capacity	
	SEER/η s,c	SCOP/η s,h	SEER/η s,c	SCOP/η s,h	SEER/η s,c	SCOP/η s,h	SEER/η s,c	SCOP/η s,h	SEER/η s,c	SCOP/η s,h	SEER/η s,c	SCOP/η s,h	Cooling	Heating
Sky Air Alpha-series	+ FCAHG71/100/125/140A				+ FCAG71/100/125/140B				+ FBA71/100/125/140A					
RZAG71NV1/NY1	7.90/-	4.56/-	6.72/-	4.10/-	6.83/-	4.22/-	5.81/-	3.80/-	6.50/-	4.20/-	5.53/-	3.78/-	85 %	90 %
RZAG100NV1/NY1	7.70/-	4.75/-	6.62/-	4.44/-	7.14/-	4.53/-	6.07/-	4.14/-	6.47/-	4.36/-	5.50/-	4.01/-	86 %	
RZAG125NV1/NY1	8.02/318	4.53/178	6.96/275	4.26/167	7.14/283	4.34/171	6.26/247	4.15/163	6.56/259	4.37/172	5.92/234	4.12/162	90 %	
RZAG140NV1/NY1	7.93/314	4.44/175	6.84/271	4.21/165	6.80/269	4.34/171	5.83/230	4.17/164	6.42/254	4.34/171	5.62/222	4.14/162		
Sky Air Advance-series	+ FDA200/250A				+ 4 x FCAG50/60B				+ 4 x FBA50/60A					
RZA200D	6.26/247	3.59/141	5.90/233	3.17/124	7.16/283	4.10/161	6.52/258	3.56/140	6.51/257	4.20/165	5.90/233	3.65/143	84 %	80 %
RZA250D	5.38/212	3.55/139	4.91/193	3.14/123	6.95/275	4.10/161	6.18/244	3.56/139	6.69/264	4.33/170	5.95/235	3.78/148		
VRV 5 S-series	+ FXSA**													
RXYS44AV1	8.2/324	5.1/200	7.2/284	4.9/193										95 %
RXYS44AY1	7.9/312	4.9/193	6.9/273	4.7/186										
RXYS45AV1	7.7/306	4.7/186	6.7/264	4.5/178										
RXYS45AY1	7.4/295	4.5/179	6.4/254	4.4/172										
RXYS46AV1	7.6/301	4.7/184	6.5/257	4.5/176										
RXYS46AY1	7.3/290	4.5/177	6.3/248	4.3/170										

\*\*4 HP: + 3 x FXSA25A + 1 x FXSA32A    5 HP: + 4 x FXSA32A    6 HP: + 2 x FXSA32A + 2 x FXSA40A

## Sound power levels – cooling and heating, according to ISO 3744

- > dB(A) = A-weighted sound power level (A scale according to IEC)
- > Reference acoustic intensity: 0 dB =  $\cdot 10^{-12}$  W.

■ RZAG125N  
■ RZAG125N + EKLN140A

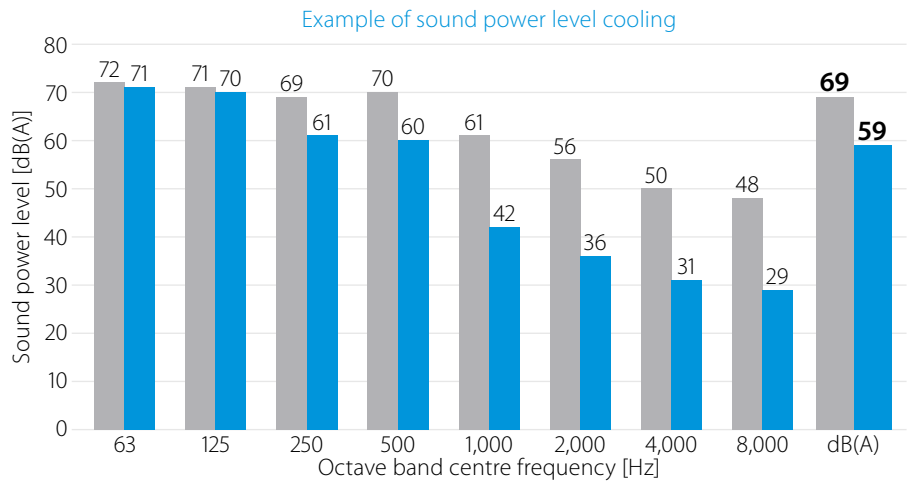

## Sound pressure levels – cooling and heating

- > Data is valid at free field condition
- > Data is valid at nominal operation conditions
- > dB(A) = A-weighted sound pressure level (A scale according to IEC)
- > Reference acoustic pressure 0 dB = 20  $\mu$ Pa
- > Microphone location at the discharge side; 1 m from the object; 1.5 m above the ground

■ RZAG125N  
■ RZAG125N + EKLN140A

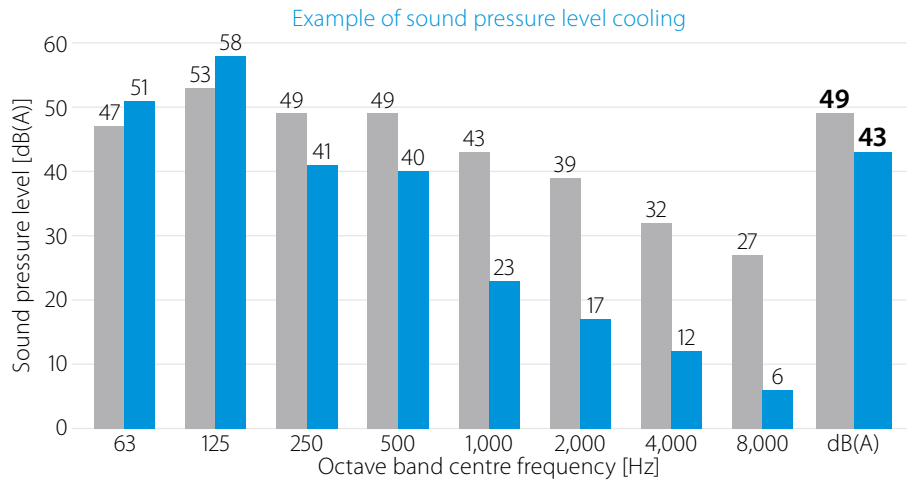

## Sound pressure levels – low noise operation (level 3)

- > Data is valid at free field condition
- > Data is valid at nominal operation conditions
- > dB(A) = A-weighted sound pressure level (A scale according to IEC)
- > Reference acoustic pressure 0 dB = 20  $\mu$ Pa
- > Microphone location at the discharge side; 1 m from the object; 1.5 m above the ground

■ RZAG125N  
■ RZAG125N + EKLN140A

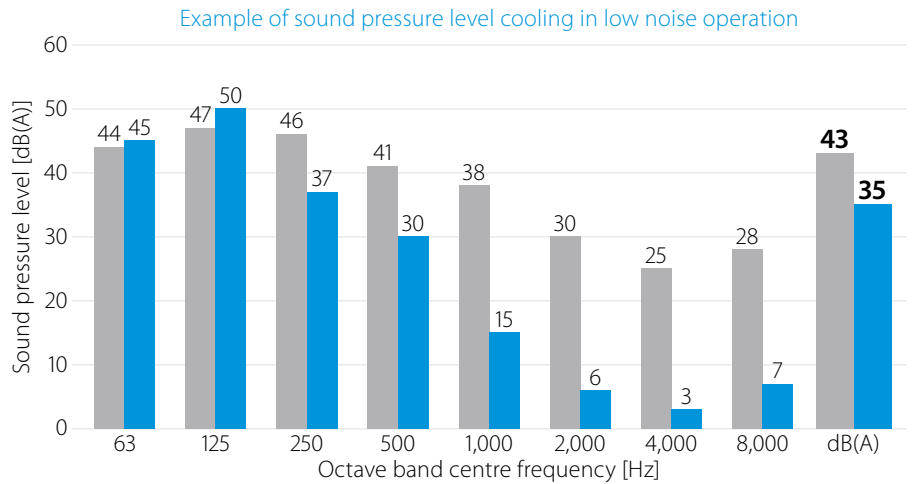

## Insertion loss values

- > Insertion loss measurement of standalone enclosure with calibrated sound source

■ Sound power level [dB(A)]  
■ Reference sound source (RSS): B&K Type 4204 RSS

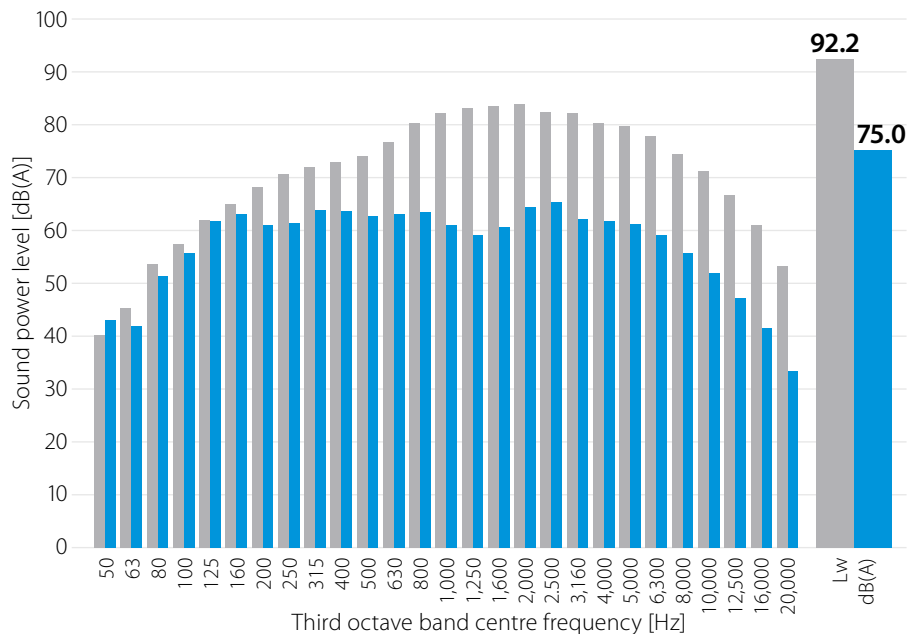
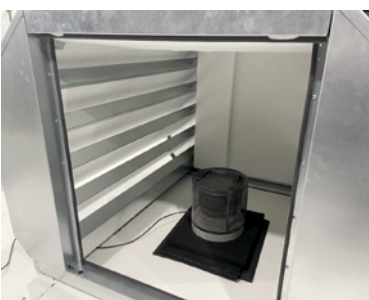

**SkyAir** *Advance-series*

**SkyAir** *Alpha-series*

Low height.  
High value.



- ✓ Unique, low-height single fan range

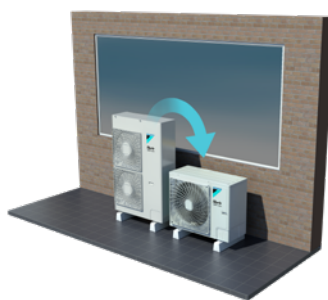

**SkyAir Alpha-series**  
RZAG71-100-125-140NV1/NY1



**SkyAir Advance-series**  
RZA200-250D

- ✓ Compact unit, easy to transport

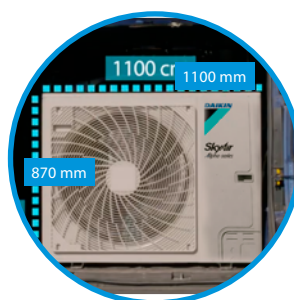

- ✓ Market-leading serviceability and handling



Fast and easy access to all critical component

- › Single screw access
- › Wider access area

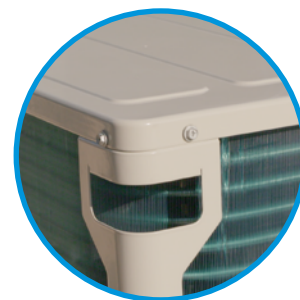

Newly positioned handle for easier carrying



**✓** Very long piping length

- › Up to 85m for RZAG-NV1/NY1
- › Up to 100m for RZA-D

**✓** Wide operation range down to -20°C

- › Cooling operation from -20°C up to +52°C (+46°C for RZA-D)
- › Heating operation down to -20°C

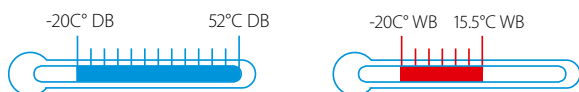

**✓** Faster installation with up to 40m pre-charged pipe

- › Up to 60% of applications can be installed without additional refrigerant charge
- › 40m pre-charge for RZAG-NV1/NY1
- › 30m pre-charge for RZA-D

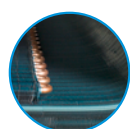

3-row heat exchanger

- › Unique 3-row heat exchanger to allow compact casing up to 14kW



Bottom plate and heat exchanger refrigerant pass

- › Drain holes are kept ice free
- › Guaranteed operation down to -20°C

Swing compressor optimised for seasonal efficiency



New and bigger fan design

- › Ensures high air volume with low air velocity
- › Reduces sound emissions



New 7-segment display to view errors and systems settings

Refrigerant cooled PCB

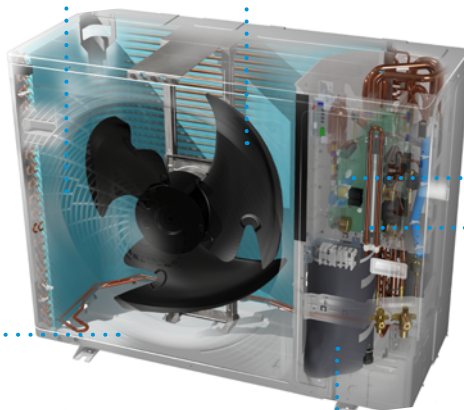

# Replacement technology

The quick and quality way of upgrading R-22 and R-410A systems

## Benefits to increase your profit Optimise your business

### Less installation time

Tackle more projects in less time thanks to faster installation. It is more profitable than replacing the full system with new piping.

### Lower installation costs

Reducing installation costs enables you to offer customers the most cost-effective solution and improve your competitive edge.

### Replace non-Daikin systems



It is a trouble-free replacement solution for Daikin systems and for systems made by other manufacturers.

### Easy as one-two-three

A simple solution for replacement technology enables you to handle more projects for more customers in less time and offer them the best price! Everybody gains.

## The benefits will convince your customer

- ✓ To prevent unexpected breakdown
- ✓ To lower running costs
- ✓ To protect the environment
- ✓ To improve comfort

### Your copper pipes will last for multiple generations

Copper pipes used in air conditioning systems tested by Daikin will last over 60 years after installation.

## How does it work?

### The Daikin low-cost upgrade solution

#### ! Replace indoor units

Contact your local dealer to check compatibility in case you need to keep the indoor units.

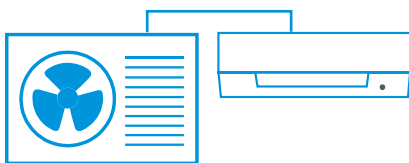

#### ✓ Replace outdoor units

Learn more about Daikin replacement solutions at [www.daikin.eu/en\\_us/knowledge-center/replacement-technology.html](http://www.daikin.eu/en_us/knowledge-center/replacement-technology.html)



## Unique technologies

> Cleaning free piping re-usage thanks to unique hepta filtering for maximum particle reduction

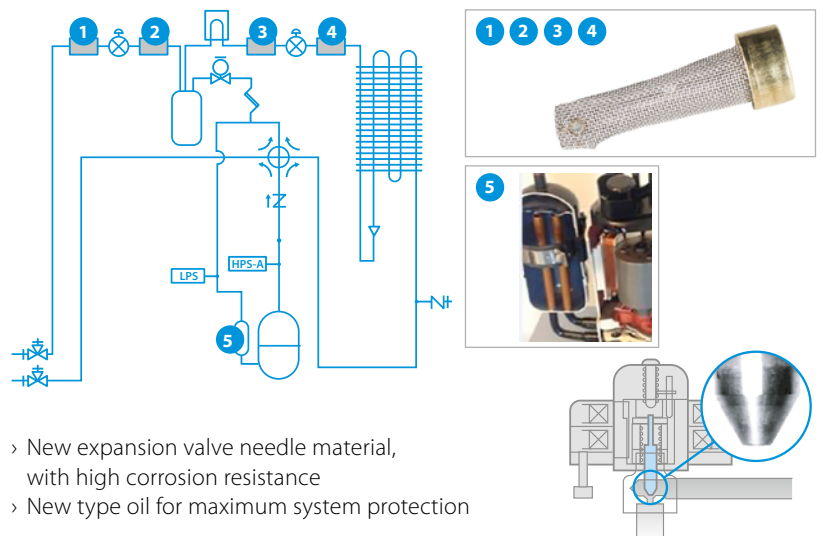

- > New expansion valve needle material, with high corrosion resistance
- > New type oil for maximum system protection

# New simplified replacement procedure with Sky Air A-series outdoor units

**R-32**

How does it work?

## 1 Evaluate if the pipe work can be re-used

- Check if the piping installation is according to standards, that there no fractures or damages and that liquid and gas pipe have separate insulation
- Verify pipe thickness

Outside diameter (mm)	Material	Thickness (mm)
6.4	o	0.8
9.5	o	0.8
12.7	o	0.8
15.9	o	1.0
19.1	1/2H	1.0

o: annealed - 1/2H: half hard

- Verify piping diameter

Sky Air	Liquid	6.4			9.5					12.7				
		Gas	9.5	12.7	15.9	12.7	15.9	19.1	22.2	25.4	15.9	19.1	22.2	25.4
	3.5kW	✓	x	x	x	x	x	x	x	x	x	x	x	x
	5.0kW	Δ	✓	o	Δ	Δ	x	x	x	x	x	x	x	x
	6.0kW	Δ	✓	o	Δ	Δ	x	x	x	Δ	x	x	x	x
	7.1kW	x	Δ	Δ	x	✓	x	x	x	Δ	x	x	x	x
	10.0-14.0kW	x	x	Δ	x	✓	o	x	x	Δ	Δ	x	x	x
	20.0-25.0kW	x	x	x	x	x	x	✓	o	x	x	Δ	Δ	Δ

✓ Possible (Standard condition)

o Possible (With no impact on chargeless length and total length)

Δ Possible (With impact on chargeless length and total length)

x Impossible

- Verify the piping length

	Liquid pipe (mm)	35	50	60	71	100	125-140	200-250
Chargeless (equivalent)	6.4	30 (40) m	30 (40) m	30 (40) m		10 / (15) m		N/A
	9.5	-	15 (20) m	15 (20) m		40 / (50) m		N/A
	12.7	-	-	10 (15) m		15 / (20) m		N/A
Max. total length (equivalent)	6.4	50 (65) m	50 (65) m	50 (65) m		10 / (15) m		N/A
	9.5	-	25 (35) m	25 (35) m	55 / (75) m	85 / (100) m		100 m
	12.7	-	-	10 (15) m	25 / (35) m	35 / (45) m		50 m

- Check if any operation history affects the ability to re-use the pipes(systems with a pipe length up to 35m, can always re-use existing pipe work when using a new Sky Air A-series model)

System to be replaced	System condition	Piping length	R-32 Sky Air A-series
R-22 (mineral oil)	Unit is operating (pump down can be performed)	No restrictions	✓
	Pump down operation impossibility or compressor malfunction	Below 35 m	✓
		Above 35 m	o
R-410A (synthetic oil)	Unit is operating (pump down can be performed)	No restrictions	✓
	Pump down operation impossibility or compressor malfunction	Below 35 m	✓
		Above 35 m	o
R-32 (synthetic oil)	Unit is operating (pump down can be performed)	No restrictions	✓
	Pump down operation impossibility or compressor malfunction	Below 35 m	✓
		Above 35 m	o

✓ **Cleaning-free** piping re-use

o Cleaning of field piping or replacement of field piping is required

- The Flare connection **MUST** be redone by using the flare nut included with the new outdoor unit

## 2 Evaluate if the wiring can be re-used

- Check if the wiring meets current standard and the specification of the new unit and that there is no damage or scratches

# Variable Refrigerant Temperature

## The ultimate customer experience



- ✓ Increases air discharge temperature and eliminates cold drafts!
- ✓ Increased customer comfort and reduced energy consumption!

› The system automatically increases its evaporating temperature ( $T_e$ ) when the gap between the actual indoor temperature ( $T_{in}$ ) and the setpoint ( $T_{set}$ ) is becoming smaller, increasing comfort and providing more stable operation

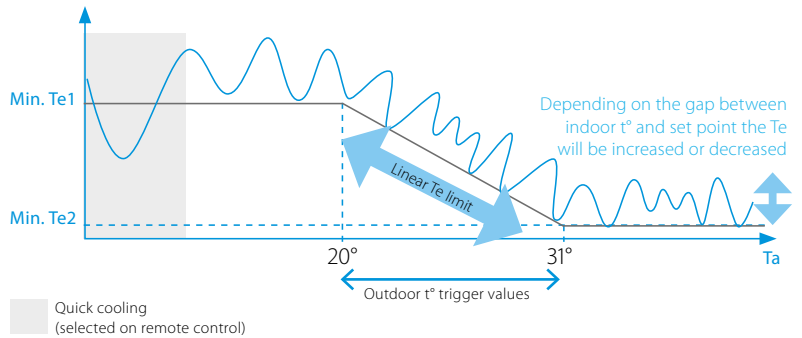

## Case study: JBC, Vilvoorde

- ✓ Two pair systems are installed in the same zone allowing comparison
- ✓ More energy efficient: up to 20% lower energy consumption

Average energy consumption over 5 months of operation

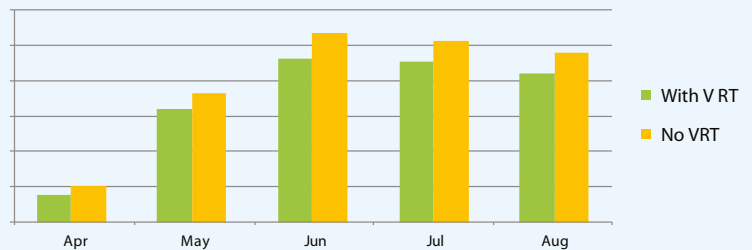

- ✓ Improved comfort: higher discharge temperatures

- › More stable and continuous operation
- › Average discharge temperature increased with 3~4°C

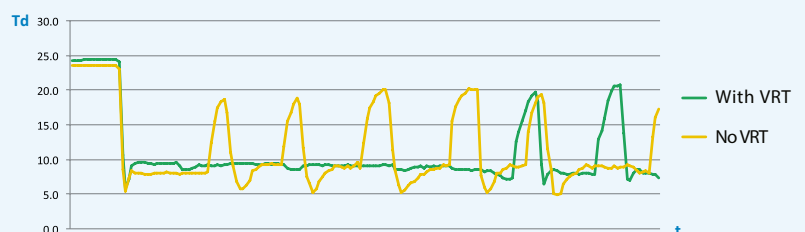



Daikin is the world leader when it comes to cooling. With over 90 years of innovation and engineering expertise in specialised cooling, Daikin offers a Sky Air solution that is **reliable**, **efficient** and **flexible** to meet the demanding needs of infrastructure cooling environments.



**RELIABLE**

- Guaranteed system operation:
- › Oversized indoor units boost cooling capacity and prevent freeze-ups on the indoor side
  - › Wide operating range envelope: operation range in cooling down to -20°C and up to +52°C

**EFFICIENT**

- Optimum return on investment:
- › Lowers running costs by using highly efficient direct expansion cooling systems
  - › Lower running costs compared to other DX systems and water based chillers.
  - › Reduces mechanical cooling and energy consumption with the free cooling option for single phase systems

**FLEXIBLE**

- › Scalable in capacity
- › Improved infrastructure control and management
- › Lower physical footprint since no floor space is occupied
- › Wide range of indoor units to suit application preferences

**UNIQUE**

Dedicated system combinations

**Benefits**

1. Boost the heat transfer capacity of the indoor system
2. Ability to work with higher evaporation temperatures (Te) avoids downtime and enables continuous operation
3. Official energy labels for indoor and outdoor system combinations provide standardized and reliable performance data

**UNIQUE**

2-step solution for system selection

**Benefits**

1. Daikin makes the system selection procedure easy and reliable by providing detailed capacity tables based on extensive testing.
2. Choose the best product combination that meets end-user requirements

**UNIQUE**

Efficient cooling

**Benefits**

1. Free cooling: optimum energy efficiency using cold ambient air
2. Widest range of indoor systems with best in class energy efficiency
3. Wide indoor and outdoor operation range, reliable performance even in extreme conditions

**UNIQUE**

Flexible control

**Benefits**

1. Optimal backup supported by duty rotation control, automatic backup activation and remote alarms
2. Guaranteed continuous operation from extended compressor limits
3. Controller settings to adapt to specific infrastructure cooling environment conditions
4. Fewer start/stop cycles



Click or scan the code to access all technical information



Find out more in our infrastructure cooling brochure

# Boosted capacity indoor systems

## High reliability at lower running costs for infrastructure cooling

Split air conditioning systems for normal comfort cooling applications usually combine indoor systems with matching capacities, or multiple indoor systems with capacities lower than the outdoor system's capacity. This works because the indoor system's cooling capacity is sufficient to handle the higher humidity conditions and varying indoor temperature requirements that are common in a normal living environment.

**Applying this design logic to infrastructure cooling environments can lead to risky situations that might compromise overall system reliability and frequent downtimes of 15 minutes.**

**Indoor systems for infrastructure cooling environments need enhanced capabilities for continuous heat transfer because they work harder to extract energy by cooling dry air. Daikin recommends and offers asymmetric combinations** (boosted capacity indoor combinations: e.g. 71 class outdoor + 100 class indoor).

You can now confidently combine indoor systems with higher capacities than the outdoor system. This will boost heat transfer inside the technology or server room environments.

## Infrastructure cooling application system solutions

### TRADITIONAL SOLUTION

Symmetric indoor-outdoor system combination

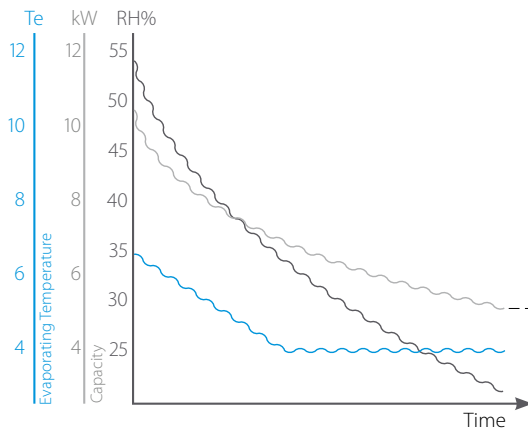

### DEDICATED SOLUTION

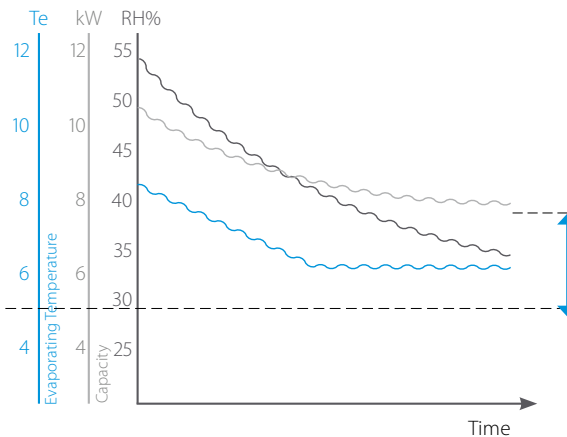

### Improved solution

- 👍 Boosted capacity indoors increase the heat transfer capacity at low relative humidity
- 👍 Allows the system to operate with higher Te, guaranteeing continuous operation and reducing unwanted dehumidification

Between **20-40%** sensible capacity increase

Up to **18%** savings on running cost

## Low humidity + Low ambient environment

Outside temperature Ta	-5 °C
Set-point	22 °C
Humidity	35 %
Indoor wet-bulb temperature	13 °C

### EER

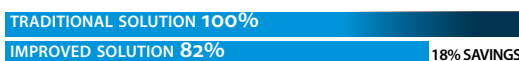

### traditional solution

RZAG71 + <b>FAA71</b>	
Total Capacity (TC)	5.63 kW
Sensible Heat Capacity (SHC)	4.28 kW
Power Input (PI)	2 kW
Co-efficient of Power Input (CPI)	0.39
Corrected PI	0.78 kW
EER*	5.5

### dedicated system combination solution

RZAG71 + <b>FAA100</b>	
<b>Total Capacity (TC)</b>	<b>6.02 kW</b>
<b>Sensible Heat Capacity (SHC)</b>	<b>6.02 kW</b>
<b>Power Input (PI)</b>	<b>1.72 kW</b>
<b>Co-efficient of Power Input (CPI)</b>	<b>0.45</b>
<b>Corrected PI</b>	<b>0.77 kW</b>
<b>EER*</b>	<b>7.82</b>

Sensible Heat Capacity increases **20-40%** with dedicated system combination.

\*EER = (SHC/Corrected PI)

# 2-Step solution for system selection

High reliability for infrastructure cooling

**UNIQUE**

## Select your infrastructure cooling system in 2 steps

### No humidity generation in room (eg: Server room)

IT room requires 22°C inside. It will have 7kW of sensible cooling demand, and no latent cooling demand (no humidity generation) throughout the year. Ceiling suspended indoor unit is the customer's preference for the server room.

- Indoor temperature = 22°CDB
- Sensible cooling demand (SHC) = 7 kW
- Latent cooling demand (LC) = 0 kW\*
- Total cooling demand (TC) = SHC + LC = 7 kW
- Outdoor temperature operating range = -20°C ~ +40°C
- Most stringent outdoor unit capacity condition = -20°C

**SOLUTION**

### Boosted capacity indoor combination with 10kW outdoor system.

- RZAG100 + FHA140
- Total capacity = 7.48 kW
- Sensible capacity = 7.48 kW
- Power input = 0.42 x 1.96 = 0.82 kW

\* If there is no latent cooling demand, look for conditions where TC = SHC, since no more dehumidification will occur and thus the indoor environment will stabilize. When TC > SHC and there is no humidity generation, the indoor humidity will gradually decrease.

### STEP 1

Determine requested indoor conditions and required cooling demand (Sensible and Total capacity)

### STEP 2

Select the system combination from the given table, where the system's sensible and total capacity meets the cooling demand at the requested indoor and outdoor temperatures.

### Some humidity source in room (eg: Laboratory)

Lab requires 22°C inside. It will have 9 kW of sensible cooling demand, and some humidity generation in the room (est. indoor humidity level 42%). Wall mounted indoor unit is the customer's preference for the laboratory.

- Indoor temperature = 22°CDB
- Indoor Relative Humidity (RH%) = 42%\*\*
- Sensible cooling demand (SHC) = 9 kW
- Latent cooling demand (LC) = 0.9 kW
- Total cooling demand (TC) = SHC + LC = 9.9 kW
- Outdoor temperature operating range = -20°C ~ +40°C
- Most stringent outdoor unit capacity condition = -20°C

**SOLUTION**

### Boosted capacity indoor combination with 12.5kW outdoor system.

- RZAG125 + FAA71x2
- Total capacity = 10.39 kW
- Sensible capacity = 9.34 kW
- Power input = 0.46 x 2.65 = 1.22 kW

\*\* System capacity at 42%RH (14,2°CWB) can be found by interpolation between 13°CWB (35%) and 15°CWB (48%).

## Combination table for boosted capacity indoor systems

Infrastructure cooling combination table

capacity class	FTXM-N				FAA-B				FHA-A(9)				FBA-A(9)				FDXM-F9				FUA-A				FNA-A9				FVA-A				FFA-A9				FCAHG-H				FCAG-B				
	35	50	60	71	71	100	35	50	60	71	100	125	140	35	50	60	71	100	125	140	35	50	60	71	100	125	140	35	50	60	71	100	125	140	35	50	60	71	100	125	140				
RZAG35A	P																																												
RZAG50A		P																																											
RZAG60A			P																																										
RZAG71				P	3	2								3	2																														
RZAG100					2	4	3		2					P	4	3	2									2																			
RZAG125					2	4	3		2					P	4	3	2									2																			
RZAG140					2	4	3		2					P	4	3	2									2																			

P = Pair, 2 = Twin, 3 = Triple, 4 = Double twin; For more information on infrastructure cooling options refer to infrastructure cooling catalogue.

Possible combinations: P = Pair 2 = Twin 3 = Triple 4 = Double Twin

Notes: For R-410A combinations please refer to the outdoor unit pages.

# Performance characteristics

for boosted capacity indoor combinations with most common indoor units

## Boosted capacity indoor unit with 3.5kW outdoor system

### RZAG35A / FTXM50N

Indoor temperature		Outdoor temperature [°C DB]																																										
		-20			-15			-10			-5			0			5			10			15			20			25			30			35			40						
RH[%]	°C	°C	°C	°C	°C	°C	°C	°C	°C	°C	°C	°C	°C	°C	°C	°C	°C	°C	°C	°C	°C	°C	°C	°C	°C	°C	°C	°C	°C	°C	°C	°C	°C	°C	°C	°C	°C							
41.8	11	18	2.91	2.91	0.26	2.91	2.91	0.28	2.91	2.91	0.30	2.91	2.91	0.33	2.91	2.91	0.36	2.91	2.91	0.39	2.91	2.91	0.42	2.91	2.91	0.49	2.91	2.91	0.57	2.91	2.91	0.64	2.91	2.91	0.72	2.85	2.85	0.80	2.69	2.69	0.86			
57.0	13	18	3.51	2.70	0.34	3.51	2.70	0.37	3.51	2.70	0.40	3.51	2.70	0.43	3.51	2.70	0.47	3.51	2.70	0.50	3.51	2.70	0.55	3.51	2.70	0.62	3.51	2.70	0.70	3.51	2.70	0.78	3.18	2.54	0.74	3.02	2.46	0.80	2.85	2.38	0.86			
31.4	11	20	2.90	2.90	0.26	2.90	2.90	0.28	2.90	2.90	0.30	2.90	2.90	0.33	2.90	2.90	0.36	2.90	2.90	0.39	2.90	2.90	0.42	2.90	2.90	0.49	2.90	2.90	0.57	2.90	2.90	0.64	2.90	2.90	0.72	2.85	2.85	0.80	2.69	2.69	0.86			
44.9	13	20	3.51	3.15	0.34	3.51	3.15	0.37	3.51	3.15	0.40	3.51	3.15	0.43	3.51	3.15	0.47	3.51	3.15	0.50	3.51	3.15	0.55	3.51	3.15	0.62	3.51	3.15	0.70	3.51	3.15	0.78	3.18	3.00	0.74	3.02	2.92	0.80	2.85	2.84	0.86			
52.0	14	20	3.59	2.90	0.44	3.59	2.90	0.47	3.59	2.90	0.50	3.59	2.90	0.53	3.59	2.90	0.57	3.59	2.90	0.60	3.59	2.90	0.65	3.59	2.90	0.72	3.59	2.90	0.80	3.59	2.90	0.88	3.26	2.75	0.74	3.10	2.68	0.80	2.93	2.60	0.86			
22.9	11	22	2.89	2.89	0.25	2.89	2.89	0.28	2.89	2.89	0.30	2.89	2.89	0.33	2.89	2.89	0.36	2.89	2.89	0.39	2.89	2.89	0.42	2.89	2.89	0.49	2.89	2.89	0.56	2.89	2.89	0.64	2.89	2.89	0.72	2.85	2.85	0.80	2.69	2.69	0.86			
34.8	13	22	3.51	3.51	0.34	3.51	3.51	0.37	3.51	3.51	0.40	3.51	3.51	0.43	3.51	3.51	0.47	3.51	3.51	0.50	3.51	3.51	0.55	3.51	3.51	0.62	3.51	3.51	0.70	3.51	3.51	0.78	3.18	3.18	0.74	3.02	3.02	0.80	2.85	2.85	0.86			
47.6	15	22	3.67	3.11	0.50	3.67	3.11	0.53	3.67	3.11	0.56	3.67	3.11	0.59	3.67	3.11	0.63	3.67	3.11	0.66	3.67	3.11	0.70	3.67	3.11	0.75	3.67	3.11	0.80	3.67	3.11	0.85	3.50	3.04	0.68	3.34	2.96	0.74	3.18	2.89	0.80	3.01	2.82	0.86
54.3	16	22	3.75	2.86	0.51	3.75	2.86	0.54	3.75	2.86	0.57	3.75	2.86	0.60	3.75	2.86	0.63	3.75	2.86	0.66	3.75	2.86	0.70	3.75	2.86	0.75	3.75	2.86	0.80	3.75	2.86	0.85	3.58	3.04	0.68	3.34	2.96	0.74	3.18	2.89	0.80	3.01	2.82	0.86
21.2	12	24	3.42	3.42	0.29	3.42	3.42	0.31	3.42	3.42	0.34	3.42	3.42	0.37	3.42	3.42	0.40	3.42	3.42	0.43	3.42	3.42	0.47	3.42	3.42	0.54	3.42	3.42	0.62	3.42	3.42	0.68	3.10	3.10	0.74	2.94	2.94	0.80	2.77	2.77	0.86			
32.1	14	24	3.59	3.59	0.44	3.59	3.59	0.47	3.59	3.59	0.50	3.59	3.59	0.53	3.59	3.59	0.57	3.59	3.59	0.60	3.59	3.59	0.65	3.59	3.59	0.72	3.59	3.59	0.80	3.59	3.59	0.88	3.26	3.26	0.74	3.10	3.10	0.80	2.93	2.93	0.86			
43.8	16	24	3.75	3.31	0.51	3.75	3.31	0.54	3.75	3.31	0.57	3.75	3.31	0.60	3.75	3.31	0.63	3.75	3.31	0.66	3.75	3.31	0.70	3.75	3.31	0.75	3.75	3.31	0.80	3.75	3.31	0.85	3.58	3.24	0.68	3.42	3.17	0.74	3.26	3.10	0.80	3.10	3.03	0.86
50.0	17	24	3.83	3.06	0.51	3.83	3.06	0.54	3.83	3.06	0.57	3.83	3.06	0.60	3.83	3.06	0.63	3.83	3.06	0.66	3.83	3.06	0.70	3.83	3.06	0.75	3.83	3.06	0.80	3.83	3.06	0.85	3.66	2.99	0.69	3.50	2.92	0.75	3.34	2.85	0.81	3.18	2.78	0.87
21.5	14	27	3.59	3.59	0.44	3.59	3.59	0.47	3.59	3.59	0.50	3.59	3.59	0.53	3.59	3.59	0.57	3.59	3.59	0.60	3.59	3.59	0.65	3.59	3.59	0.72	3.59	3.59	0.80	3.59	3.59	0.88	3.26	3.26	0.74	3.10	3.10	0.80	2.93	2.93	0.86			
26.3	15	27	3.67	3.67	0.50	3.67	3.67	0.53	3.67	3.67	0.56	3.67	3.67	0.59	3.67	3.67	0.63	3.67	3.67	0.66	3.67	3.67	0.70	3.67	3.67	0.75	3.67	3.67	0.80	3.67	3.67	0.85	3.67	3.67	0.90	3.67	3.67	0.95	3.67	3.67	0.95	3.67	3.67	0.95
31.3	16	27	3.75	3.75	0.51	3.75	3.75	0.54	3.75	3.75	0.57	3.75	3.75	0.60	3.75	3.75	0.63	3.75	3.75	0.66	3.75	3.75	0.70	3.75	3.75	0.75	3.75	3.75	0.80	3.75	3.75	0.85	3.75	3.75	0.90	3.75	3.75	0.95	3.75	3.75	0.95			

3D122105A

### RZAG35A / FHA50A9

Indoor		Outdoor temperature [°C DB]																																										
		-20			-15			-10			-5			0			5			10			15			20			25			30			35			40						
RH[%]	°C	°C	°C	°C	°C	°C	°C	°C	°C	°C	°C	°C	°C	°C	°C	°C	°C	°C	°C	°C	°C	°C	°C	°C	°C	°C	°C	°C	°C	°C	°C	°C	°C	°C	°C	°C	°C	°C	°C	°C	°C			
41.8	11	18	2.82	2.82	0.21	2.82	2.82	0.24	2.82	2.82	0.26	2.82	2.82	0.29	2.82	2.82	0.34	2.82	2.82	0.41	2.82	2.82	0.48	2.82	2.82	0.55	2.82	2.82	0.63	2.82	2.82	0.71	2.82	2.82	0.80	2.69	2.69	0.87						
57.0	13	18	3.51	2.67	0.28	3.51	2.67	0.31	3.51	2.67	0.34	3.51	2.67	0.37	3.51	2.67	0.40	3.51	2.67	0.44	3.51	2.67	0.51	3.51	2.67	0.57	3.51	2.67	0.63	3.51	2.67	0.69	3.18	2.51	0.75	3.02	2.43	0.81	2.85	2.35	0.87			
31.4	11	20	2.81	2.81	0.21	2.81	2.81	0.24	2.81	2.81	0.26	2.81	2.81	0.28	2.81	2.81	0.31	2.81	2.81	0.34	2.81	2.81	0.37	2.81	2.81	0.41	2.81	2.81	0.47	2.81	2.81	0.55	2.81	2.81	0.63	2.81	2.81	0.71	2.81	2.81	0.80	2.69	2.69	0.87
44.9	13	20	3.51	3.11	0.28	3.51	3.11	0.31	3.51	3.11	0.34	3.51	3.11	0.37	3.51	3.11	0.40	3.51	3.11	0.44	3.51	3.11	0.48	3.51	3.11	0.57	3.51	3.11	0.63	3.51	3.11	0.69	3.18	2.95	0.75	3.02	2.87	0.81	2.85	2.79	0.87			
52.0	14	20	3.59	2.87	0.35	3.59	2.87	0.38	3.59	2.87	0.42	3.59	2.87	0.45	3.59	2.87	0.48	3.59	2.87	0.51	3.59	2.87	0.55	3.59	2.87	0.62	3.59	2.87	0.69	3.59	2.87	0.75	3.10	2.64	0.81	2.93	2.56	0.87						
22.9	11	22	2.81	2.81	0.21	2.81	2.81	0.23	2.81	2.81	0.26	2.81	2.81	0.28	2.81	2.81	0.31	2.81	2.81	0.34	2.81	2.81	0.37	2.81	2.81	0.41	2.81	2.81	0.47	2.81	2.81	0.55	2.81	2.81	0.63	2.81	2.81	0.71	2.81	2.81	0.80	2.69	2.69	0.87
34.8	13	22	3.51	3.51	0.28	3.51	3.51	0.31	3.51	3.51	0.34	3.51	3.51	0.37	3.51	3.51	0.40	3.51	3.51	0.44	3.51	3.51	0.48	3.51	3.51	0.55	3.51	3.51	0.63	3.51	3.51	0.71	3.51	3.51	0.79	3.18	3.18	0.75	3.02	3.02	0.81	2.85	2.85	0.87
47.6	15	22	3.67	3.07	0.45	3.67	3.07	0.48	3.67	3.07	0.51	3.67	3.07	0.54	3.67	3.07	0.57	3.67	3.07	0.60	3.67	3.07	0.64	3.67	3.07	0.70	3.67	3.07	0.77	3.67	3.07	0.84	3.50	2.99	0.69	3.34	2.92	0.75	3.18	2.84	0.82	3.01	2.77	0.88
54.3	16	22	3.75	2.82	0.51	3.75	2.82	0.54	3.75	2.82	0.57	3.75	2.82	0.60	3.75	2.82	0.63	3.75	2.82	0.66	3.75	2.82	0.70	3.75	2.82	0.75	3.75	2.82	0.80	3.75	2.82	0.85	3.58	2.75	0.70	3.42	2.67	0.76	3.26	2.60	0.82	3.10	2.53	0.88
21.2	12	24	3.33	3.33	0.25	3.33	3.33	0.27	3.33	3.33</																																		



**Symbols**

TC: Maximum total cooling capacity [kW]  
 SHC: Sensible heat capacity [kW]  
 CPI: Coefficient of the power input  
 PI: Power input [kW] Compressor + indoor and outdoor fan motors  
 RH: Relative humidity [%]

## Boosted capacity indoor unit with 5kW outdoor system

### RZAG50A / FTXM60N

Indoor temperature		Outdoor temperature [°C DB]																																							
		-20			-15			-10			-5			0			5			10			15			20			25			30			35			40			
RH[%]	°C	°C	°C	°C	°C	°C	°C	°C	°C	°C	°C	°C	°C	°C	°C	°C	°C	°C	°C	°C	°C	°C	°C	°C	°C	°C	°C	°C	°C	°C	°C	°C	°C	°C	°C	°C	°C	°C	°C		
41.8	11	18	3.27	3.27	0.44	3.27	3.27	0.47	3.27	3.27	0.51	3.27	3.27	0.56	3.27	3.27	0.62	3.27	3.27	0.68	3.27	3.27	0.75	3.27	3.27	0.85	3.27	3.27	0.94	3.27	3.27	1.03	3.27	3.27	1.13	3.27	3.27	1.22	3.27	3.27	1.31
57.0	13	18	4.54	3.33	0.46	4.54	3.33	0.50	4.54	3.33	0.55	4.54	3.33	0.60	4.54	3.33	0.65	4.54	3.33	0.71	4.54	3.33	0.76	4.54	3.33	0.86	4.54	3.33	0.95	4.54	3.33	1.04	4.54	3.33	1.13	4.31	3.21	1.22	4.08	3.10	1.32
31.4	11	20	3.26	3.26	0.44	3.26	3.26	0.47	3.26	3.26	0.51	3.26	3.26	0.56	3.26	3.26	0.62	3.26	3.26	0.68	3.26	3.26	0.75	3.26	3.26	0.85	3.26	3.26	0.94	3.26	3.26	1.03	3.26	3.26	1.13	3.26	3.26	1.22	3.26	3.26	1.31
44.9	13	20	4.52	3.84	0.46	4.52	3.84	0.50	4.52	3.84	0.55	4.52	3.84	0.60	4.52	3.84	0.65	4.52	3.84	0.71	4.52	3.84	0.76	4.52	3.84	0.86	4.52	3.84	0.95	4.52	3.84	1.04	4.52	3.84	1.13	4.31	3.73	1.22	4.08	3.61	1.32
52.0	14	20	5.12	3.80	0.47	5.12	3.80	0.52	5.12	3.80	0.56	5.12	3.80	0.61	5.12	3.80	0.66	5.12	3.80	0.72	5.12	3.80	0.77	5.12	3.80	0.86	5.12	3.80	0.95	4.89	3.68	1.04	4.66	3.57	1.13	4.42	3.45	1.23	4.19	3.34	1.32
22.9	11	22	3.25	3.25	0.44	3.25	3.25	0.47	3.25	3.25	0.51	3.25	3.25	0.56	3.25	3.25	0.62	3.25	3.25	0.68	3.25	3.25	0.75	3.25	3.25	0.85	3.25	3.25	0.94	3.25	3.25	1.03	3.25	3.25	1.13	3.25	3.25	1.22	3.25	3.25	1.31
34.8	13	22	4.51	4.34	0.46	4.51	4.34	0.50	4.51	4.34	0.55	4.51	4.34	0.60	4.51	4.34	0.65	4.51	4.34	0.71	4.51	4.34	0.76	4.51	4.34	0.86	4.51	4.34	0.95	4.51	4.34	1.04	4.51	4.34	1.13	4.31	4.24	1.22	4.08	4.08	1.32
47.6	15	22	5.24	4.02	0.48	5.24	4.02	0.53	5.24	4.02	0.58	5.24	4.02	0.63	5.24	4.02	0.68	5.24	4.02	0.72	5.24	4.02	0.77	5.24	4.02	0.86	5.24	4.02	0.95	5.00	3.91	1.05	4.77	3.80	1.14	4.54	3.69	1.23	4.31	3.58	1.32
54.3	16	22	5.35	3.73	0.63	5.35	3.73	0.68	5.35	3.73	0.73	5.35	3.73	0.77	5.35	3.73	0.82	5.35	3.73	0.87	5.35	3.73	0.92	5.35	3.73	0.97	5.35	3.73	1.02	5.00	3.91	1.05	4.89	3.51	1.14	4.65	3.41	1.23	4.42	3.30	1.32
21.2	12	24	3.86	3.86	0.45	3.86	3.86	0.49	3.86	3.86	0.53	3.86	3.86	0.58	3.86	3.86	0.64	3.86	3.86	0.70	3.86	3.86	0.76	3.86	3.86	0.85	3.86	3.86	0.95	3.86	3.86	1.04	3.86	3.86	1.13	3.86	3.86	1.22	3.86	3.86	1.31
32.1	14	24	5.12	4.83	0.47	5.12	4.83	0.51	5.12	4.83	0.56	5.12	4.83	0.61	5.12	4.83	0.66	5.12	4.83	0.72	5.12	4.83	0.77	5.12	4.83	0.86	5.12	4.83	0.95	4.89	4.71	1.04	4.66	4.60	1.13	4.42	4.42	1.23	4.19	4.19	1.32
43.8	16	24	5.35	4.25	0.63	5.35	4.25	0.68	5.35	4.25	0.73	5.35	4.25	0.77	5.35	4.25	0.82	5.35	4.25	0.87	5.35	4.25	0.92	5.35	4.25	0.97	5.35	4.25	1.02	5.12	4.14	1.05	4.89	4.03	1.14	4.65	3.92	1.23	4.42	3.82	1.32
50.0	17	24	5.47	3.95	0.78	5.47	3.95	0.78	5.47	3.95	0.78	5.47	3.95	0.78	5.47	3.95	0.78	5.47	3.95	0.78	5.47	3.95	0.78	5.47	3.95	0.87	5.47	3.95	0.96	5.24	3.85	1.05	5.00	3.74	1.14	4.77	3.64	1.23	4.54	3.54	1.33
21.5	14	27	5.12	5.12	0.47	5.12	5.12	0.51	5.12	5.12	0.56	5.12	5.12	0.61	5.12	5.12	0.66	5.12	5.12	0.72	5.12	5.12	0.77	5.12	5.12	0.86	5.12	5.12	0.95	4.89	4.89	1.04	4.66	4.66	1.13	4.42	4.42	1.23	4.19	4.19	1.32
26.3	15	27	5.24	5.24	0.48	5.24	5.24	0.53	5.24	5.24	0.58	5.24	5.24	0.63	5.24	5.24	0.68	5.24	5.24	0.72	5.24	5.24	0.77	5.24	5.24	0.86	5.24	5.24	0.95	5.00	5.00	1.05	4.77	4.77	1.14	4.54	4.54	1.23	4.31	4.31	1.32
31.3	16	27	5.35	5.02	0.63	5.35	5.02	0.68	5.35	5.02	0.72	5.35	5.02	0.77	5.35	5.02	0.82	5.35	5.02	0.87	5.35	5.02	0.92	5.35	5.02	0.97	5.35	5.02	1.02	5.12	4.91	1.05	4.89	4.80	1.14	4.65	4.65	1.23	4.42	4.42	1.32

3D122107 A

### RZAG50A / FHA60A9

Indoor		Outdoor temperature [°C DB]																																																															
		-20			-15			-10			-5			0			5			10			15			20			25			30			35			40																											
RH[%]	°C	°C	°C	°C	°C	°C	°C	°C	°C	°C	°C	°C	°C	°C	°C	°C	°C	°C	°C	°C	°C	°C	°C	°C	°C	°C	°C	°C	°C	°C	°C	°C	°C	°C	°C	°C	°C	°C	°C	°C	°C																								
42.0	11	18	4.03	4.03	0.32	4.03	4.03	0.35	4.03	4.03	0.39	4.03	4.03	0.43	4.03	4.03	0.47	4.03	4.03	0.51	4.03	4.03	0.56	4.03	4.03	0.61	4.03	4.03	0.66	4.03	4.03	0.71	4.03	4.03	0.76	4.03	4.03	0.81	4.03	4.03	0.86	4.03	4.03	0.91	4.03	4.03	0.96	4.03	4.03	1.01	4.03	4.03	1.06	4.03	4.03	1.11	4.03	4.03	1.16	4.03	4.03	1.21	4.03	4.03	1.26
57.0	13	18	5.01	3.81	0.40	5.01	3.81	0.44	5.01	3.81	0.49	5.01	3.81	0.53	5.01	3.81	0.58	5.01	3.81	0.63	5.01	3.81	0.67	5.01	3.81	0.72	5.01	3.81	0.77	5.01	3.81	0.82	5.01	3.81	0.87	5.01	3.81	0.92	5.01	3.81	0.97	5.01	3.81	1.02	5.01	3.81	1.07	5.01	3.81	1.12	5.01	3.81	1.17	5.01	3.81	1.22	5.01	3.81	1.27	5.01	3.81	1.32			
31.0	11	20	4.02	4.02	0.32	4.02	4.02	0.35	4.02	4.02	0.39	4.02	4.02	0.43	4.02	4.02	0.47	4.02	4.02	0.51	4.02	4.02	0.56	4.02	4.02	0.61	4.02	4.02	0.66	4.02	4.02	0.71	4.02	4.02	0.76	4.02	4.02	0.81	4.02	4.02	0.86	4.02	4.02	0.91	4.02	4.02	0.96	4.02	4.02	1.01	4.02	4.02	1.06	4.02	4.02	1.11	4.02	4.02	1.16	4.02	4.02	1.21	4.02	4.02	1.26
45.0	13	20	5.01	4.44	0.40	5.01	4.44	0.44	5.01	4.44	0.49	5.01	4.44	0.53	5.01	4.44	0.58	5.01	4.44	0.63	5.01	4.44	0.67	5.01	4.44	0.72	5.01	4.44	0.77	5.01	4.44	0.82	5.01	4.44	0.87	5.01	4.44	0.92	5.01	4.44	0.97	5.01	4.44	1.02	5.01	4.44	1.07	5.01	4.44	1.12	5.01	4.44	1.17	5.01	4.44	1.22	5.01	4.44	1.27	5.01	4.44	1.32			
52.0	14	20	5.12	4.10	0.50	5.12	4.10	0.55	5.12	4.10	0.60	5.12	4.10	0.64	5.12	4.10	0.69	5.12	4.10	0.73	5.12	4.10	0.78	5.12	4.10	0.83	5.12	4.10	0.88	5.12	4.10	0.93	5.12	4.10	0.98	5.12	4.10	1.03	5.12	4.10	1.08	5.12	4.10	1.13	5.12	4.10	1.18	5.12	4.10	1.23	5.12	4.10	1.28	5.12	4.10	1.33									
23.0	11	22	4.01	4.01	0.32	4.01	4.01	0.35	4.01	4.01	0.39	4.01	4.01	0.43	4.01	4.01	0.47	4.01	4.01	0.51	4.01	4.01	0.56	4.01	4.01	0.61	4.01	4.01	0.66	4.01	4.01	0.71	4.01	4.01	0.76	4.01	4.01	0.81	4.01	4.01	0.86	4.01	4.01	0.91	4.01	4.01	0.96	4.01	4.01	1.01	4.01	4.01	1.06	4.01	4.01	1.11	4.01	4.01	1.16	4.01	4.01	1.21	4.01	4.01	1.26
35.0	13	22	5.01	5.01	0.40	5.01	5.01	0.44	5.01	5.01	0.48	5.01	5.01	0.53	5.01	5.01	0.58	5.01	5.01	0.63	5.01	5.01	0.67	5.01	5.01																																								

# Boosted capacity indoor unit with 6kW outdoor system

## RZAG60A / FTXM71N

Indoor			Outdoor temperature [°C DB]																																						
			-20			-15			-10			-5			0			5			10			15			20			25			30			35			40		
RH[%]	°C	°C	TC	SHC	PI	TC	SHC	PI	TC	SHC	PI	TC	SHC	PI	TC	SHC	PI	TC	SHC	PI	TC	SHC	PI	TC	SHC	PI	TC	SHC	PI	TC	SHC	PI	TC	SHC	PI	TC	SHC	PI	TC	SHC	PI
41.8	11	18	3.91	3.91	0.46	3.91	3.91	0.50	3.91	3.91	0.55	3.91	3.91	0.60	3.91	3.91	0.65	3.91	3.91	0.71	3.91	3.91	0.78	3.91	3.91	0.92	3.91	3.91	1.07	3.91	3.91	1.22	3.91	3.91	1.39	3.91	3.91	1.56	3.91	3.91	1.72
57.0	13	18	5.43	3.98	0.57	5.43	3.98	0.62	5.43	3.98	0.68	5.43	3.98	0.74	5.43	3.98	0.80	5.43	3.98	0.87	5.43	3.98	0.94	5.43	3.98	1.09	5.43	3.98	1.25	5.43	3.98	1.40	5.43	3.98	1.56	5.17	3.85	1.69	4.89	3.71	1.81
31.4	11	20	3.90	3.90	0.46	3.90	3.90	0.50	3.90	3.90	0.55	3.90	3.90	0.60	3.90	3.90	0.65	3.90	3.90	0.71	3.90	3.90	0.78	3.90	3.90	0.92	3.90	3.90	1.07	3.90	3.90	1.22	3.89	3.89	1.39	3.90	3.90	1.55	3.90	3.90	1.72
44.9	13	20	5.41	4.59	0.57	5.41	4.59	0.62	5.41	4.59	0.68	5.41	4.59	0.74	5.41	4.59	0.80	5.41	4.59	0.87	5.41	4.59	0.94	5.41	4.59	1.09	5.41	4.59	1.24	5.41	4.59	1.40	5.41	4.59	1.56	5.17	4.47	1.69	4.89	4.33	1.81
52.0	14	20	6.15	4.55	0.62	6.15	4.55	0.68	6.15	4.55	0.74	6.15	4.55	0.80	6.15	4.55	0.87	6.15	4.55	0.94	6.15	4.55	1.01	6.15	4.55	1.16	6.15	4.55	1.31	5.87	4.41	1.44	5.59	4.28	1.56	5.31	4.14	1.69	5.03	4.00	1.82
22.9	11	22	3.89	3.89	0.46	3.89	3.89	0.50	3.89	3.89	0.55	3.89	3.89	0.59	3.89	3.89	0.65	3.89	3.89	0.71	3.89	3.89	0.77	3.89	3.89	0.91	3.89	3.89	1.06	3.89	3.89	1.22	3.89	3.89	1.39	3.90	3.90	1.55	3.89	3.89	1.72
34.8	13	22	5.40	5.20	0.57	5.40	5.20	0.62	5.40	5.20	0.68	5.40	5.20	0.74	5.40	5.20	0.80	5.40	5.20	0.87	5.40	5.20	0.94	5.40	5.20	1.09	5.40	5.20	1.24	5.40	5.20	1.40	5.40	5.20	1.56	5.17	5.08	1.69	4.89	4.89	1.81
47.6	15	22	6.29	4.82	0.66	6.29	4.82	0.72	6.29	4.82	0.78	6.29	4.82	0.85	6.29	4.82	0.92	6.29	4.82	1.00	6.29	4.82	1.06	6.29	4.82	1.19	6.29	4.82	1.32	6.01	4.69	1.44	5.73	4.55	1.57	5.45	4.42	1.69	5.17	4.29	1.82
54.3	16	22	6.42	4.47	0.86	6.42	4.47	0.93	6.42	4.47	1.00	6.42	4.47	1.07	6.42	4.47	1.14	6.42	4.47	1.21	6.42	4.47	1.28	6.42	4.47	1.41	6.42	4.47	1.54	6.14	4.34	1.45	5.86	4.21	1.57	5.59	4.08	1.70	5.31	3.96	1.83
21.2	12	24	4.62	4.62	0.52	4.62	4.62	0.56	4.62	4.62	0.61	4.62	4.62	0.67	4.62	4.62	0.73	4.62	4.62	0.79	4.62	4.62	0.86	4.62	4.62	1.00	4.62	4.62	1.16	4.62	4.62	1.32	4.62	4.62	1.48	4.62	4.62	1.64	4.62	4.62	1.80
32.1	14	24	6.15	5.79	0.62	6.15	5.79	0.68	6.15	5.79	0.73	6.15	5.79	0.80	6.15	5.79	0.87	6.15	5.79	0.94	6.15	5.79	1.01	6.15	5.79	1.16	6.15	5.79	1.31	5.87	5.64	1.44	5.59	5.51	1.56	5.31	5.31	1.69	5.03	5.03	1.82
43.8	16	24	6.42	5.09	0.62	6.42	5.09	0.93	6.42	5.09	1.00	6.42	5.09	1.07	6.42	5.09	1.14	6.42	5.09	1.21	6.42	5.09	1.28	6.42	5.09	1.41	6.42	5.09	1.54	6.14	4.96	1.45	5.86	4.83	1.57	5.59	4.70	1.70	5.31	4.57	1.83
50.0	17	24	6.56	4.74	1.01	6.56	4.74	1.07	6.56	4.74	1.14	6.56	4.74	1.21	6.56	4.74	1.28	6.56	4.74	1.35	6.56	4.74	1.42	6.56	4.74	1.55	6.56	4.74	1.68	6.28	4.61	1.45	6.00	4.48	1.58	5.72	4.36	1.70	5.44	4.24	1.83
21.5	14	27	6.15	6.15	0.62	6.15	6.15	0.67	6.15	6.15	0.73	6.15	6.15	0.80	6.15	6.15	0.86	6.15	6.15	0.93	6.15	6.15	1.01	6.15	6.15	1.16	6.15	6.15	1.31	5.87	5.87	1.44	5.59	5.59	1.56	5.31	5.31	1.69	5.03	5.03	1.82
26.3	15	27	6.29	6.29	0.66	6.29	6.29	0.72	6.29	6.29	0.78	6.29	6.29	0.85	6.29	6.29	0.92	6.29	6.29	0.99	6.29	6.29	1.06	6.29	6.29	1.19	6.29	6.29	1.32	6.01	6.01	1.44	5.73	5.73	1.57	5.45	5.45	1.69	5.17	5.17	1.82
31.3	16	27	6.42	6.01	0.86	6.42	6.01	0.93	6.42	6.01	1.00	6.42	6.01	1.07	6.42	6.01	1.14	6.42	6.01	1.21	6.42	6.01	1.28	6.42	6.01	1.41	6.42	6.01	1.54	6.14	5.88	1.45	5.86	5.75	1.57	5.59	5.59	1.70	5.31	5.31	1.83

3D12109 A

## RZAG60A / FHA71A9

Indoor			Outdoor temperature [°C DB]																																									
			-20			-15			-10			-5			0			5			10			15			20			25			30			35			40					
RH[%]	°C	°C	TC	SHC	PI	TC	SHC	PI	TC	SHC	PI	TC	SHC	PI	TC	SHC	PI	TC	SHC	PI	TC	SHC	PI	TC	SHC	PI	TC	SHC	PI	TC	SHC	PI	TC	SHC	PI	TC	SHC	PI	TC	SHC	PI	TC	SHC	PI
42.0	11	18	4.61	4.61	0.41	4.61	4.61	0.45	4.61	4.61	0.50	4.61	4.61	0.55	4.61	4.61	0.61	4.61	4.61	0.67	4.61	4.61	0.80	4.61	4.61	0.93	4.61	4.61	1.05	4.61	4.61	1.15	4.61	4.61	1.25	4.61	4.61	1.35	4.61	4.61	1.46			
57.0	13	18	6.01	4.50	0.47	6.01	4.50	0.51	6.01	4.50	0.57	6.01	4.50	0.62	6.01	4.50	0.68	6.01	4.50	0.74	6.01	4.50	0.85	6.01	4.50	0.95	6.01	4.50	1.05	5.73	4.36	1.16	5.45	4.22	1.26	5.17	4.08	1.36	4.89	3.95	1.46			
31.0	11	20	4.59	4.59	0.41	4.59	4.59	0.45	4.59	4.59	0.50	4.59	4.59	0.55	4.59	4.59	0.61	4.59	4.59	0.67	4.59	4.59	0.74	4.59	4.59	0.80	4.59	4.59	0.93	4.59	4.59	1.05	4.59	4.59	1.15	4.59	4.59	1.25	4.59	4.59	1.35	4.59	4.59	1.46
45.0	13	20	6.01	5.22	0.47	6.01	5.22	0.51	6.01	5.22	0.57	6.01	5.22	0.62	6.01	5.22	0.68	6.01	5.22	0.74	6.01	5.22	0.85	6.01	5.22	0.95	6.01	5.22	1.05	5.73	5.08	1.16	5.45	4.94	1.26	5.17	4.81	1.36	4.89	4.67	1.46			
52.0	14	20	6.15	4.82	0.54	6.15	4.82	0.59	6.15	4.82	0.64	6.15	4.82	0.70	6.15	4.82	0.75	6.15	4.82	0.81	6.15	4.82	0.88	6.15	4.82	0.96	6.15	4.82	1.06	5.87	4.69	1.16	5.59	4.56	1.26	5.31	4.42	1.36	5.03	4.29	1.47			
23.0	11	22	4.58	4.58	0.41	4.58	4.58	0.45	4.58	4.58	0.50	4.58	4.58	0.55	4.58	4.58	0.61	4.58	4.58	0.67	4.58	4.58	0.74	4.58	4.58	0.80	4.58	4.58	0.93	4.58	4.58	1.05	4.58	4.58	1.15	4.58	4.58	1.25	4.58	4.58	1.35	4.58	4.58	1.46
35.0	13	22	6.01	5.94	0.47	6.01	5.94	0.51	6.01	5.94	0.57	6.01	5.94	0.62	6.01	5.94	0.68	6.01	5.94	0.74	6.01	5.94	0.85	6.01	5.94	0.95	6.01	5.94	1.05	5.73	5.73	1.16	5.45	5.45	1.26	5.17	5.17	1.36	4.89	4.89	1.46			
48.0	15	22	6.29	5.15	0.70	6.29	5.15	0.76	6.29	5.15	0.82	6.29	5.15	0.88	6.29	5.15	0.94	6.29	5.15	1.00	6.29	5.15	1.06	6.29	5.15	1.12	6.29	5.15	1.18	6.01	5.02	1.16	5.73	4.89	1.26	5.45	4.76	1.37	5.17	4.63	1.47			
54.0	16	22	6.42	4.74	0.86	6.42	4.74	0.92	6.42	4.74	0.98	6.42	4.74	1.04	6.42	4.74	1.10	6.42	4.74	1.16	6.42	4.74	1.22	6.42	4.74	1.28	6.42	4.74	1.34	6.14	4.62	1.17	5.86	4.49	1.27	5.59	4.37	1.37	5.31	4.25	1.47			
21.0	12	24	5.44	5.44	0.44	5.44	5.44	0.48	5.44	5.44	0.53	5.44	5.44	0.59	5.44	5.44	0.64	5.44	5.44	0.70	5.44	5.44	0.76	5.44	5.44	0.82	5.44	5.44	0.94	5.44	5.44	1.05	5.44	5.44	1.15	5.31	5.31	1.26	5.03	5.03	1.36	4.75	4.75	1.46
32.0	14	24	6.15	6.15	0.54	6.15	6.15	0.59	6.15	6.15	0.64	6.15	6.15	0.70	6.15	6.15	0.75	6.15	6.15	0.81	6.15	6.15	0.87	6.15	6.15	0.93	6.15	6.15	1.06	5.87	5.87	1.16	5.59	5.59	1.26	5.31	5.31	1.36	5.03	5.03	1.47			
44.0	16	24	6.42	5.47	0.86	6.42	5.47	0.92	6.42	5.47	0.98	6.42	5.47	1.04	6.42	5.47	1.10	6.42	5.47	1.16	6.42	5.47	1.22	6.42	5.47	1.28	6.42	5.47	1.34	6.14	4.62	1.17	5.86	4.49	1.27	5.59	4.37	1.37	5.31	4.97	1.47			
50.0	17	24	6.56	5.06	0.86	6.56	5.06	0.92	6.56	5.06	0.98	6.56	5.06	1.04	6.56	5.06	1.10	6.56	5.06	1.16	6.56	5.06	1.22	6.56	5.06	1.28	6.56	5.06	1.34	6.28	4.93													

# Boosted capacity indoor unit with 7kW outdoor system

## RZAG71NV1 / RZAG71NY1

Indoor			Outdoor temperature [°C DB]																																												
			-20			-15			-10			-5			0			5			10			15			20			25			30			35			40								
			TC	SHC	CPI	TC	SHC	CPI	TC	SHC	CPI	TC	SHC	CPI	TC	SHC	CPI	TC	SHC	CPI	TC	SHC	CPI	TC	SHC	CPI	TC	SHC	CPI	TC	SHC	CPI	TC	SHC	CPI	TC	SHC	CPI	TC	SHC	CPI						
RH[%]	°CWB	°CDB	kW	kW	-	kW	kW	-	kW	kW	-	kW	kW	-	kW	kW	-	kW	kW	-	kW	kW	-	kW	kW	-	kW	kW	-	kW	kW	-	kW	kW	-	kW	kW	-	kW	kW	-	kW	kW	-			
41.8	11	18	4.81	4.67	0.32	4.81	4.67	0.34	4.81	4.67	0.36	4.81	4.67	0.37	4.81	4.67	0.39	4.81	4.67	0.41	4.81	4.67	0.43	4.81	4.67	0.46	4.81	4.67	0.48	4.81	4.67	0.48	4.81	4.67	0.48	4.81	4.67	0.48	4.81	4.67	0.48	4.81	4.67	0.48	4.81	4.67	0.48
57.0	13		6.02	5.05	0.33	6.02	5.05	0.37	6.02	5.05	0.41	6.02	5.05	0.45	6.02	5.05	0.50	6.02	5.05	0.52	6.02	5.05	0.55	6.02	5.05	0.57	6.02	5.05	0.64	6.02	5.05	0.64	6.02	5.05	0.64	6.02	5.05	0.64	6.02	5.05	0.64	6.02	5.05	0.64	6.02	5.05	0.64
31.4	11		4.81	4.81	0.32	4.81	4.81	0.34	4.81	4.81	0.36	4.81	4.81	0.37	4.81	4.81	0.39	4.81	4.81	0.41	4.81	4.81	0.43	4.81	4.81	0.46	4.81	4.81	0.48	4.81	4.81	0.48	4.81	4.81	0.48	4.81	4.81	0.48	4.81	4.81	0.48	4.81	4.81	0.48	4.81	4.81	0.48
44.9	13	20	6.02	6.02	0.33	6.02	6.02	0.37	6.02	6.02	0.41	6.02	6.02	0.45	6.02	6.02	0.50	6.02	6.02	0.52	6.02	6.02	0.55	6.02	6.02	0.57	6.02	6.02	0.64	6.02	6.02	0.64	6.02	6.02	0.64	6.02	6.02	0.64	6.02	6.02	0.64	6.02	6.02	0.64	6.02	6.02	0.64
52.0	14		6.62	5.76	0.34	6.62	5.76	0.38	6.62	5.76	0.44	6.62	5.76	0.50	6.62	5.76	0.55	6.62	5.76	0.58	6.62	5.76	0.60	6.62	5.76	0.63	6.62	5.76	0.72	6.62	5.76	0.72	6.62	5.76	0.72	6.62	5.76	0.72	6.62	5.76	0.72	6.62	5.76	0.72	6.62	5.76	0.72
22.9	11		4.81	4.81	0.32	4.81	4.81	0.34	4.81	4.81	0.36	4.81	4.81	0.37	4.81	4.81	0.39	4.81	4.81	0.41	4.81	4.81	0.43	4.81	4.81	0.46	4.81	4.81	0.48	4.81	4.81	0.48	4.81	4.81	0.48	4.81	4.81	0.48	4.81	4.81	0.48	4.81	4.81	0.48	4.81	4.81	0.48
34.8	13	22	6.02	6.02	0.33	6.02	6.02	0.37	6.02	6.02	0.41	6.02	6.02	0.45	6.02	6.02	0.50	6.02	6.02	0.52	6.02	6.02	0.55	6.02	6.02	0.57	6.02	6.02	0.64	6.02	6.02	0.64	6.02	6.02	0.64	6.02	6.02	0.64	6.02	6.02	0.64	6.02	6.02	0.64	6.02	6.02	0.64
47.6	15		7.22	6.06	0.34	7.22	6.06	0.39	7.22	6.06	0.46	7.22	6.06	0.54	7.22	6.06	0.61	7.22	6.06	0.63	7.22	6.06	0.66	7.22	6.06	0.69	7.22	6.06	0.79	7.22	6.06	0.79	7.22	6.06	0.79	7.22	6.06	0.79	7.22	6.06	0.79	7.22	6.06	0.79	7.22	6.06	0.79
54.3	16		7.82	5.71	0.35	7.82	5.71	0.41	7.82	5.71	0.49	7.82	5.71	0.58	7.82	5.71	0.66	7.82	5.71	0.69	7.82	5.71	0.72	7.82	5.71	0.75	7.82	5.71	0.87	7.82	5.71	0.87	7.82	5.71	0.87	7.82	5.71	0.87	7.82	5.71	0.87	7.82	5.71	0.87	7.82	5.71	0.87
21.2	12		5.41	5.41	0.33	5.41	5.41	0.36	5.41	5.41	0.38	5.41	5.41	0.41	5.41	5.41	0.44	5.41	5.41	0.46	5.41	5.41	0.49	5.41	5.41	0.52	5.41	5.41	0.56	5.41	5.41	0.56	5.41	5.41	0.56	5.41	5.41	0.56	5.41	5.41	0.56	5.41	5.41	0.56			
32.1	14		6.62	6.62	0.34	6.62	6.62	0.38	6.62	6.62	0.44	6.62	6.62	0.50	6.62	6.62	0.55	6.62	6.62	0.58	6.62	6.62	0.60	6.62	6.62	0.63	6.62	6.62	0.72	6.62	6.62	0.72	6.62	6.62	0.72	6.62	6.62	0.72	6.62	6.62	0.72	6.62	6.62	0.72			
43.8	16		7.82	6.57	0.35	7.82	6.57	0.41	7.82	6.57	0.49	7.82	6.57	0.58	7.82	6.57	0.66	7.82	6.57	0.69	7.82	6.57	0.72	7.82	6.57	0.75	7.82	6.57	0.87	7.82	6.57	0.87	7.82	6.57	0.87	7.82	6.57	0.87	7.82	6.57	0.87	7.82	6.57	0.87			
50.0	17		8.10	6.08	0.37	8.10	6.08	0.43	8.10	6.08	0.51	8.10	6.08	0.60	8.10	6.08	0.68	8.10	6.08	0.70	8.10	6.08	0.73	8.10	6.08	0.75	8.10	6.08	0.88	8.10	6.08	0.88	8.10	6.08	0.88	8.10	6.08	0.88	8.10	6.08	0.88	8.10	6.08	0.88			
21.5	14		6.62	6.62	0.34	6.62	6.62	0.38	6.62	6.62	0.44	6.62	6.62	0.50	6.62	6.62	0.55	6.62	6.62	0.58	6.62	6.62	0.60	6.62	6.62	0.63	6.62	6.62	0.72	6.62	6.62	0.72	6.62	6.62	0.72	6.62	6.62	0.72	6.62	6.62	0.72	6.62	6.62	0.72			
26.3	15	27	7.22	7.22	0.34	7.22	7.22	0.39	7.22	7.22	0.46	7.22	7.22	0.54	7.22	7.22	0.61	7.22	7.22	0.63	7.22	7.22	0.66	7.22	7.22	0.69	7.22	7.22	0.79	7.22	7.22	0.79	7.22	7.22	0.79	7.22	7.22	0.79	7.22	7.22	0.79	7.22	7.22	0.79			
31.3	16		7.82	7.82	0.35	7.82	7.82	0.41	7.82	7.82	0.49	7.82	7.82	0.58	7.82	7.82	0.66	7.82	7.82	0.69	7.82	7.82	0.72	7.82	7.82	0.75	7.82	7.82	0.87	7.82	7.82	0.87	7.82	7.82	0.87	7.82	7.82	0.87	7.82	7.82	0.87						

PAIR	FCAHG100H	FCAG100B	FAA100B	FVA100A	FHA100A	FUA100A	FUB100A
Cooling	1.64	1.64	1.80	1.72	1.69	1.69	1.64
TWIN	FCAG50B X 2	FHA50A X 2	FFA50A X 2	FDXM50F X 2	FBA50A X 2		
Cooling	1.56	1.70	1.79	1.44	1.67		
TRIPLE	FCAG35B X 3	FHA35A X 3	FFA35A X 3	FDXM35F9 X 3	FBA35A x 3		
Cooling	1.51	1.51	1.62	1.51	1.64		

3D125184 A

# Boosted capacity indoor unit with 10kW outdoor system

## RZAG100NV1 / RZAG100NY1

Indoor			Outdoor temperature [°C DB]																																												
			-20			-15			-10			-5			0			5			10			15			20			25			30			35			40								
			TC	SHC	CPI	TC	SHC	CPI	TC	SHC	CPI	TC	SHC	CPI	TC	SHC	CPI	TC	SHC	CPI	TC	SHC	CPI	TC	SHC	CPI	TC	SHC	CPI	TC	SHC	CPI	TC	SHC	CPI	TC	SHC	CPI	TC	SHC	CPI						
RH[%]	°CWB	°CDB	kW	kW	-	kW	kW	-	kW	kW	-	kW	kW	-	kW	kW	-	kW	kW	-	kW	kW	-	kW	kW	-	kW	kW	-	kW	kW	-	kW	kW	-	kW	kW	-	kW	kW	-	kW	kW	-			
41.8	11	18	6.00	6.00	0.32	6.00	6.00	0.33	6.00	6.00	0.34	6.00	6.00	0.35	6.00	6.00	0.37	6.00	6.00	0.38	6.00	6.00	0.38	6.00	6.00	0.39	6.00	6.00	0.39	6.00	6.00	0.39	6.00	6.00	0.39	6.00	6.00	0.39	6.00	6.00	0.39	6.00	6.00	0.39	6.00	6.00	0.39
57.0	13		7.48	6.37	0.42	7.48	6.37	0.42	7.48	6.37	0.44	7.48	6.37	0.45	7.48	6.37	0.46	7.48	6.37	0.46	7.48	6.37	0.46	7.48	6.37	0.46	7.48	6.37	0.45	7.48	6.37	0.46	7.48	6.37	0.46	7.48	6.37	0.46	7.48	6.37	0.46	7.48	6.37	0.46	7.48	6.37	0.46
31.4	11		6.00	6.00	0.32	6.00	6.00	0.33	6.00	6.00	0.34	6.00	6.00	0.35	6.00	6.00	0.37	6.00	6.00	0.38	6.00	6.00	0.38	6.00	6.00	0.38	6.00	6.00	0.39	6.00	6.00	0.39	6.00	6.00	0.39	6.00	6.00	0.39	6.00	6.00	0.39	6.00	6.00	0.39	6.00	6.00	0.39
44.9	13	20	7.48	7.25	0.42	7.48	7.25	0.42	7.48	7.25	0.44	7.48	7.25	0.45	7.48	7.25	0.46	7.48	7.25	0.46	7.48	7.25	0.46	7.48	7.25	0.46	7.48	7.25	0.45	7.48	7.25	0.46	7.48	7.25	0.46	7.48	7.25	0.46	7.48	7.25	0.46	7.48	7.25	0.46	7.48	7.25	0.46
52.0	14		8.22	7.18	0.46	8.22	7.18	0.47	8.22	7.18	0.48	8.22	7.18	0.49	8.22	7.18	0.51	8.22	7.18	0.50	8.22	7.18	0.50	8.22	7.18	0.49	8.22	7.18	0.49	8.22	7.18	0.49	8.22	7.18	0.49	8.22	7.18	0.49	8.22	7.18	0.49	8.22	7.18	0.49	8.22	7.18	0.49
22.9	11		6.00	6.00	0.32	6.00	6.00	0.33	6.00	6.00	0.34	6.00	6.00	0.35	6.00	6.00	0.37	6.00	6.00	0.38	6.00	6.00	0.38	6.00	6.00	0.39	6.00	6.00	0.39	6.00	6.00	0.39	6.00	6.00	0.39	6.00	6.00	0.39	6.00	6.00	0.39	6.00	6.00	0.39	6.00	6.00	0.39
34.8	13	22	7.48	7.48	0.42	7.48	7.48	0.42	7.48	7.48	0.44	7.48	7.48	0.45	7.48	7.48	0.46	7.48	7.48	0.46	7.48	7.48	0.46	7.48	7.48	0.46	7.48	7.48	0.45	7.48	7.48	0															

# Boosted capacity indoor unit with 12kW outdoor system

## RZAG125NV1 / RZAG125NY1

Indoor	Outdoor temperature [°C DB]																																									
	-20			-15			-10			-5			0			5			10			15			20			25			30			35			40					
	TC	SHC	CPI	TC	SHC	CPI	TC	SHC	CPI	TC	SHC	CPI	TC	SHC	CPI	TC	SHC	CPI	TC	SHC	CPI	TC	SHC	CPI	TC	SHC	CPI	TC	SHC	CPI	TC	SHC	CPI	TC	SHC	CPI	TC	SHC	CPI			
RH[%] °CWB °CDB																																										
41.8 11	7.49	7.49	0.32	7.49	7.49	0.33	7.49	7.49	0.34	7.49	7.49	0.35	7.49	7.49	0.36	7.49	7.49	0.37	7.49	7.49	0.38	7.49	7.49	0.38	7.49	7.49	0.38	10.25	9.60	0.98	9.71	9.28	1.08	9.17	8.94	1.18	8.69	8.60	1.27			
57.0 13	9.34	7.60	0.41	9.34	7.60	0.42	9.34	7.60	0.43	9.34	7.60	0.44	9.34	7.60	0.45	9.34	7.60	0.45	9.34	7.60	0.45	9.34	7.60	0.45	9.34	7.60	0.45	9.34	7.60	0.45	11.91	9.22	0.99	11.41	8.92	1.09	10.91	8.61	1.19	10.37	8.28	1.28
31.4 11	7.49	7.49	0.32	7.49	7.49	0.33	7.49	7.49	0.34	7.49	7.49	0.35	7.49	7.49	0.36	7.49	7.49	0.37	7.49	7.49	0.38	7.49	7.49	0.38	7.49	7.49	0.38	7.49	7.49	0.38	10.25	10.25	0.98	9.71	9.71	1.08	9.17	9.17	1.18	8.69	8.69	1.27
44.9 13	9.34	8.65	0.41	9.34	8.65	0.42	9.34	8.65	0.43	9.34	8.65	0.44	9.34	8.65	0.45	9.34	8.65	0.45	9.34	8.65	0.45	9.34	8.65	0.45	9.34	8.65	0.45	9.34	8.65	0.45	11.91	10.27	0.99	11.41	9.96	1.09	10.91	9.64	1.19	10.37	9.31	1.28
52.0 14	10.27	8.56	0.46	10.27	8.56	0.46	10.27	8.56	0.47	10.27	8.56	0.49	10.27	8.56	0.50	10.27	8.56	0.49	10.27	8.56	0.49	10.27	8.56	0.48	10.27	8.56	0.48	10.27	8.56	0.48	12.88	10.16	0.99	12.54	10.00	1.09	12.21	9.83	1.19	11.87	9.55	1.29
22.9 11	7.49	7.49	0.32	7.49	7.49	0.33	7.49	7.49	0.34	7.49	7.49	0.35	7.49	7.49	0.36	7.49	7.49	0.37	7.49	7.49	0.38	7.49	7.49	0.38	7.49	7.49	0.38	7.49	7.49	0.38	10.25	10.25	0.98	9.71	9.71	1.08	9.17	9.17	1.18	8.69	8.69	1.27
34.8 13	9.34	9.34	0.41	9.34	9.34	0.42	9.34	9.34	0.43	9.34	9.34	0.44	9.34	9.34	0.45	9.34	9.34	0.45	9.34	9.34	0.45	9.34	9.34	0.45	9.34	9.34	0.45	9.34	9.34	0.45	11.91	11.91	0.99	11.41	11.41	1.09	10.91	10.91	1.19	10.37	10.37	1.28
47.6 15	11.20	9.34	0.50	11.20	9.34	0.51	11.20	9.34	0.52	11.20	9.34	0.53	11.20	9.34	0.55	11.20	9.34	0.54	11.20	9.34	0.52	11.20	9.34	0.51	11.20	9.34	0.51	11.20	9.34	0.51	13.83	11.06	0.99	13.36	10.78	1.09	12.88	10.49	1.20	12.41	10.20	1.29
54.3 16	12.12	9.00	0.55	12.12	9.00	0.55	12.12	9.00	0.57	12.12	9.00	0.58	12.12	9.00	0.59	12.12	9.00	0.58	12.12	9.00	0.56	12.12	9.00	0.54	12.12	9.00	0.54	12.12	9.00	0.54	14.51	10.10	1.00	13.98	9.89	1.10	13.52	9.67	1.20	12.98	9.35	1.30
21.2 12	8.42	8.42	0.36	8.42	8.42	0.37	8.42	8.42	0.38	8.42	8.42	0.39	8.42	8.42	0.41	8.42	8.42	0.41	8.42	8.42	0.41	8.42	8.42	0.41	8.42	8.42	0.41	8.42	8.42	0.41	11.08	11.08	0.98	10.56	10.56	1.08	10.04	10.04	1.19	9.53	9.53	1.27
32.1 14	10.27	10.27	0.46	10.27	10.27	0.46	10.27	10.27	0.47	10.27	10.27	0.49	10.27	10.27	0.50	10.27	10.27	0.49	10.27	10.27	0.49	10.27	10.27	0.48	10.27	10.27	0.48	10.27	10.27	0.48	12.88	12.88	0.99	12.54	12.54	1.09	12.21	12.21	1.19	11.87	11.87	1.29
43.8 16	12.12	10.35	0.55	12.12	10.35	0.55	12.12	10.35	0.57	12.12	10.35	0.58	12.12	10.35	0.59	12.12	10.35	0.58	12.12	10.35	0.56	12.12	10.35	0.54	12.12	10.35	0.54	12.12	10.35	0.54	14.51	11.71	1.00	13.98	11.44	1.10	13.52	11.21	1.20	12.98	10.90	1.30
50.0 17	12.47	9.38	0.56	12.47	9.38	0.57	12.47	9.38	0.58	12.47	9.38	0.59	12.47	9.38	0.60	12.47	9.38	0.59	12.47	9.38	0.59	12.47	9.38	0.59	12.47	9.38	0.59	12.47	9.38	0.59	15.20	11.36	1.00	14.54	11.02	1.10	13.89	10.66	1.20	13.24	10.25	1.31
21.5 14	10.27	10.27	0.46	10.27	10.27	0.46	10.27	10.27	0.47	10.27	10.27	0.49	10.27	10.27	0.50	10.27	10.27	0.49	10.27	10.27	0.49	10.27	10.27	0.49	10.27	10.27	0.48	10.27	10.27	0.48	12.88	12.88	0.99	12.54	12.54	1.09	12.21	12.21	1.19	11.87	11.87	1.29
26.3 15	11.20	11.20	0.50	11.20	11.20	0.51	11.20	11.20	0.52	11.20	11.20	0.53	11.20	11.20	0.55	11.20	11.20	0.54	11.20	11.20	0.52	11.20	11.20	0.51	11.20	11.20	0.51	11.20	11.20	0.51	13.83	13.83	0.99	13.36	13.36	1.09	12.88	12.88	1.20	12.41	12.41	1.29
31.3 16	12.12	12.12	0.55	12.12	12.12	0.55	12.12	12.12	0.57	12.12	12.12	0.58	12.12	12.12	0.59	12.12	12.12	0.58	12.12	12.12	0.56	12.12	12.12	0.54	12.12	12.12	0.54	12.12	12.12	0.54	14.51	14.51	1.00	13.98	13.98	1.10	13.52	13.52	1.20	12.98	12.98	1.30

PAIR	FCAHG140H	FCAG140B	FVA140A	FHA140A	FBA140A
Cooling	3.09	3.07	3.17	3.05	2.99

TRIPLE	FCAG50Bx3	FHA50Ax3	FFA50Ax3	FDX50F3x	FBA50Ax3
Cooling	2.57	2.79	2.97	2.36	2.74

TWIN	FCAHG71Hx2	FCAG71Bx2	FHA71Ax2	FUA71Bx2	FAA71Ax2	FBA71Ax2
Cooling	2.57	2.79	2.68	2.69	2.88	2.64

DOUBLE TWIN	FCAG35Bx4	FHA35Ax4	FFA35Ax4	FDX35F4x	FBA35Ax4
Cooling	2.51	2.45	2.71	2.55	2.96

3D125186

# Boosted capacity indoor unit with 14kW outdoor system

## RZAG140NV1 / RZAG140NY1

Indoor	Outdoor temperature [°C DB]																																									
	-20			-15			-10			-5			0			5			10			15			20			25			30			35			40					
	TC	SHC	CPI	TC	SHC	CPI	TC	SHC	CPI	TC	SHC	CPI	TC	SHC	CPI	TC	SHC	CPI	TC	SHC	CPI	TC	SHC	CPI	TC	SHC	CPI	TC	SHC	CPI	TC	SHC	CPI	TC	SHC	CPI	TC	SHC	CPI			
RH[%] °CWB °CDB																																										
41.8 11	8.24	8.24	0.31	8.24	8.24	0.32	8.24	8.24	0.33	8.24	8.24	0.34	8.24	8.24	0.35	8.24	8.24	0.37	8.24	8.24	0.37	8.24	8.24	0.37	8.24	8.24	0.37	8.24	8.24	0.38	10.95	9.96	0.96	10.37	9.62	1.06	9.79	9.27	1.16	9.28	8.92	1.25
57.0 13	10.28	8.22	0.40	10.28	8.22	0.41	10.28	8.22	0.42	10.28	8.22	0.43	10.28	8.22	0.45	10.28	8.22	0.45	10.28	8.22	0.44	10.28	8.22	0.44	10.28	8.22	0.44	10.28	8.22	0.44	12.72	9.56	0.97	12.18	9.25	1.07	11.65	8.93	1.17	11.07	8.58	1.26
31.4 11	8.24	8.24	0.31	8.24	8.24	0.32	8.24	8.24	0.33	8.24	8.24	0.34	8.24	8.24	0.35	8.24	8.24	0.37	8.24	8.24	0.37	8.24	8.24	0.37	8.24	8.24	0.37	8.24	8.24	0.38	10.95	10.95	0.96	10.37	10.37	1.06	9.79	9.79	1.16	9.28	9.28	1.25
44.9 13	10.28	9.35	0.40	10.28	9.35	0.41	10.28	9.35	0.42	10.28	9.35	0.43	10.28	9.35	0.45	10.28	9.35	0.45	10.28	9.35	0.44	10.28	9.35	0.44	10.28	9.35	0.44	10.28	9.35	0.44	12.72	10.64	0.97	12.18	10.33	1.07	11.65	10.00	1.17	11.07	9.65	1.26
52.0 14	11.30	9.26	0.45	11.30	9.26	0.45	11.30	9.26	0.47	11.30	9.26	0.48	11.30	9.26	0.49	11.30	9.26	0.49	11.30	9.26	0.48	11.30	9.26	0.48	11.30	9.26	0.48	11.30	9.26	0.48	13.75	10.53	0.97	13.40	10.36	1.07	13.04	10.19	1.17	12.68	9.90	1.27
22.9 11	8.24	8.24	0.31	8.24	8.24	0.32	8.24	8.24	0.33	8.24	8.24	0.34	8.24	8.24	0.35	8.24	8.24	0.37	8.24	8.24	0.37	8.24	8.24	0.37	8.24	8.24	0.37	8.24	8.24	0.38	10.95	10.95	0.96	10.37	10.37	1.06	9.79	9.79	1.16	9.28	9.28	1.25
34.8 13	10.28	10.28	0.40	10.28	10.28	0.41	10.28	10.28	0.42	10.28	10.28	0.43	10.28	10.28	0.45	10.28	10.28	0.45	10.28	10.28	0.44	10.28	10.28	0.44	10.28	10.28	0.44	10.28	10.28	0.44	12.72	12.72	0.97	12.18	12.18	1.07	11.65	11.65	1.17	11.07	11.07	1.26
47.6 15	12.32	10.10	0.50	12.32	10.10	0.50	12.32	10.10	0.51	12.32	10.10	0.52	12.32	10.10	0.54	12.32	10.10	0.53	12.32	10.10	0.51	12.32	10.10	0.50	12.32	10.10	0.50	12.32	10.10	0.50	14.77	11.47	0.98	14.26	11.18	1.08	13.76	10.88	1.18	13.25	10.57	1.27
54.3 1																																										





# Sky Air Advance-series

Technology and comfort combined for commercial applications

- › High efficiency:
  - Energy labels up to A++ (cooling) / A+ (heating)
  - compressor offers substantial efficiency improvements
- › Very compact and easy to install
- › Replace existing systems with R-32 technology without needing to replace the piping
- › Guarantees operation in both heating and cooling mode down to -15°C
- › Refrigerant cooled PCB guarantees reliable cooling, as it is not influenced by ambient temperature.
- › Maximum piping length up to 50m, minimum piping length has no limitation
- › Outdoor units for pair, twin, triple, double twin application



RZASG100-140MV1\_MY1

## Pair, twin, triple and double twin application

capacity class	FCAG-B						FFA-A9			FDXM-F9			FBA-A(9)								
	35	50	60	71	100	125	140	35	50	60	35	50	60	35	50	60	71	100	125	140	
RZASG71MV1				P				2			2			2				P			
RZASG100MV1	RZASG100MY1	3	2			P		3	2		3	2		3	2				P		
RZASG125MV1	RZASG125MY1	4	3	2			P	4	3	2	4	3	2	4	3	2				P	
RZASG140MV1	RZASG140MY1	4	3		2			P	4	3				4	3						P

capacity class	FBA-A	FHA-A(9)						FUA-A			NEW FAA-B		FVA-A				FNA-A9						
		125	35	50	60	71	100	125	140	71	100	125	71	100	71	100	125	140	35	50	60		
RZASG71MV1			2			P				P			P		P						2		
RZASG100MV1	RZASG100MY1		3	2			P			P			P		P						3	2	
RZASG125MV1	RZASG125MY1	P	4	3	2			P				P						P			4	3	2
RZASG140MV1	RZASG140MY1		4	3		2			P	2			2		2					P	4	3	

P = Pair, 2 = Twin, 3 = Triple, 4 = Double twin

More details and final information can be found by scanning or clicking the QR codes.



RZASG-MV1



RZASG-MY1

Outdoor Unit		RZASG	71MV1	100MV1	125MV1	140MV1	100MY1	125MY1	140MY1	
Dimensions	Unit	HeightxWidthxDp	mm	770x900x320						990x940x320
Weight	Unit		kg	60	70	78	70	77	77	
Sound power level	Cooling		dBA	65	70	71	73	70	71	73
	Heating		dBA	-	71	73	-	71	73	
Sound pressure level	Cooling	Nom.	dBA	46	53	54	53	54	54	
	Heating	Nom.	dBA	47		57				
Operation range	Cooling	Ambient	Min.~Max.	°CDB						-15~46
	Heating	Ambient	Min.~Max.	°CWB						-15~-15.5
Refrigerant	Type/GWP			R-32/675						
	Charge		kg/TCO2Eq	2.45/1.65	2.60/1.76	2.90/1.96	2.60/1.76	2.90/1.96		
Piping connections	Liquid/Gas OD		mm	9.52/15.9						
	Piping length	OU - IU	Max.	m						50
		System	Equivalent	m						70
			Chargeless	m						30
		Additional refrigerant charge		kg/m	See installation manual					
Power supply	Phase/Frequency/Voltage		Hz/V	1~/50 /220-240				3~/50 /380-415		
Current - 50Hz	Maximum fuse amps (MFA)		A	20	25	32	16			

(1)According to ENER Lot 21 | Contains fluorinated greenhouse gases

# Sky Air Advance-series

Large Sky Air system for commercial applications in the most compact casing ever

- › Compact (870mm high) and lightweight single fan design makes the unit unobtrusive, saves space and is easy to install
- › Market-leading serviceability and handling, thanks to wide access area, 7-segment display and additional handle
- › Choosing for an R-32 product, reduces the environmental impact with 68% compared to R-410A, leads directly to lower energy consumption thanks to its high energy efficiency and has a lower refrigerant charge
- › Replace existing systems with R-32 technology without needing to replace the piping
- › Guarantees operation in heating mode down to -20°C
- › Refrigerant cooled PCB guarantees reliable cooling, as it is not influenced by ambient temperature.
- › Maximum piping length up to 100m
- › Maximum installation height difference up to 30m
- › Outdoor units for pair, twin, triple, double twin application
- › Combines with EKLN-A low sound enclosure



RZA-D

## Comfort cooling combination table

capacity class	FCAG-B					FFA-A9		FDXM-F9		FBA-A(9)					FHA-A(9)					FDA-A			FUA-A			FAA-B		FNA-A9	
	50	60	71	100	125	50	60	50	60	50	60	71	100	125	50	60	71	100	125	125	200	250	71	100	125	71	100	50	60
RZA200A	4	3	3	2		4	3	4	3	4	3	3	2		4	3	3	2			P		3	2		3	2	4	3
RZA250A		4			2		4		4				2			4			2	2		P			2				4

NEW

More details and final information can be found by scanning or clicking the QR codes.



Outdoor Unit		RZA		200D		250D	
Dimensions	Unit	HeightxWidthxDepth	mm	870x1,100x460			
Weight	Unit		kg	117			
Sound power level	Cooling		dBA	73		76	
	Heating		dBA	76		79	
Sound pressure level	Cooling	Nom.	dBA	53		57	
	Heating	Nom.	dBA	60		63	
Operation range	Cooling	Ambient	Min.~Max.	°CDB		-20~46	
	Heating	Ambient	Min.~Max.	°CWB		-20~15	
Refrigerant	Type/GWP			R-32/675			
	Charge		kg/TCO2Eq	5/3.38			
Piping connections	Liquid/Gas OD		mm	9.52/22.2			
	Piping	OU - IU	Max.	m			
	length	System	Chargeless	m			
	Additional refrigerant charge		kg/m	30			
Power supply	Phase/Frequency/Voltage		Hz/V	3~/50 /380-415			
Current - 50Hz	Maximum fuse amps (MFA)		A	20			

Contains fluorinated greenhouse gases



# Sky Air Active-series

Ideal solution for busy environments and small shops

- › High efficiency:
  - Energy labels up to A+ (cooling) / A (heating)
  - compressor offers substantial efficiency improvements
- › Choosing for an R-32 product, reduces the environmental impact with 68% compared to R-410A and leads directly to lower energy consumption thanks to its high energy efficiency
- › Very compact and easy to install
- › Replace existing systems with R-32 technology without needing to replace the piping



- › Guarantees operation in heating mode down to -15°C and in cooling mode down to -5°C
- › Refrigerant cooled PCB guarantees reliable cooling, as it is not influenced by ambient temperature.
- › Piping length up to 30m
- › Exclusively offered for pair applications



AZAS100-140MV1\_MY1

## Pair application

Capacity class	FCAG-B				FBA-A(9)				NEW FAA-B				ADEA-A		
	71	100	125	140	71	100	125	140	71	100	125	140	71	100	125
ARXM-R	P				P				P				P		
AZAS-MV1		P	P	P		P	P	P		P				P	P
AZAS-MY1		P	P	P		P	P	P		P					

P = pair application

More details and final information can be found by scanning or clicking the QR codes.



ARXM-R



AZAS-MV1



AZAS-MY1

Outdoor Unit				ARXM71R	AZAS100MV1	AZAS125MV1	AZAS140MV1	AZAS100MY1	AZAS125MY1	AZAS140MY1	
Dimensions	Unit	HeightxWidthxDepth	mm	734x954x401	990x940x320						
Weight	Unit		kg	49.0	70	78	70	77			
Sound power level	Cooling		dBA	-	70	71	73	70	71	73	
	Heating		dBA	-	71	73	-	71	73		
Sound pressure level	Cooling	Nom.	dBA	52.0	53	54	53	54			
	Heating	Nom.	dBA	52.0			57				
Operation range	Cooling	Ambient	Min.~Max.	°CDB	---		-5~46				
	Heating	Ambient	Min.~Max.	°CWB	---		-15~15.5				
Refrigerant	Type/GWP				R-32/675						
	Charge		kg/TCO2Eq	1.15/0.780	2.60/1.76	2.90/1.96	2.60/1.76	2.90/1.96			
Piping connections	Liquid/Gas OD		mm		9.52/15.9						
	Piping length	OU - IU	Max.	m		30					
		System	Equivalent	m	-	50					
			Chargeless	m	-	30					
	Additional refrigerant charge		kg/m	0.035 <small>(for piping length exceeding 10m)</small>	See installation manual						
	Level difference IU - OU	Max.	m	20.0	30.0						
Power supply	Phase/Frequency/Voltage		Hz/V		1~/50 /220-240				3~/50 /380-415		
Current - 50Hz	Maximum fuse amps (MFA)		A	-	25	32		16			

Contains fluorinated greenhouse gases



Wide range  
of R-32 rooftop units  
to cover your needs



### Made-To-Stock units (MTS)

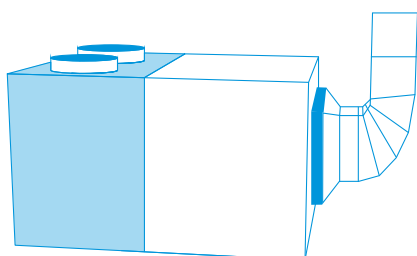

48 predefined units readily available from stock

- › Fast delivery
- › 3 versions: Base, 2 dampers and 3 dampers
  - › Thermodynamic heat recovery available on full FC3 range
- › Extended capacity up to 190 kW!
- › Comes with a wide range of standard integrated features

### Made-To-Order units (MTO)

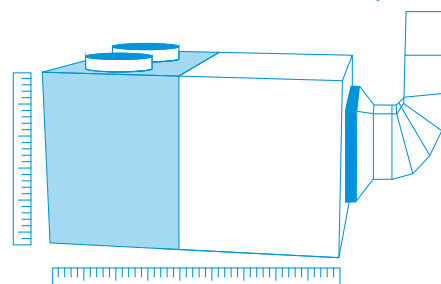

Fully customizable units for maximum flexibility

- › Almost infinite configuration possibilities thanks to wide choice of options
- › 4 versions: Base, 2 dampers, 3 dampers and 4 dampers
  - › Thermodynamic heat recovery available on full FC3 range
  - › Premium efficiency plate heat exchanger available on RS4 range
- › Extended capacity up to 190 kW!
- › Comes with a wide range of standard integrated features
- › Easy selection via selection software: [rooftop.daikin.eu](https://rooftop.daikin.eu)

## Products overview rooftops

Capacity class (kW)

Type	Model	MTS Product name	Refrigerant	Version	25	30	40	50	60	70	80	90	100	110	120	140	150	160	180	190	
Air cooled Heat pump	<b>Rooftop unit</b> With extensive base package for high installation flexibility and easy servicing - 'Plug and play' for easy installation - High efficiency - Field convertible return and supply air - Direct integration with Daikin or third party BMS - Factory pre-charged refrigerant	UATYA-BBAY1	<b>R-32</b>	MTS	•	•	•	•	•	•	•	•	•	•	•	•	•	•	•	•	
				MTO	•	•	•	•	•	•	•	•	•	•	•	•	•	•	•	•	•
	<b>Rooftop unit</b> 2 damper version with integrated fresh air - Free cooling with up to 100% fresh air intake - Comes with all Base model features	UATYA-BFC2Y1		MTS	•	•	•	•	•	•	•	•	•	•	•	•	•	•	•	•	•
				MTO	•	•	•	•	•	•	•	•	•	•	•	•	•	•	•	•	•
	<b>Rooftop unit</b> 3 damper version with integrated fresh air and extraction - Integrated extraction damper eliminates over-pressure - Thermodynamic heat recovery, recovering waste heat - Comes with all FC2 model features	UATYA-BFC3Y1	MTS	•	•	•	•	•	•	•	•	•	•	•	•	•	•	•	•	•	
			MTO	•	•	•	•	•	•	•	•	•	•	•	•	•	•	•	•	•	•
	<b>Rooftop unit</b> 4 damper version with integrated fresh air, extraction and plate heat exchanger - Premium efficiency plate heat exchanger, recovering waste heat - Comes with all FC3 model features	UATYA-BRS4*	MTS	•	•	•	•	•	•	•	•	•	•	•	•	•	•	•	•	•	
			MTO	•	•	•	•	•	•	•	•	•	•	•	•	•	•	•	•	•	•

\* Indicative model name. Correct model name to be retrieved from selection software.

## Standard integrated features on all Made-To-Stock and Made-To-Order units

### 1 R-32 refrigerant

- › Top sustainability thanks to the use of low GWP (675) refrigerant
- › Single component refrigerant, easy to re-use and recycle

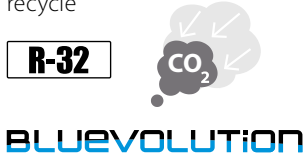

### 2 Inverter driven compressors

- › Great year-round seasonal efficiency
- › Available up to 120 kW models

### 3 Increased capacity range up to 190 kW!

- › More flexibility to tackle larger projects with a small footprint



### 4 25 mm double skinned panels

- › Ensuring long-lasting life and providing good thermal and sound insulation

### 5 Full color touch display

- › Intuitive to use
- › Better visualisation of unit parameters



### 6 Integrated connectivity

- › Direct integration into Daikin intelligent Touch Manager BMS (via BACNET protocol)
- › Easy integration in 3rd party BMS systems via Ethernet port (BACnet TCP/IP & Modbus TCP/IP) or 3-cable port (Modbus over RS485)



### 7 Selection software

- › Easy selection of the correction unit and options based on location conditions
- › Direct availability of technical drawings

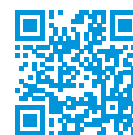

Select and configure your rooftop now!

[rooftop.daikin.eu](http://rooftop.daikin.eu)



## More standard integrated features

- › ISO Coarse 75% filter (G4) (standard for MTS only)
- › Standard clogged filter alarm
- › Flexible air delivery
- › Hydrophilic aluminum fins on indoor and outdoor unit side
- › Mesh coil guard on outdoor heat exchanger
- › Factory mounted drain pan with heater
- › Single operation voltage-free contact
- › Power supply connection safety through max/min voltage relay and reversed phase connection

Find out all about the R-32 rooftop range in this product webinar:



# 4 versions to choose from

## UATYA-BBAY1

### High installation flexibility and easy servicing

- › Easy to install 'plug and play' concept plus single installation configuration; no additional piping is required since indoor and outdoor sides are pre-connected
- › High efficiency and reliable scroll compressor
- › Factory pre-charged refrigerant ensures clean and efficient operation

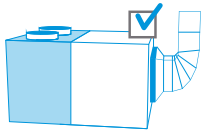

Made-To-Stock units (MTS)

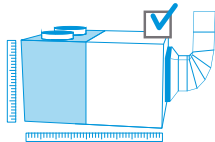

Made-To-Order units (MTO)

### HEATING OPERATION EXAMPLE

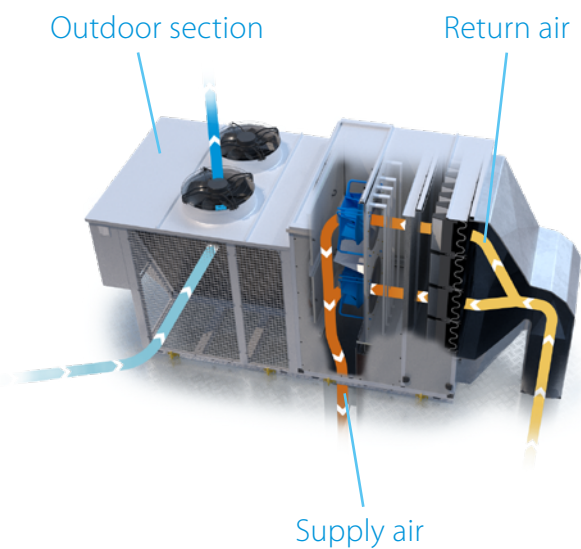

## UATYA-BFC2Y1

### 2 damper version, with integrated fresh air

- › Free cooling with up to 100% fresh air possible
  - › Improved air quality
  - › Energy saving using fresh outdoor air to cool the building
- › Includes all Base model features

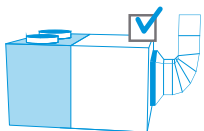

Made-To-Stock units (MTS)

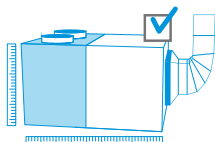

Made-To-Order units (MTO)

### HEATING OPERATION EXAMPLE

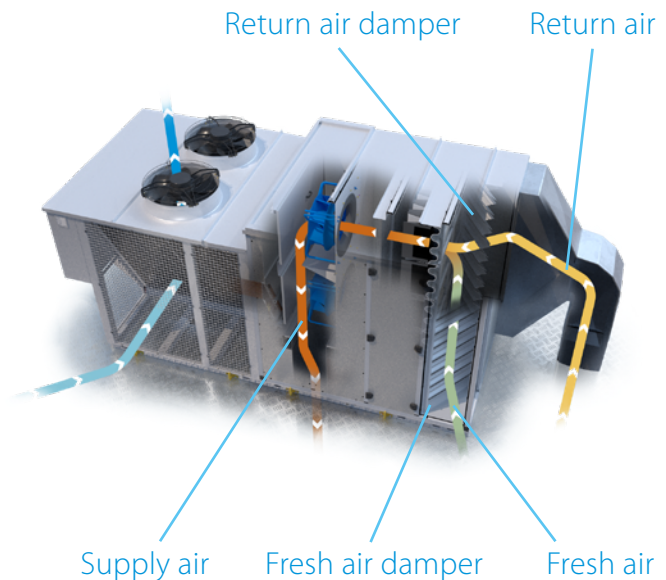

### 3 damper version, with integrated fresh air and extraction

- > Extraction damper integrated
  - > Eliminates excessive overpressure in the building
  - > Including high efficient extraction fan for optimum air circulation in larger buildings
- > Thermodynamic heat recovery
  - > Saves energy by recovering waste heat through the outdoor heat exchanger
  - > Available on all models
- > Includes all FC2 model features

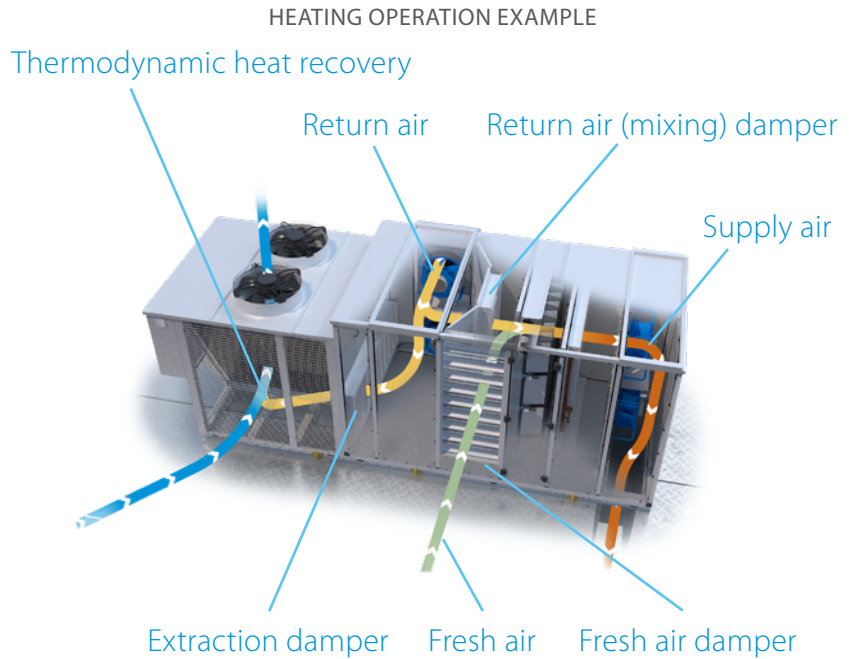
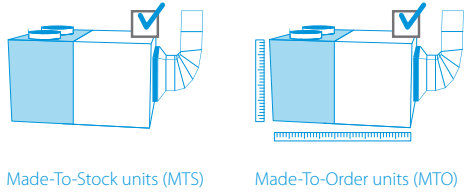

### UATYA-BRS4\*

### 4 damper version, with integrated fresh air, extraction and plate heat recovery

- > Premium efficiency counter flow plate heat exchanger
  - > Recovers up to 58% waste heat from the return air
  - > Available in 50% and 100% return air heat recovery
- > Bypass damper to allow plate heat exchange or free cooling
- > Additional thermodynamic heat recovery available up to 50kW models
- > Includes all FC3 model features
- > Only available as Made-To-Order model

\* Indicative model name. Correct model name to be retrieved from selection software.

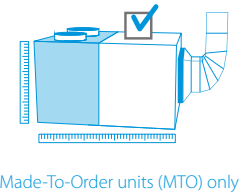

Made-To-Order units (MTO) only

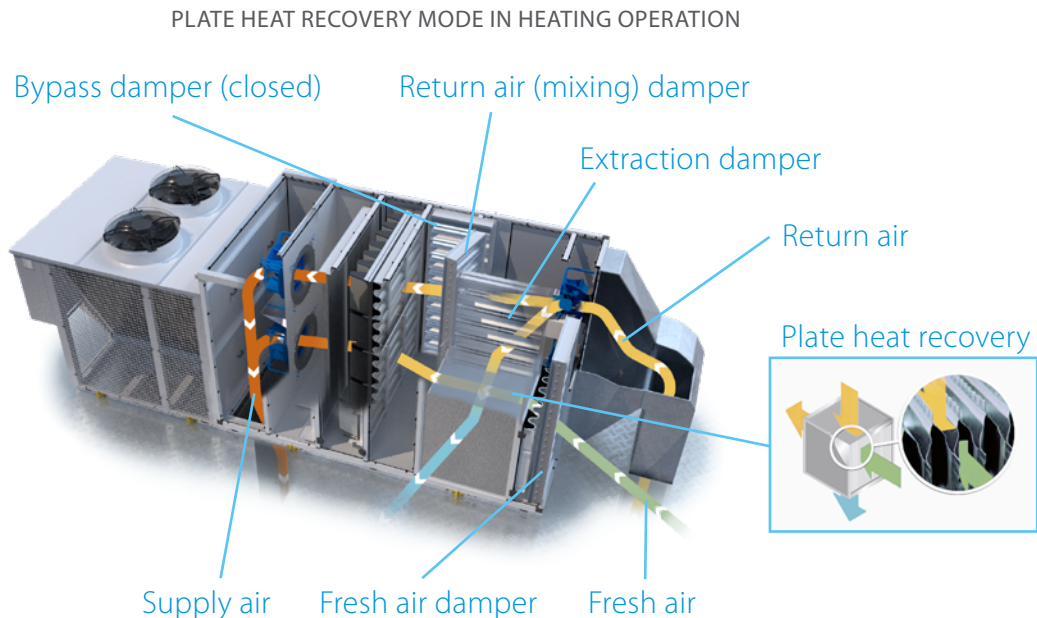

# Specifications Made-To-Stock units

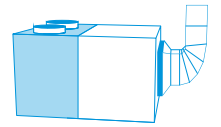

## UATYA-BBAY1

More details and final information can be found by scanning or clicking the QR codes.



UATYA-BBAY1

UATYA20-30BBAY1



Indoor Unit		UATYA-BBAY1																		
			25	30	40	50	60	70	80	90	100	110	120	140	150	160	180	190		
Cooling capacity	Nom.	kW	25.8	33.4	38.7	45.7	58.8	65.3	74.8	89.8	95.8	108.9	115.0	133.4	144.7	154.6	171.9	187.0		
Heating capacity	Nom.	kW	25.3	31.1	36.3	46.2	55.1	64.9	68.5	84.2	92.8	101.5	108.0	123.1	136.4	147.1	157.1	176.9		
EER			2.83	3.09	3.06	2.96	3.12	2.92	3.09	3.06	2.97	2.99	2.91	3.14	3.02	3.05	3.07	2.97		
COP			3.22	3.31	3.26	3.24	3.25	3.21	3.37	3.22	3.20	3.35	3.25	3.44	3.33	3.26	3.33	3.27		
Space cooling	Capacity	Pdesign	kW	25.8	33.4	38.7	45.7	58.8	65.3	74.8	89.8	95.8	108.9	115.0	133.4	144.7	154.6	171.9	187.0	
	SEER		%	4.62	4.89	5.39	5.26	5.50	4.53	5.56	5.47	5.17	5.29	5.15	4.38	4.26	4.27	4.15	4.08	
Space heating (Average climate)	Capacity	Pdesign	kW	25.3	31.1	36.3	46.2	55.1	64.9	68.5	84.2	92.8	101.5	108.0	123.1	136.4	147.1	157.1	176.9	
	SCOP/A		%	3.35	3.38	3.67	3.65	3.47	3.41	3.70	3.65	3.62	3.56	3.53	3.39	3.36	3.34	3.31	3.34	
Evaporator	Supply side	Air discharge direction	Bottom, Right, Left																	
		Fan	Air flow rate	m <sup>3</sup> /h	4,500	5,800	7,500	9,000	11,000	13,000	14,500	16,500	18,000	19,800	21,600	25,000	26,500	28,000	30,500	31,500
	Return side	Nominal ESP	Pa	300																
		Air intake direction	Rear																	
Fresh air	Standard	No																		
	Thermodynamic heat recovery	No																		
Condenser	Air flow rate	Cooling	m <sup>3</sup> /h	15,725	16,038	16,374	16,341	31,183	32,203	35,774	37,285	36,195	38,143	36,865	70,704	72,395	67,733	70,200	72,005	
	Refrigerant	GWP		675																
Dimensions	Unit	Charge	kg/TCO2Eq	70.4/725	10.0/6,750	12.0/8,100	15.0/10,125	18.0/12,150	23.0/15,525	24.0/16,200	28.0/18,900	30.0/20,250	36.0/24,300	38.0/25,650	46.0/31,050	50.0/33,750				
		Height	mm	1,924			2,374			1,924			2,250			2,374				
		Width	mm	2,250																
		Depth	mm	2,427					4,317					5,117						
Weight	Unit	kg	852	908	966	986	1,551	1,651	1,798	1,856	1,922	2,008	2,018	2,454	2,462	2,504	2,558	2,636		
Casing	Colour																			
Sound pressure level	Cooling	dB(A)	63.9	66.0	68.0	67.3	69.0	68.1	72.6	68.7	69.9	70.6	74.2	68.3	68.7	69.1	70.0			
Sound power level	Cooling	dB(A)	82.2	84.3	86.8	86.1	88.5	87.5	92.5	88.6	89.8	90.5	94.1	88.6	89.0	89.3	90.2			
Operation range	Cooling	Min. ~ Max.	°CDB							-10 ~ 48										
	Heating	Min. ~ Max.	°CWB							-15 ~ 26										
Power supply	Phase/Frequency/Voltage	Hz/V	3~/50/400																	
Current	Recommended fuses	A	25	40	50	63	80	100						160			200			

## UATYA-BFC2Y1

More details and final information can be found by scanning or clicking the QR codes.



UATYA-BFC2Y1

UATYA60-70BFC2Y1



Indoor Unit		UATYA-C2Y1																		
			25BF	30BF	40BF	50BF	60BF	70BF	80BF	90BF	100BF	110BF	120BF	140BF	150BF	160BF	180BF	190BF		
Cooling capacity	Nom.	kW	25.8	33.4	38.7	45.7	58.8	65.3	74.8	89.8	95.8	108.9	115.0	133.4	144.7	154.6	171.9	187.0		
	With 30% fresh air	kW	27.7	35.9	41.5	48.9	63.0	69.9	80.7	96.6	102.7	117.0	122.7	143.1	154.9	165.7	184.2	200.5		
Heating capacity	Nom.	kW	25.3	31.1	36.3	46.2	55.1	64.9	68.5	84.2	92.8	101.5	108.0	123.1	136.4	147.1	157.1	176.9		
	With 30% fresh air	kW	25.6	31.3	36.5	46.3	55.1	65.1	69.2	84.7	94.8	102.1	108.7	124.2	137.5	148.4	158.7	180.2		
EER	With 30% fresh air		2.97	3.26	3.21	3.10	3.28	3.06	3.26	3.24	3.13	3.03	3.29	3.16	3.19	3.21	3.10			
COP	With 30% fresh air		3.41	3.56	3.48	3.51	3.47	3.44	3.62	3.47	3.46	3.60	3.48	3.69	3.57	3.50	3.58	3.55		
Space cooling	Capacity	Pdesign	kW	25.8	33.4	38.7	45.7	58.8	65.3	74.8	89.8	95.8	108.9	115.0	133.4	144.7	154.6	171.9	187.0	
	SEER		%	4.62	4.89	5.39	5.26	5.50	4.53	5.56	5.47	5.17	5.29	5.15	4.38	4.26	4.27	4.15	4.08	
Space heating (Average climate)	Capacity	Pdesign	kW	25.3	31.1	36.3	46.2	55.1	64.9	68.5	84.2	92.8	101.5	108.0	123.1	136.4	147.1	157.1	176.9	
	SCOP/A		%	3.35	3.38	3.67	3.65	3.47	3.41	3.70	3.65	3.62	3.56	3.53	3.39	3.36	3.34	3.31	3.34	
Evaporator	Supply side	Air discharge direction	Frontal, Left																	
		Fan	Air flow rate	m <sup>3</sup> /h	4,500	5,800	7,500	9,000	11,000	13,000	14,500	16,500	18,000	19,800	21,600	25,000	26,500	28,000	30,500	31,500
	Return side	Nominal ESP	Pa	300																
		Air intake direction	Rear, Left, Right																	
Fresh air	Standard	Yes																		
	Ratio	Standard	%	30																
Condenser	Air flow rate	Cooling	m <sup>3</sup> /h	15,725	16,038	16,374	16,341	31,183	32,203	35,774	37,285	36,195	38,143	36,865	70,704	72,395	67,733	70,200	72,005	
		Refrigerant	GWP		675															
Dimensions	Unit	Charge	kg/TCO2Eq	70.4/725	10.0/6,750	12.0/8,100	15.0/10,125	18.0/12,150	23.0/15,525	24.0/16,200	28.0/18,900	30.0/20,250	36.0/24,300	38.0/25,650	46.0/31,050	50.0/33,750				
		Height	mm	1,924			2,374			1,924			2,250			2,374				
		Width	mm	2,250																
		Depth	mm	2,943					4,879					5,679						
Weight	Unit	kg	981	1,014	1,084	1,143	1,703	1,803	1,984	2,040	2,110	2,196	2,206	2,658	2,668	2,708	2,746	2,828		
Casing	Colour																			
Sound pressure level	Cooling	dB(A)	63.9	66.0	68.0	67.3	69.0	68.1	72.6	68.7	69.9	70.6	74.2	68.3	68.7	69.1	70.0			
Sound power level	Cooling	dB(A)	82.2	84.3	86.8	86.1	88.5	87.5	92.5	88.6	89.8	90.5	94.1	88.6	89.0	89.3	90.2			
Operation range	Cooling	Min. ~ Max.	°CDB							-10 ~ 48										
	Heating	Min. ~ Max.	°CWB							-15 ~ 26										
Power supply	Phase/Frequency/Voltage	Hz/V	3~/50/400																	
Current	Recommended fuses	A	25	40	50	63	80	100						160			200			

## UATYA-BFC3Y1

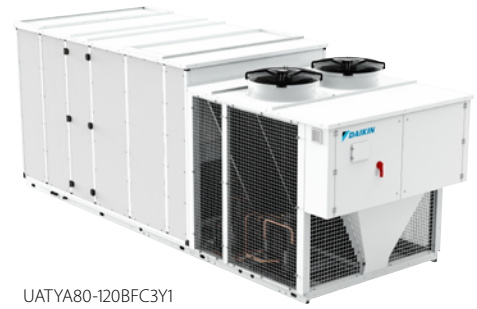

UATYA80-120BFC3Y1

More details and final information can be found by scanning or clicking the QR codes.



UATYA-BFC3Y1

Indoor Unit		UATYA-BFC3Y1	25	30	40	50	60	70	80	90	100	110	120	140	150	160	180	190	
Cooling capacity	Nom.	kW	25.8	33.4	38.7	45.7	58.8	65.3	74.8	89.8	95.8	108.9	115.0	133.4	144.7	154.6	171.9	187.0	
	With 30% fresh air	kW	27.8	36.1	42.5	49.6	63.7	70.5	81.3	96.8	104.3	118.0	124.5	145.6	156.8	168.3	186.5	204.4	
Heating capacity	Nom.	kW	25.3	31.1	36.3	46.2	55.1	64.9	68.5	84.2	92.8	101.5	108.0	123.1	136.4	147.1	157.1	176.9	
	With 30% fresh air	kW	26.0	32.4	38.3	47.7	57.1	68.6	71.6	87.2	97.9	107.0	112.3	132.0	147.5	160.0	173.5	191.6	
EER	With 30% fresh air		2.96	3.20	3.27	3.12	3.23	3.00	3.21	3.22	3.14	3.11	3.01	3.26	3.14	3.18	3.21	3.14	
	With 30% fresh air		3.38	3.48	3.51	3.46	3.40	3.39	3.56	3.45	3.42	3.57	3.40	3.62	3.57	3.49	3.63	3.50	
COP	With 30% fresh air		2.96	3.20	3.27	3.12	3.23	3.00	3.21	3.22	3.14	3.11	3.01	3.26	3.14	3.18	3.21	3.14	
	With 30% fresh air		3.38	3.48	3.51	3.46	3.40	3.39	3.56	3.45	3.42	3.57	3.40	3.62	3.57	3.49	3.63	3.50	
Space cooling	Capacity Pdesign	kW	25.8	33.4	38.7	45.7	58.8	65.3	74.8	89.8	95.8	108.9	115.0	133.4	144.7	154.6	171.9	187.0	
	SEER		4.62	4.89	5.39	5.26	5.50	4.53	5.56	5.47	5.17	5.29	5.15	4.38	4.26	4.27	4.15	4.08	
Space heating (Average climate)	Capacity Pdesign	kW	181.6	192.6	212.5	207.0	217.1	178.1	219.4	215.8	203.7	208.6	203.0	172.1	167.2	167.6	162.8	160.2	
	SCOP/A		3.35	3.38	3.67	3.65	3.47	3.41	3.70	3.65	3.62	3.56	3.53	3.39	3.36	3.34	3.31	3.34	
Evaporator	Supply side	Air discharge direction	Frontal, Left								Bottom, Right, Left, Frontal								
	Fan	Air flow rate	m <sup>3</sup> /h	4,500	5,800	7,500	9,000	11,000	13,000	14,500	16,500	18,000	19,800	21,600	25,000	26,500	28,000	30,500	31,500
Return side	Air intake direction	Rear				Right													
	Fan	Air flow rate	m <sup>3</sup> /min	4,500	5,800	7,500	9,000	11,000	13,000	14,500	16,500	18,000	19,800	21,600	25,000	26,500	28,000	30,500	31,500
Fresh air	Standard	Nominal ESP	300																
	Ratio	Standard	Yes																
Condenser	Air flow rate	Cooling	m <sup>3</sup> /h	15,725	16,038	16,374	16,341	31,183	32,203	35,774	37,285	36,195	38,143	36,865	70,704	72,395	67,733	70,200	72,005
	Refrigerant	Charge	kg/TCO2Eq	7.0/4,725	10.0/6,750	12.0/8,100	15.0/10,125	18.0/12,150	23.0/15,525	24.0/16,200	28.0/18,900	30.0/20,250	36.0/24,300	38.0/25,650	46.0/31,050	50.0/33,750			
Dimensions	Unit	Height	mm	1,924		2,374		1,924				2,374							
	Unit	Width	mm							2,250									
Weight	Unit	Depth	mm	3,514						6,317				7,117					
	Casing	Colour	kg	1,166	1,196	1,310	1,329	1,996	2,094	2,336	2,382	2,452	2,548	2,558	3,024	3,035	3,074	3,192	3,271
Sound pressure level	Cooling		dB(A)	63.9	66.0	68.0	67.3	69.0	68.1	72.6	68.7	69.9	70.6	74.2	68.3	68.7	69.1	70.0	
	Heating		dB(A)	82.2	84.3	86.8	86.1	88.5	87.5	92.5	88.6	89.8	90.5	94.1	88.6	89.0	89.3	90.2	
Operation range	Cooling	Min. ~ Max.	°CDB	-10 ~ 48															
	Heating	Min. ~ Max.	°CWB	-15 ~ 26															
Power supply	Phase/Frequency/Voltage	Hz/V	3~/50 /400																
Current	Recommended fuses	A	25	40	50	63	80	100				160				200			

## Specifications Made-To-Order units

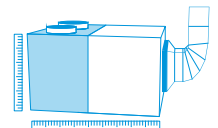

All naming in the tables above is valid for Made-To-Stock units only.

For specifications and configuration of Made-To-Order units refer to our selection software.



Select and configure your rooftop now!  
[rooftop.daikin.eu](http://rooftop.daikin.eu)



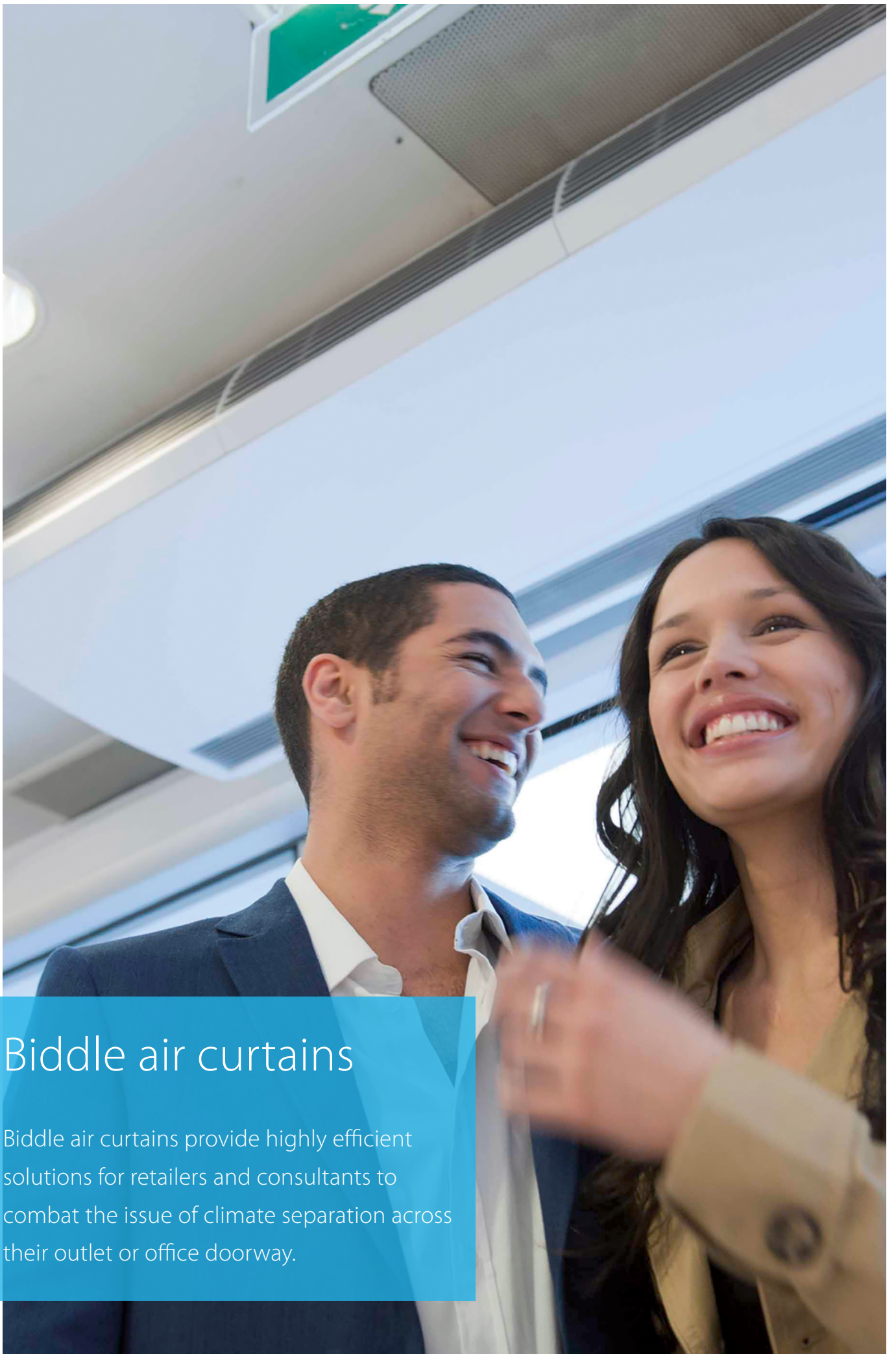

## Biddle air curtains

Biddle air curtains provide highly efficient solutions for retailers and consultants to combat the issue of climate separation across their outlet or office doorway.



## Biddle air curtain portfolio

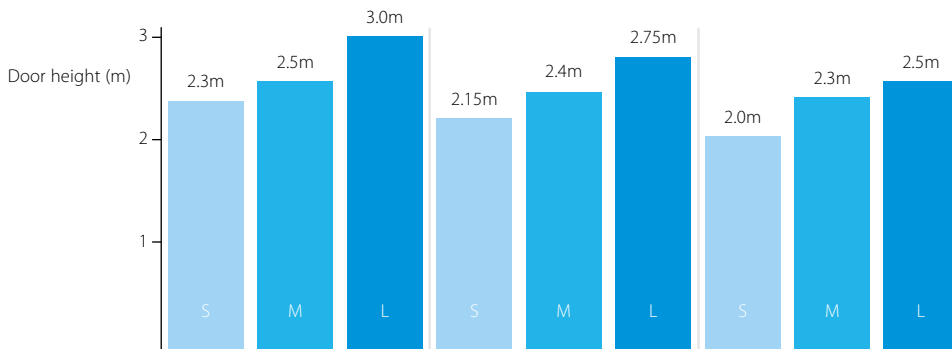

Installation condition

### Favourable



ex: covered shopping mall or revolving door entrance

### Normal

ex: little direct wind, no opposite open doors, building with ground floor only

### Unfavourable

ex: location at a corner or square, multiple floors and/or open stairwell

Type	Product name	Features	
Biddle standard air curtain free hanging	CYQ S/M/L-DK-F	- CYQ - Biddle air curtain for connection to ERQ - Connectable to ERQ heat pump - Cassette model (C): mounted into a false ceiling leaving only the decoration panel visible	
Biddle standard air curtain cassette	CYQ S/M/L-DK-C	- Free-hanging model (F): easy wall mounted installation - Recessed model (R): neatly concealed in the ceiling - A payback period of less than 1.5 years compared to installing an electric air curtain	
Biddle standard air curtain recessed	CYQ S/M/L-DK-R	- Easy and quick to install at reduced costs since no additional water systems, boilers and gas connections are required	

## Biddle air curtain nomenclature

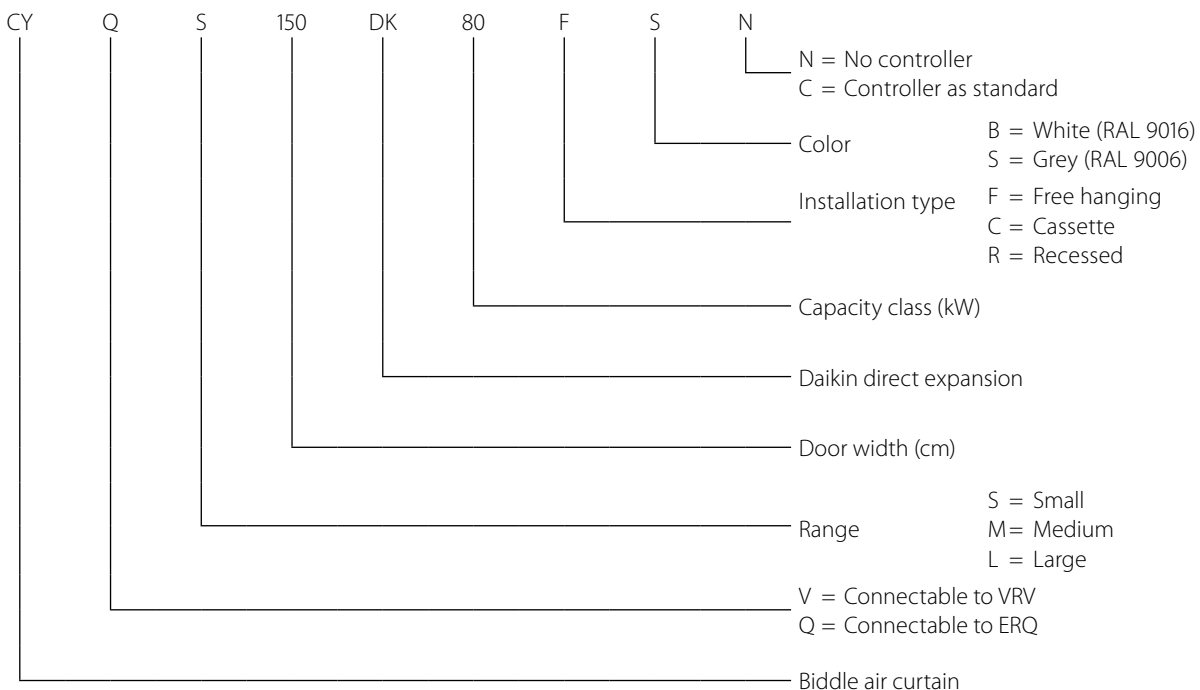

# Biddle air curtain for ERQ

- › Connectable to ERQ heat pump
- › ERQ is among the first DX systems suitable for connection to air curtains
- › Free-hanging model (F): easy wall mounted installation
- › Cassette model (C): mounted into a false ceiling leaving only the decoration panel visible
- › Recessed model (R): neatly concealed in the ceiling
- › A payback period of less than 1.5 years compared to installing an electric air curtain
- › Easy and quick to install at reduced costs since no additional water systems, boilers and gas connections are required
- › **PATENTED TECHNOLOGY:** Maximum energy efficiency stemming from almost zero down flow turbulence, optimised air flow and the application of advanced discharge rectifier technology
- › Around 85% air separation efficiency, greatly reducing both heat loss and required indoor unit heating capacity

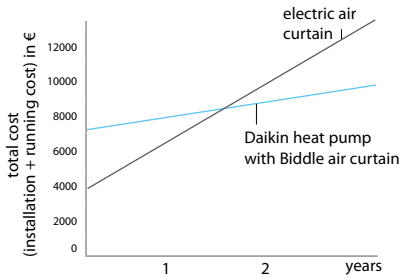

More details and final information can be found by scanning or clicking the QR codes.



## Outdoor units portfolio for connection to Biddle air curtains

System	Type	Product name	Condensing units		71	100	125	140	200	250
Air cooled	Heat pump	ERQ-AV1 <sup>1</sup> Condensing Units	- High efficiency - High comfort levels - Easy design and installation			●	●	●		
		ERQ-AW1 <sup>1</sup> Condensing Units	- Maximize installation flexibility by offering 4 types of control systems				●		●	●

1) Only use the condensing units in combinations with an air handling unit.

				Small			Medium			
				CYQS150DK80 *BN/*SN	CYQS200DK100 *BN/*SN	CYQS250DK140 *BN/*SN	CYQM100DK80 *BN/*SN	CYQM150DK80 *BN/*SN	CYQM200DK100 *BN/*SN	CYQM250DK140 *BN/*SN
Heating capacity	Speed 3		kW	9.0	11.6	16.2	9.2	11.0	13.4	19.9
Power input	Fan only	Nom.	kW	0.35	0.46	0.58	0.37	0.56	0.75	0.94
	Heating	Nom.	kW	0.35	0.46	0.58	0.37	0.56	0.75	0.94
Delta T	Speed 3		K	15			16	17	14	13
Casing	Colour			BN: RAL9010 / SN: RAL9006						
Dimensions	Unit	Height F/C/R	mm	270/270/270						
		Width F/C/R	mm	1,500/1,500/1,548	2,000/2,000/2,048	2,500/2,500/2,548	1,000/1,000/1,048	1,500/1,500/1,548	2,000/2,000/2,048	2,500/2,500/2,548
		Depth F/C/R	mm	590/821/561						
Required ceiling void >			mm	420						
Door height	Max.		m	2.3 (1) / 2.15 (2) / 2.0 (3)	2.3 (1) / 2.15 (2) / 2.0 (3)	2.3 (1) / 2.15 (2) / 2.0 (3)	2.5 (1) / 2.4 (2) / 2.3 (3)	2.5 (1) / 2.4 (2) / 2.3 (3)	2.5 (1) / 2.4 (2) / 2.3 (3)	2.5 (1) / 2.4 (2) / 2.3 (3)
Door width	Max.		m	1.5	2.0	2.5	1.0	1.5	2.0	2.5
Weight	Unit		kg	66	83	107	57	73	94	108
Fan-Air flow rate	Heating	Speed 3	m <sup>3</sup> /h	1,746	2,328	2,910	1,605	2,408	3,210	4,013
Sound pressure level	Heating	Speed 3	dB(A)	49	50	51	50	51	53	54
Refrigerant	Type / GWP			R-410A / 2,087.5						
Piping connections	Liquid/OD/Gas/OD		mm	9.52/16.0		9.52/19.0	9.52/16.0			9.52/19.0
Required accessories (should be ordered separately)				Daikin wired remote control (BRC1H51(9)W/S/K / BRC1E53A/B/C / BRC1D52)						
Power supply	Voltage		V	230						

				Large			
				CYQL100DK125*BN/*SN	CYQL150DK200*BN/*SN	CYQL200DK250*BN/*SN	CYQL250DK250*BN/*SN
Heating capacity	Speed 3		kW	15.6	23.3	29.4	31.1
Power input	Fan only	Nom.	kW	0.75	1.13	1.50	1.88
	Heating	Nom.	kW	0.75	1.13	1.50	1.88
Delta T	Speed 3		K	15			
Casing	Colour			BN: RAL9010 / SN: RAL9006			
Dimensions	Unit	Height F/C/R	mm	370/370/370			
		Width F/C/R	mm	1,000/1,000/1,048	1,500/1,500/1,548	2,000/2,000/2,048	2,500/2,500/2,548
		Depth F/C/R	mm	774/1,105/745			
Required ceiling void >			mm	520			
Door height	Max.		m	3.0 (1) / 2.75 (2) / 2.5 (3)	3.0 (1) / 2.75 (2) / 2.5 (3)	3.0 (1) / 2.75 (2) / 2.5 (3)	3.0 (1) / 2.75 (2) / 2.5 (3)
Door width	Max.		m	1.0	1.5	2.0	2.5
Weight	Unit		kg	76	100	126	157
Fan-Air flow rate	Heating	Speed 3	m <sup>3</sup> /h	3,100	4,650	6,200	7,750
Sound pressure level	Heating	Speed 3	dB(A)	53	54	56	57
Refrigerant	Type / GWP			R-410A / 2,087.5			
Piping connections	Liquid/OD/Gas/OD		mm	9.52/16.0	9.52/19.0	9.52/22.0	
Required accessories (should be ordered separately)				Daikin wired remote control (BRC1H51(9)W/S/K / BRC1E53A/B/C / BRC1D52)			
Power supply	Voltage		V	230			

(1) Favorable conditions: covered shopping mall or revolving door entrance (2) Normal conditions: little direct wind, no opposite open doors, building with ground floor only (3) Unfavorable conditions: location at a corner or square, multiple floors and/or open stairway



# Commercial Ventilation & Air Purification

## Why choose Daikin Ventilation & Air Purification? 92

ERV / HRV - Energy/Heat recovery ventilation units 96

ALB-LBS/RBS - Modular L Smart 96

Heater for Modular L Smart 97

VAM-FC9/J8 98

Heater for VAM 99

Daikin air handling units with DX connection 100

Advantages 100

Overview of VRV & ERQ condensing units 101

Control possibilities 102

ERQ specifications 103

Integration in third party AHU 104

Expansion valves & Control boxes 104

**NEW** BR00000554/676/678 - AAF Astropure 2000 106

**NEW** Indoor Environmental Sensor 108

# 5 reasons why Daikin's ventilation range is unique in the market

## 1 Market leading controls & connectivity

- › Interlock of ventilation and air conditioning system
  - Control ERV/HRV and air conditioning from the same controller
  - Aligns the operation mode between the systems to save energy
- › Easy integration in the total solution
  - Online control and monitoring via the Daikin Cloud Service
  - Full portfolio integration in the intelligent Touch Manager, Daikin's cost-effective mini BMS
- › User-friendly controller with premium design
  - Intuitive touch button control

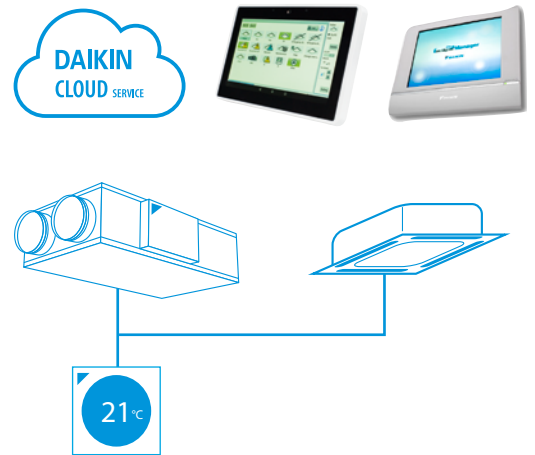

Madoka



reddot award 2018 winner

## 2 Unique installation benefits

- › Integrates seamlessly in the Daikin total solution, ensuring a single point of contact
- › Total fresh air solution with Daikin supplying both the VAM/Modular L Smart and the electrical heater
- › Daikin AHU and condensing unit connect Plug & Play thanks to same pipe diameters, factory mounted controls, expansion valves, etc.





### 3 High energy efficiency

- › Energy recovery of up to 92%, reducing running costs
- › Free nighttime cooling using fresh outside air
- › Inverter driven centrifugal fans
- › ErP compliant



### 4 Best comfort

- › Wide range of units to control fresh air and humidity
- › Wide range of optional filters to suit the application available up to ePM<sub>1</sub> 80% (F9)
- › Special paper heat exchanger recovers heat and moisture from extract air to warm up and humidify fresh air to comfortable levels (VAM, VKM)



### 5 Top reliability

- › Most extensive testing before new units leave the factory
- › Widest support network and after sales service
- › All spare parts available in Europe



## Did you know?

CO<sub>2</sub> levels and ventilation rates all have significant, independent impacts on cognitive function:

#### COGNITIVE FUNCTION SCORES ...



**+ 61%**  
IN GREEN BUILDING  
CONDITIONS



**+ 101%**  
IN ENHANCED  
GREEN BUILDING CONDITIONS

# Widest range of DX integrated ventilation on the market

Daikin offers a variety of solutions from small energy recovery ventilation to large-scale air handling units for the provision of fresh air ventilation to homes, or commercial premises.

## Ventilation solutions

Daikin offers state-of-the-art ventilation solutions that can easily be integrated into any project:

- › **Unique portfolio** within DX manufacturers
- › High-quality solutions complying with the **highest Daikin quality standards**
- › **Seamless integration** of all products to provide the best indoor climate
- › All Daikin products connected to a single controller for **complete control** of the HVAC system.

## Energy Recovery Ventilation

Our energy recovery units **recover sensible energy** (Modular L Pro / Modular L Smart) or **total (sensible + latent) energy** (VAM/EKVDX/VKM-GBM), substantially reducing the load on the air conditioning system up to 40%.

## Ventilation with DX connection - Control over fresh air temperature

Daikin offers a range of inverter condensing units to be used in combination with Daikin AHUs for ultimate control over the fresh air. There are 4 control possibilities when **combining AHU and Daikin outdoor units** hence offering all the required flexibility for any installation. Indoor units can be combined to the same outdoor unit to reduce the installation costs. For **false-ceiling installations** where space is a constraint, the VKM can fit perfectly to deliver fresh air at a comfortable temperature and it has an optional humidification element.

## Indoor Environment Quality Components

- › **Ventilation:** Ensures the provision of fresh and clean air
- › **Energy recovery:** Delivers energy savings by transferring heat and moisture between airflows thus helping to bring supply air to the required indoor conditions for temperature and humidity
- › **Air processing:** Delivers the required conditioned air to optimize the energy efficiency of indoor HVAC equipment
- › **Humidification:** Ensures the desired moisture level in the conditioned space
- › **Filtration:** Ensures clean and healthy air by filtering out pollen, dust, odors and other contaminants that are harmful to our health

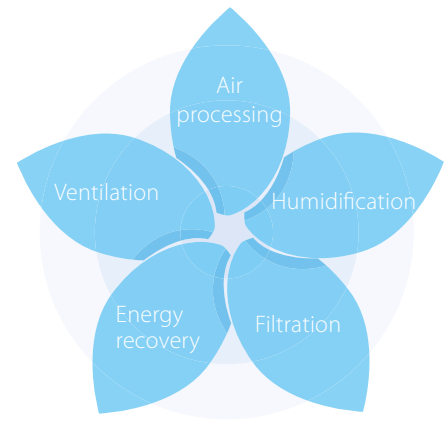

## Fresh air portfolio



## Outdoor units portfolio for connection to air handling units

System	Type	Product name	Condensing units	71	100	125	140	200	250
Air cooled	Heat pump	ERQ-AV1 <sup>1</sup> Condensing Units	- High efficiency - High comfort levels		●	●	●		
		ERQ-AW1 <sup>1</sup> Condensing Units	- Easy design and installation - Maximize installation flexibility by offering 4 types of control systems			●		●	●

1) Only use the condensing units in combinations with an air handling unit.

# Modular L Smart

Premium efficiency heat recovery unit

## Highlights

- › Connects Plug&Play into the Sky Air and VRV control network
- › Easy installation and commissioning
- › Internal pre-filter stage (up to ePM<sub>1</sub> 50% (F7) + ePM<sub>1</sub> 80% (F9)) making the unit reach highest indoor air quality requirements.
- › Wide air flow coverage from 150m<sup>3</sup>/h to 3,400m<sup>3</sup>/h
- › Exceeding ErP 2018 requirements
- › Best choice when compactness is needed (only 280 mm height up to 550 m<sup>3</sup>/h)
- › 50 mm double skin panel (120 kg/m<sup>3</sup>) for a maximum sound and thermal insulation

## EC centrifugal fan

- › Maximum ESP available 600 Pa (depending on model sizes and airflow)
- › Inverter driven with IE4 premium efficiency motor
- › High-efficient blade profiling
- › Reduced energy consumption
- › Optimized SFP (Specific Fan Power) for an efficient unit operation

## Heat exchanger

- › Premium quality counter flow plate heat exchanger
- › Up to 91% of the thermal energy recovered
- › High grade aluminum allowing optimum corrosion protection



Right drain connection (ALB-RBS)



Left drain connection (ALB-LBS)

More details and final information can be found by scanning or clicking the QR codes.



ALB-LBS



ALB-RBS

## Technical details

D-AHU Modular L Smart			ALB02*BS	ALB03*BS	ALB04*BS	ALB05*BS	ALB06*BS	ALB07*BS
Airflow		m <sup>3</sup> /h	300	600	1,200	1,600	2,300	3,000
Heat exchanger thermal efficiency (1)		%	86		87			86
External static pressure	Nom.	Pa			100			
Current	Nom.	A	0.61	1.35	2.26	2.83	4.39	6.22
Power input	Nom.	kW	0.14	0.31	0.52	0.65	1.01	1.43
SFPv (2)		kW/m <sup>3</sup> /s	1.25	1.52	1.3	1.35	1.35	1.51
Electrical supply	Phase	ph	1					
	Frequency	Hz	50/60					
	Voltage	V	220/240 Vac					
Main unit dimensions	Width	mm	920	1,100	1,600		2,000	
	Height	mm	280	350	415		500	
	Length	mm	1,660	1,800	2,000			
Rectangular duct flange	Width	mm	250	400	500		700	
	Height	mm	150	200	300		400	
Weight unit		kg	125	180	270	280	355	360

(1) Winter design condition: Outdoor: -5°C, 90% Indoor: 22°C, 50% | (2) SFPv is a parameter that quantifies the fan efficiency (the lower it is the better will be). This reduces if airflow decreases.



## Electrical heater for Modular L Smart

- › Total solution for fresh air with Daikin supply of both Modular L Smart and electrical heaters
- › Increase comfort in low outdoor temperature thanks to the heated outdoor air
- › Integrated electrical heater concept (no additional accessories required)
- › Standard dual flow and temperature sensor
- › Heater only consumes what is required to pre-heat to the desired minimum fresh air temperature; thus saving energy



More details and final information can be found by scanning or clicking the QR codes.



Electrical heater for Modular L Smart (ALD)	02HEFB	03HEFB	05HEFB	07HEFB
Capacity kW	1,5	3	7,5	15
Connectable Modular L Smart size	02	03	04, 05	06, 07
Supply voltage	230V,1ph		400V,3ph	
Output current (maximum) (A)	6,6	13,1	10,9	21,7
Temperature sensor	15k ohms at -20 °C 10k ohms at +10 °C	16k ohms at -20 °C 10k ohms at +10 °C	17k ohms at -20 °C 10k ohms at +10 °C	18k ohms at -20 °C 10k ohms at +10 °C
Temperature control range	- 20 °C to 10 °C			
Control fuse	Mini Circuit Breaker 6 A			
LED indicators	Yellow = Airflow fault Red = Heat ON			
Mounting holes	Depends on duct size			
Maximum ambient adjacent to terminal box	30°C (during operation)			
Auto high temperature cutout	75°C Pre-set			
Manual reset high temperature cutout	120°C Pre-set			
Width (mm)	470	620	720	920
Depth (mm)	370	370	370	370
Height (mm)	193	243	343	443

# Energy recovery ventilation

## Ventilation with heat recovery as standard

- › Thinnest High Efficiency Enthalpy Heat Exchanger in the market (J-series)
- › Energy saving ventilation using indoor heating, cooling and moisture recovery
- › Free cooling possible when outdoor temperature is below indoor temperature (eg. during nighttime)
- › Prevent energy losses from over-ventilation while improving indoor air quality with optional CO<sub>2</sub> sensor (J-series)
- › Possibility to change ESP via wired remote control allows optimisation of the supply air volume (J - series)
- › Can be used as stand alone or integrated in the Sky Air or VRV system
- › Wide range of units: air flow rate from 150 up to 2,000 m<sup>3</sup>/h
- › Shorter installation time thanks to easy adjustment of nominal air flow rate, so less need for dampers compared with traditional installation
- › No drain piping needed
- › Can operate in over- and under pressure
- › Total solution for fresh air with Daikin supply of both VAM / VKM and electrical heaters
- NEW** › VAM-J8 series are connectable to EKVDX DX coil for air processing

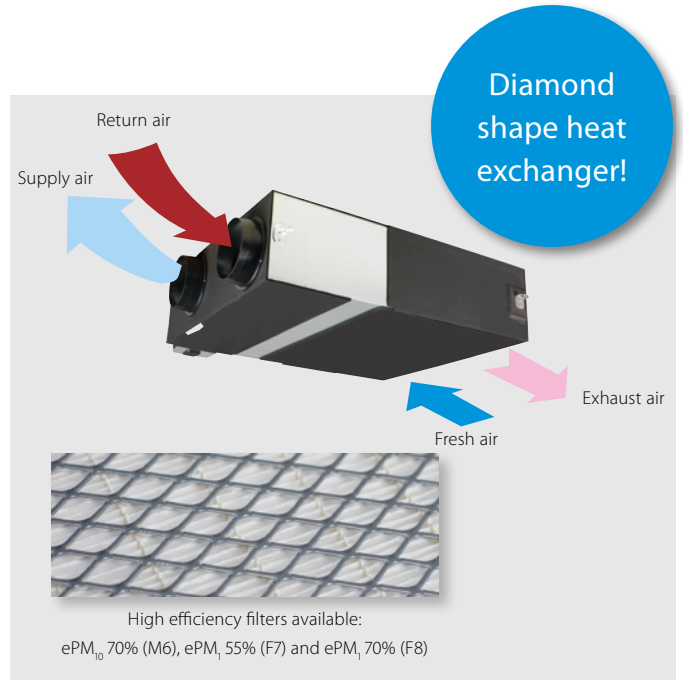

More details and final information can be found by scanning or clicking the QR codes.



VAM-FC9



VAM-J8

Ventilation		VAM/VAM	150FC9	250FC9	350J8	500J8	650J8	800J8	1000J8	1500J8	2000J8		
Power input - 50Hz	Heat exchange mode	Nom. Ultra high/High/Low	kW	0.132/0.111/0.058	0.161/0.079/0.064	0.097/0.070/0.039	0.164/0.113/0.054	0.247/0.173/0.081	0.303/0.212/0.103	0.416/0.307/0.137	0.548/0.384/0.191	0.833/0.614/0.273	
	Bypass mode	Nom. Ultra high/High/Low	kW	0.132/0.111/0.058	0.161/0.079/0.064	0.085/0.061/0.031	0.148/0.100/0.045	0.195/0.131/0.059	0.289/0.194/0.086	0.417/0.300/0.119	0.525/0.350/0.156	0.835/0.600/0.239	
Temperature exchange efficiency - 50Hz	Ultra high/High/Low		%	77.0(1)/72.0(2)/78.3(1)/72.3(2)/82.8(1)/73.2(2)	74.9(1)/69.5(2)/76.0(1)/70.0(2)/80.1(1)/72.0(2)	85.1/86.7/90.1	80.0/82.5/87.6	84.3/86.4/90.5	82.5/84.2/87.7	79.6/81.8/86.1	83.2/84.8/88.1	79.6/81.8/86.1	
	Cooling	Ultra high/High/Low	%	60.3(1)/61.9(1)/67.3(1)	60.3(1)/61.2(1)/64.5(1)	65.2/67.9/74.6	59.2/61.8/69.5	59.2/63.8/73.1	67.7/70.7/76.8	62.6/66.4/74.0	68.9/71.8/77.5	62.6/66.4/74.0	
Enthalpy exchange efficiency - 50Hz	Heating	Ultra high/High/Low	%	66.6(1)/67.9(1)/72.4(1)	66.6(1)/67.4(1)/70.7(1)	75.5/77.6/82.0	69.0/72.2/78.7	73.1/76.3/82.7	72.8/75.3/80.2	68.6/71.7/77.9	73.8/76.1/80.8	68.6/71.7/77.9	
	Operation mode: Heat exchange mode, bypass mode, fresh-up mode												
Heat exchange system: Air to air cross flow total heat (sensible + latent heat) exchange													
Heat exchange element: Specially processed non-flammable paper													
Dimensions	Unit	HeightxWidthxDepth	mm	285x776x525		301x1,113x886		368x1,354x920		368x1,354x1,172		731x1,354x1,172	
Weight	Unit		kg	24.0		46.5		61.5		79.0		157	
Casing: Galvanised steel plate													
Fan	Air flow rate - 50Hz	Heat exchange mode	Ultra high/High/Low	m <sup>3</sup> /h	150 /140 /105	250 /230 /155	350 (1)/300 (1)/200 (1)	500 (1)/425 (1)/275 (1)	650 (1)/550 (1)/350 (1)	800 (1)/680 (1)/440 (1)	1,000 (1)/850 (1)/550 (1)	1,500 (1)/1,275 (1)/825 (1)	2,000 (1)/1,700 (1)/1,100 (1)
		Bypass mode	Ultra high/High/Low	m <sup>3</sup> /h	150 /140 /105	250 /230 /155	350 (1)/300 (1)/200 (1)	500 (1)/425 (1)/275 (1)	650 (1)/550 (1)/350 (1)	800 (1)/680 (1)/440 (1)	1,000 (1)/850 (1)/550 (1)	1,500 (1)/1,275 (1)/825 (1)	2,000 (1)/1,700 (1)/1,100 (1)
	External static pressure - 50Hz	Ultra high/High/Low	Pa	90 /87/40	70 /63/25	90 (1)/70.0 /50.0 (1)							
Air filter: Multidirectional fibrous fleeces													
Sound pressure level - 50Hz	Heat exchange mode	Ultra high/High/Low	dBA	27.0/26.0/20.5	28.0/26.0/21.0	34.5 (1)/32.0 (1)/29.0 (1)	37.5 (1)/35.0 (1)/30.5 (1)	39.0 (1)/36.0 (1)/31.0 (1)	39.0 (1)/36.0 (1)/30.5 (1)	42.0 (1)/38.5 (1)/32.5 (1)	42.0 (1)/39.0 (1)/33.5 (1)	45.0 (1)/41.5 (1)/36.0 (1)	
	Bypass mode	Ultra high/High/Low	dBA	27.0/26.5/20.5	28.0/27.0/21.0	34.5 (1)/32.0 (1)/28.0 (1)	38.0 (1)/35.0 (1)/29.5 (1)	38.0 (1)/34.5 (1)/30.5 (1)	40.0 (1)/36.5 (1)/30.5 (1)	42.5 (1)/40.0 (1)/32.5 (1)	42.0 (1)/39.0 (1)/32.5 (1)	45.0 (1)/41.0 (1)/35.0 (1)	
Operation range: Around unit °CDB -													
Connection duct diameter: mm 100 150 200 250 2x250													
Power supply	Phase/Frequency/Voltage		Hz/V	1~ ; 50/60 ; 220-240/220									
Current	Maximum fuse amps (MFA)		A	15.0				16.0					
Specific energy consumption (SEC)	Cold climate		kWh/(m <sup>2</sup> .a)	-56.0 (5)	-60.5 (5)	-							
	Average climate		kWh/(m <sup>2</sup> .a)	-22.1 (5)	-27.0 (5)	-							
	Warm climate		kWh/(m <sup>2</sup> .a)	-0.100 (5)	-5.30 (5)	-							
SEC class: D / See note 5 B / See note 5													
Maximum flow rate at 100 Pa ESP	Flow rate		m <sup>3</sup> /h	130	207	-							
	Electric power input		W	129	160	-							
Sound power level (Lwa)			dB	40	43	51	54	58	61	62	65		
Annual electricity consumption			kWh/a	18.9 (5)	13.6 (5)	-							
Annual heating saved	Cold climate		kWh/a	41.0 (5)	40.6 (5)	-							
	Average climate		kWh/a	80.2 (5)	79.4 (5)	-							
	Warm climate		kWh/a	18.5 (5)	18.4 (5)	-							

(1)Measured according to JIS B 8628 | (2)Measured at reference flow rate according to EN13141-7 | (5) At reference flow rate in accordance with commission regulation (EU) No 1254/2014

# Electrical heater for VAM

- › Total solution for fresh air with Daikin supply of both VAM and electrical heaters
- › Increased comfort in low outdoor temperature thanks to the heated outdoor air
- › Integrated electrical heater concept (no additional accessories required)
- › Standard dual flow and temperature sensor
- › Flexible setting with adjustable setpoint
- › Increased safety with 2 cut-outs: manual & automatic



More details and final information can be found by scanning or clicking the QR codes.



	GSIEKA	10009	15018	20024	25030	35530 <sup>(1)</sup>
Capacity	kW	0.9	1.8	2.4	3.0	3.0
Duct diameter	mm	100	150	200	250	355
Connectable VAM		VAM150FC9	VAM250FC9	VAM350,500J8	VAM650J8, VAM800J8, VAM1000J8	VAM1500J8, VAM2000J8

		GSIEKA10009	GSIEKA15018	GSIEKA20024	GSIEKA25030	GSIEKA35530
Dimensions	Height	mm	171	221	271	321
	Depth	mm	100	150	200	250
	Width	mm	370	370	370	370
Minimum air velocity / airflow		m/s	1.5			
		m³/h	45	100	170	265
Power supply		1~230 VAC/50Hz				
Nominal current	A	4.1	8.2	10.9	13.1	13.1
Heating power	kW	0.9	1.8	2.4	3.0	3.0
Connection duct diameter	mm	100	150	200	250	355
Operation range	Min.	°C	-40°C			
	Max.	°C	40°C			
	Rel. Humidity	%	90%			
Temperature sensor		10 kΩ at +25°C / TJ-K10K				
Temperature sensor range		- 30°C to 105°C				
Temperature set point range		- 10°C to 50°C				
LED indicators	LED 1	flashing every 5 seconds	heater is starting up			
		flashing every second	air flow detected, heating allowed			
	OFF	no power supply or no flow				
	ON	problem with duct temperature sensor, set point potentiometer or PTC airflow sensor				
	LED 2	OFF	heater is not operation			
		ON	heater is operating			
Ambient temperature adjacent to controller		0°C to +50°C				
Auto high temperature cut-out		50°C				
Manual reset high temperature cut-out		100°C				

# Daikin's air handling units solutions

You will find your match

## Why choose Daikin air handling units with a DX connection?



### Simplifying business

The unique total solution approach by Daikin helps businesses to propose better cross-pillar solutions, to increase their success ratio by providing unmatched product combinations to the end-user and to simplify the life of installers by supplying high-quality products coming from the same manufacturer. Contrary to other manufacturers, Daikin does not use OEM products in its AHU with DX offer. Many competitors are either offering OEM DX outdoor units or OEM AHU which create additional problems when warranties or faults arise. **Having a single interface for your business makes Daikin the right choice.**

### One-stop shop

Daikin is the only global manufacturer in the market **capable of offering a true Plug & Play solution** where Daikin AHUs manufactured by Daikin Applied Europe and certified by Eurovent, offer off-the-shelf compatibility with Daikin's unique VRV outdoor unit range for the best performance in the market. This unique integration of cross-pillar products under the same umbrella, gives the customer both peace-of-mind and added value when promoting a total solution approach.

### Complete range of possibilities

Thanks to the **most complete offer in the market**, Daikin has the solution for all types of commercial applications requiring fresh air. Daikin provides ventilation solutions based on AHU from 2,500 m<sup>3</sup>/h up to 140,000 m<sup>3</sup>/h either with natural heat recovery or more advanced ventilation solutions where a VRV outdoor unit can be connected to the Daikin AHU for ultimate climate control. The harmonized control, between the VRV outdoor unit and the AHU, offer outstanding reliable operation of the system when connected to an iTM.

## Advantages

- › Unique manufacturer offering a complete range
- › Plug & Play solution
- › Direct iTM compatibility

## Why use VRV and ERQ condensing units for connection to air handling units?

### High Efficiency

Daikin heat pumps are renowned for their high energy efficiency. Integrating the AHU with a high efficiency heat pump system lower the carbon footprint of the building.

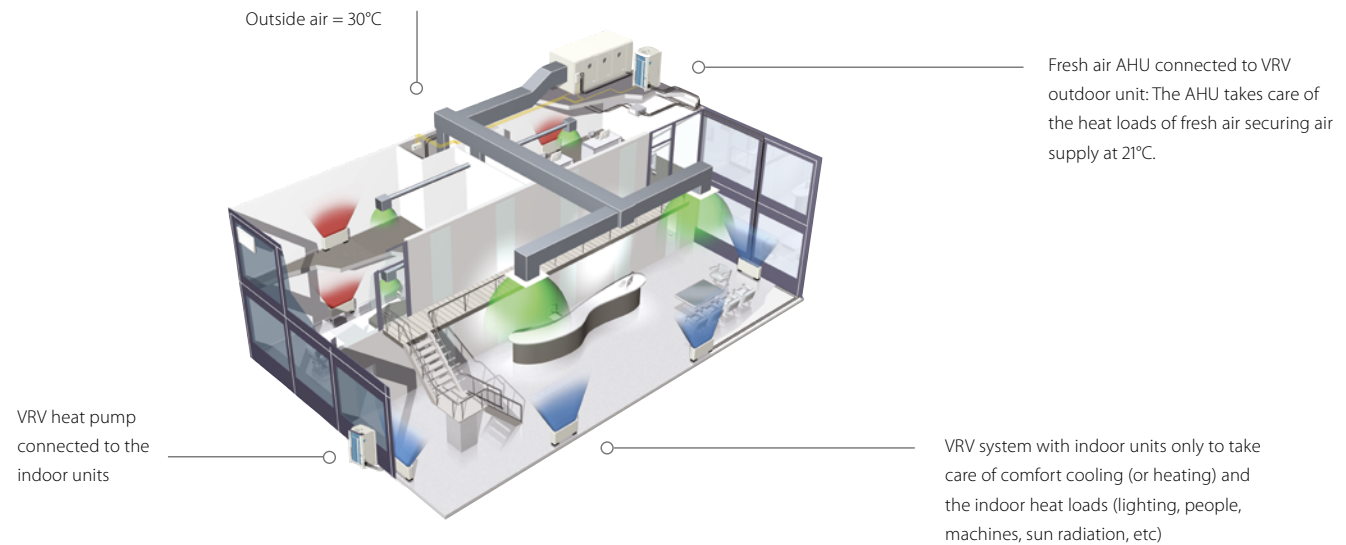

### Fast response to changing loads resulting in high comfort levels

Daikin ERQ and VRV units respond rapidly to fluctuations in supply air temperature, resulting in a steady indoor temperature and resultant high comfort levels for the end user. The ultimate is the VRV range which improves comfort even more by offering continuous heating, also during defrost.

### Easy Design and Installation

The system is easy to design and install since no additional water systems such as boilers, tanks and gas connections etc. are required. This also reduces both the total system investment and running cost.

### Daikin Fresh air package

- › Plug & Play connection between VRV/ERQ and the entire D-AHU modular range.
- › Factory fitted and welded DX coil control and expansion valve kits.

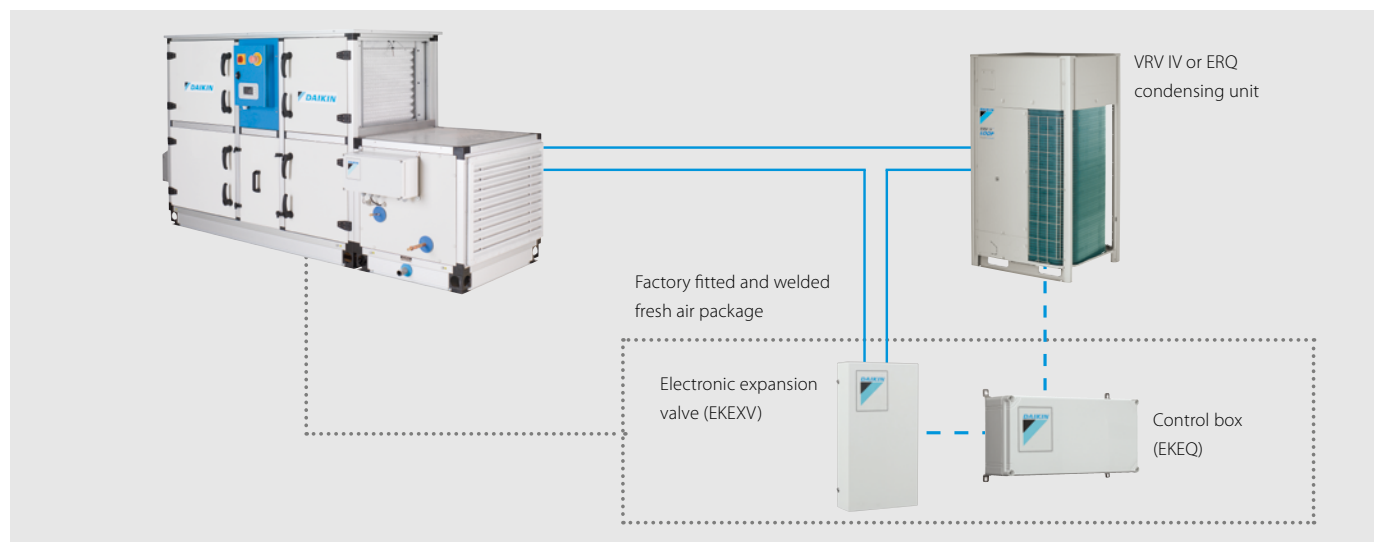

# In order to maximise installation flexibility, 4 types of control systems are offered

**W control:** Off the shelf control of air temperature (discharge temperature, suction temperature, room temperature) via any DDC controller, easy to setup

**X control:** Precise control of air temperature (discharge temperature, suction temperature, room temperature) requiring a preprogrammed DDC controller (for special applications)

**Z control:** Control of air temperature (suction temperature, room temperature) via Daikin control (no DDC controller needed)

**Y control:** Control of refrigerant ( $T_e/T_c$ ) temperature via Daikin control (no DDC controller needed)

## 1. W control ( $T_d/T_s/T_{room}$ control):

### Air temperature control via DDC controller

Room temperature is controlled as a function of the air handling unit suction or discharge air (customer selection). The DDC controller is translating the temperature difference between set point and air suction temperature (or air discharge temperature or room temperature) into a proportional 0-10V signal which is transferred to the Daikin control box (EKEQFCBA). This voltage modulates the capacity requirements of the outdoor unit.

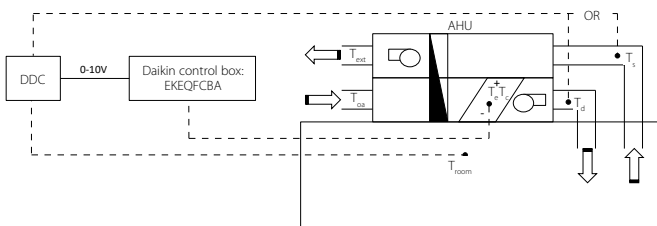

## 2. X control ( $T_d/T_s/T_{room}$ control):

### Precise air temperature control via DDC controller

Room temperature is controlled as a function of the air handling unit suction or discharge air (customer selection). The DDC controller is translating the temperature difference between set point and air suction temperature (or air discharge temperature or room temperature) into a reference voltage (0-10V) which is transferred to the Daikin control box (EKEQFCBA). This reference voltage will be used as the main input value for the compressor frequency control.

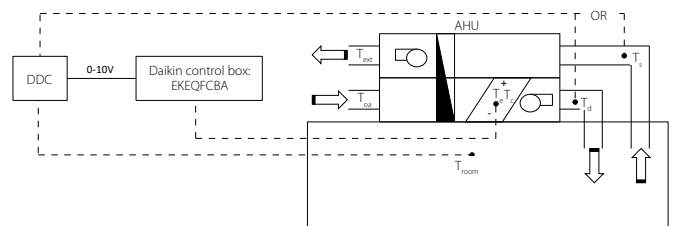

## 3. Y control ( $T_e/T_c$ control):

### By fixed evaporating /condensing temperature

A fixed target evaporating or condensing temperature can be set by the customer. In this case, room temperature is only indirectly controlled. A Daikin wired remote control (BRC1\* - optional) have to be connected for initial set-up but not required for operation.

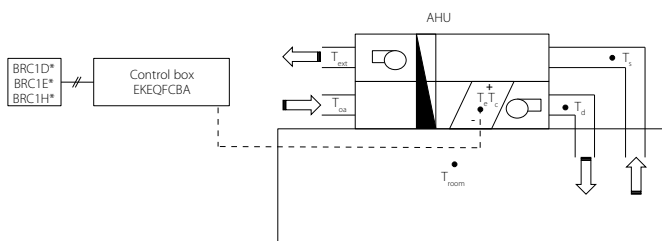

## 4. Z control ( $T_d/T_{room}$ control):

### Control your AHU just like a VRV indoor unit (100% recirculation air application)

Allows the possibility to control the AHU just like a VRV indoor unit. Meaning temperature control will be focused on return air temperature from the room into the AHU. Requires BRC1\* for operation. The only control that allows the combination of other indoor units to the AHU at the same time.

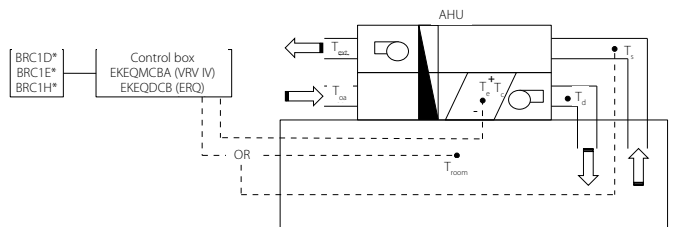

$T_d$  = Discharge (supply) air temperature     $T_s$  = Suction (return) air temperature     $T_{oa}$  = Outdoor air temperature     $T_{room}$  = Room air temperature  
 $T_{ext}$  = Extraction air temperature     $T_e$  = Evaporating temperature     $T_c$  = Condensing temperature

	Option kit	Features
Possibility W	EKEQFCBA	Off-the-shelf DDC controller that requires no pre-configuration
Possibility X		Pre-configured DDC controller required
Possibility Y		Using fixed evaporating temperature, no set point can be set using remote control
Possibility Z	EKEQDCB EKFQMCBA*	Using Daikin infrared remote control BRC1* Temperature control using air suction temperature or room temperature (via remote sensor)

\* EKEQMCB (for 'multi' application)

# ERQ - for smaller capacities (from 100 to 250 class)

## A basic fresh air solution for pair application

- › Inverter controlled units
- › Heat pump
- › R-410A
- › Wide range of expansion valve kits available
- › Perfect for the Daikin Modular air handling unit

The "Daikin Fresh Air Package" provides a complete Plug & Play Solution including AHU, ERQ or VRV Condensing Unit and all unit control (EKEQ, EKEX, DDC controller) factory mounted and configured. The easiest solution with only one point of contact.

More details and final information can be found by scanning or clicking the QR codes.



ERQ-AV1



ERQ-AW1



ERQ-AW1

Ventilation				ERQ	100AV1	125AV1	140AV1
Capacity range			HP	4	5	6	
Cooling capacity	Nom.		kW	11.2	14.0	15.5	
Heating capacity	Nom.		kW	12.5	16.0	18.0	
Power input	Cooling	Nom.	kW	2.81	3.51	4.53	
	Heating	Nom.	kW	2.74	3.86	4.57	
EER					3.99		3.42
COP				4.56	4.15		3.94
Dimensions	Unit	HeightxWidthxDepth	mm		1,345x900x320		
Weight	Unit		kg		120		
Casing	Material				Painted galvanized steel plate		
Fan-Air flow rate	Cooling	Nom.	m <sup>3</sup> /min		106		
	Heating	Nom.	m <sup>3</sup> /min	102		105	
Sound power level	Cooling	Nom.	dB(A)	66	67		69
Sound pressure level	Cooling	Nom.	dB(A)	50	51		53
	Heating	Nom.	dB(A)	52	53		55
Operation range	Cooling	Min./Max.	°CDB		-5/46		
	Heating	Min./Max.	°CWB		-20/15.5		
	On coil temperature	Heating/Min./Cooling/Max.	°CDB		10/35		
Refrigerant	Type				R-410A		
	Charge		kg		4.0		
			TCO <sub>2</sub> eq		8.4		
	GWP				2,087.5		
Piping connections	Control				Expansion valve (electronic type)		
	Liquid	OD	mm		9.52		
	Gas	OD	mm		15.9		19.1
Drain	OD	mm			26x3		
Power supply	Phase/Frequency/Voltage		Hz/V		1N~/50/220-240		
Current	Maximum fuse amps (MFA)		A		32.0		

Ventilation				ERQ	125AW1	200AW1	250AW1
Capacity range			HP	5	8	10	
Cooling capacity	Nom.		kW	14.0	22.4	28.0	
Heating capacity	Nom.		kW	16.0	25.0	31.5	
Power input	Cooling	Nom.	kW	3.52	5.22	7.42	
	Heating	Nom.	kW	4.00	5.56	7.70	
EER				3.98	4.29	3.77	
COP				4.00	4.50	4.09	
Dimensions	Unit	HeightxWidthxDepth	mm	1,680x635x765		1,680x930x765	
Weight	Unit		kg	159	187	240	
Casing	Material				Painted galvanized steel plate		
Fan-Air flow rate	Cooling	Nom.	m <sup>3</sup> /min	95	171	185	
	Heating	Nom.	m <sup>3</sup> /min	95	171	185	
Sound power level	Nom.		dB(A)	72		78	
Sound pressure level	Nom.		dB(A)	54	57		58
Operation range	Cooling	Min./Max.	°CDB		-5/43		
	Heating	Min./Max.	°CWB		-20/15		
	On coil temperature	Heating/Min./Cooling/Max.	°CDB		10/35		
Refrigerant	Type				R-410A		
	Charge		kg	6.2	7.7	8.4	
			TCO <sub>2</sub> eq	12.9	16.1	17.5	
	GWP				2,087.5		
Piping connections	Control				Electronic expansion valve		
	Liquid	OD	mm		9.52		
	Gas	OD	mm	15.9	19.1	22.2	
Power supply	Phase/Frequency/Voltage		Hz/V		3N~/50/400		
Current	Maximum fuse amps (MFA)		A	16		25	

# Integration of ERQ and VRV in third party air handling units

a wide range of expansion valve kits and control boxes

## Combination table

		Control box			Expansion valve kit										Mixed connection with VRV indoor units		
		EKEQDCB	EKEQFCBA	EKEQMCBA	EKEXV50	EKEXV63	EKEXV80	EKEXV100	EKEXV125	EKEXV140	EKEXV200	EKEXV250	EKEXV400	EKEXV500			
		Z control	W,X,Y control	Z control	-	-	-	-	-	-	-	-	-	-	-	-	-
1-phase	ERQ100	P (1)	P	-	-	P	P	P	P	-	-	-	-	-	-	-	-
	ERQ125	P (1)	P	-	-	P	P	P	P	P	-	-	-	-	-	-	-
	ERQ140	P (1)	P	-	-	-	P	P	P	P	-	-	-	-	-	-	-
3-phase	ERQ125	P (1)	P	-	-	P	P	P	P	P	-	-	-	-	-	-	-
	ERQ200	P (1)	P	-	-	-	-	P	P	P	P	P	P	-	-	-	-
	ERQ250	P (1)	P	-	-	-	-	-	-	P	P	P	P	-	-	-	-
VRV IV H/P VRV IV C-series VRV IV high ambient VRV IV W-series VRV IV S-series		-	P	P (1) / n2 (1)										Possible (not mandatory)			
VRV IV i-series		-	-	n1										Mandatory (no hydrobox)			
VRV IV H/R		-	-	n1										Mandatory (no hydrobox)			

- P (pair application) - One or more outdoor units connected to an (interlaced) coil of one AHU. To determine exact configuration please refer to the engineering data book.
- n1 (only mix application) - Combination of (multiple) AHU(s) and VRV DX indoor(s) is mandatory. To determine the exact configuration please refer to the engineering data book.
- n2 (mix or multi application) - Combination of (multiple) AHU(s) with (mix application) or without (multi application) VRV DX indoor(s). To determine the exact configuration please refer to the engineering data book.
- Control box EKEQFA can be connected to some types of VRV IV outdoor units (with a maximum of 3 boxes per unit). Do not combine EKEQFA control boxes with VRV DX indoor units, RA indoor units or hydroboxes
- (1) No interlaced coil possible with Z control

## Capacity table

### Cooling

EKEXV Class	Allowed heat exchanger capacity (kW)			Allowed heat exchanger volume (dm <sup>3</sup> )	
	Minimum	Standard	Maximum	Minimum	Maximum
50	5.0	5.6	6.2	1.33	1.65
63	6.3	7.1	7.8	1.66	2.08
80	7.9	9.0	9.9	2.09	2.64
100	10.0	11.2	12.3	2.65	3.30
125	12.4	14.0	15.4	3.31	4.12
140	15.5	16.0	17.6	4.13	4.62
200	17.7	22.4	24.6	4.63	6.60
250	24.7	28.0	30.8	6.61	8.25
400	35.4	45.0	49.5	9.26	13.2
500	49.6	56.0	61.6	13.2	16.5

Saturated evaporating temperature: 6°C  
Air temperature: 27°C DB / 19°C WB

### Heating

EKEXV Class	Allowed heat exchanger capacity (kW)			Allowed heat exchanger volume (dm <sup>3</sup> )	
	Minimum	Standard	Maximum	Minimum	Maximum
50	5.6	6.3	7.0	1.33	1.65
63	7.1	8.0	8.8	1.66	2.08
80	8.9	10.0	11.1	2.09	2.64
100	11.2	12.5	13.8	2.65	3.30
125	13.9	16.0	17.3	3.31	4.12
140	17.4	18.0	19.8	4.13	4.62
200	19.9	25.0	27.7	4.63	6.60
250	27.8	31.5	34.7	6.61	8.25
400	39.8	50.0	55.0	9.26	13.2
500	55.1	63.0	69.3	13.2	16.5

Saturated condensing temperature: 46°C  
Air temperature: 20°C DB

## EKEXV - Expansion valve kit for air handling applications

Ventilation		EKEXV	50	63	80	100	125	140	200	250	400	500
Dimensions	Unit	mm	401x215x78									
Weight	Unit	kg	2.9									
Sound pressure level	Nom.	dB(A)	45									
Operation range	On coil temperature	Heating Min. °CDB	10 (1)									
		Cooling Max. °CDB	35 (2)									
Refrigerant	Type / GWP	R-410A / 2.087,5										
Piping connections	Liquid OD	mm	6.35	9.52							12.7	15.9

(1) The temperature of the air entering the coil in heating mode can be reduced to -5°CDB. Contact your local dealer for more information. (2) 45% Relative humidity.

## EKEQ - Control box for air handling applications

Ventilation		EKEQ	FCBA	DCB	MCBA
Application			Pair	Pair	Pair/Multi/Mix
Outdoor unit			ERQ / VRV	ERQ	VRV
Dimensions	Unit	mm	132x400x200		
Weight	Unit	kg	3.9	3.6	
Power supply	Phase/Frequency/Voltage	Hz/V	1~/50/230		

The combination of EKEQFCBA and ERQ is in pair application. The EKEQFCBA can be connected to some type of VRV IV outdoor units with a maximum of 3 control boxes. The combination with DX indoor units, hydroboxes, RA outdoor units, ... is not allowed. Refer to the combination table drawing of the outdoor unit for details.







VRV IV+ in mix application with VRV indoor units and Modular R AHU



## Astropure 2000, Air Purifier for Commercial Applications

### Plug & play, mobile recirculation unit with high efficiency filtration – for better indoor air quality in commercial spaces

- › For areas where additional, extra high, filtration performance is needed.
- › Airflow rate up to 2,000 m<sup>3</sup>/h
- › HEPA H14 filter in accordance with EN1822
- › Pre-filter options up to ISO Coarse 70%
- › Optional UV germicidal irradiation (UVGI)
- › Insulated double-wall construction provides whisper-quiet operation down to 35 dB(A)
- › Easy installation, operation, and maintenance in a totally self-contained system
- › For commercial areas up to 200m<sup>2</sup>



### Models

Model	BR0000554		BR0000749		BR0000676		BR0000751		BR0000678		BR0000752	
Plug type	EU	UK	EU	UK	EU	UK	EU	UK	EU	UK	EU	UK
HEPA Filter (H14)		✓				✓				✓		
LCD Screen						✓				✓		
Activ. Carbon (Gas phase) pre-filter						✓				✓		
UV light										✓		

### Applications:



Schools and Universities



Commercial Buildings



Healthcare



Hospitality



Shops and Shopping malls

### Providing high-efficiency 2-stage filtration

#### Standard prefilter

All units are delivered with a prefilter, increasing filter life and protecting the installed HEPA filter

#### RedPleat - 4531002424

- › Delivered with BR0000554/749
- › ISO 16890: ISO coarse 70%
- › Available with Antimicrobial treated media (RedPleat ULTRA)



#### RedPleat Carb - 4139002424

- › Delivered with BR0000676/751/678/752
- › ISO 16890: ISO coarse 65%
- › Effectively removes offensive odors



#### Main filter

The HEPA filter features eFRM filtration media which combines ultra-high efficiency and particulate loading to remove 99.99% of dust, pollen, mold, bacteria, viruses, and any airborne particle with a size of 0.3 microns or greater.

#### AstroCel III - 1493299990

- › H14 filtration efficiency according EN 1822
- › V-shaped filter configuration, combined with microglass media, delivers higher flow and the lowest possible pressure drop vs traditional box style HEPA filters
- › Compatible with Discrete Particle Counter (DPC) and photometric test methods as access and instrumentation allow



# Astropure 2000, Air Purifier for Commercial Applications

Plug & play, mobile recirculation unit with high efficiency filtration – for better indoor air quality in commercial spaces

- › CAirflow rate up to 2000 m<sup>3</sup>/h
- › HEPA H14 filter in accordance with EN1822
- › Optional touch sensitive LCD Display (BR00000676/678/751/751)
- › Optional UV-C light module (BR00000678/752)
- › Insulated double-wall construction provides whisper-quiet operation
- › Activated carbon filter
- › Sliding tray design provides easy access and servicing of filters
- › Designed with internal variable fan speed (electronically commutated) to meet specific application requirements
- › Suitable for in-room use or sheltered outdoor installation
- › CE-compliance, VDI 6022 guided design



More details and final information can be found by scanning or clicking the QR codes.



BR00000554



BR00000676



BR00000678

Ventilation				BR00000554	BR00000749	BR00000676	BR00000751	BR00000678	BR00000752	
	Plug type			EU	UK	EU	UK	EU	UK	
Features	HEPA Filter (H14)				✓		✓		✓	
	LCD Screen						✓		✓	
	Activ. Carbon (Gas phase) pre-filter						✓		✓	
	UV light								✓	
Design air flow rate	m <sup>3</sup> /h	2,000								
Application	Floor standing type									
Casing	Colour	Painted galvanized steel finish								
Dimensions	Unit	HxWxD	mm	1,628 X 720 x 770						
Weight	Unit	kg		150 (depending on version)						
Pre-filter	Dust collecting method	Prefilter RedPleat, ISO Coarse 70%			Prefilter RedPleat Carb, ISO Coarse 65% gas phase filter					
HEPA filter	Bacteria filtering method	Astrocel III HEPA H14								
Air purifying operation	Power input	High fan speed	kW	0.379						
UV-irradiation unit	Power input	kW		-				0.025		
Sound pressure level	Air purifying operation	High fan speed	dBA	55.9						
Fan Motor	Stepless adjustable									
Safety devices	Item	Safety switch (operation stops when the back door is open)								
Standard Accessories	Prefilter	1								
	HEPA filter	1								
	Quick Start and Maintenance Guide	1								
	Installation and Operation Manual	1 (download)								
Power cord	m		3							
Power supply	Phase	1~								
	Frequency	Hz	50/60							
	Voltage	V	230							
Running current	Air purifying operation	High fan speed	A	1.73						

# IEQ Sensor

## Our New Indoor Environmental Quality Sensor

The Daikin IEQ Sensor measures your well-being by tracking indoor air quality values, environmental comfort, and electromagnetic pollution. It is available with 12 sensors and 15 parameter measures, and connects through your Wi-Fi network or via NB-IoT technology.



### Complete Standalone Installation

The Daikin IEQ Sensor does not have to be paired with another product, for an **extremely easy and completely standalone installation** that takes about a minute. The device can be powered up with **microUSB power supply (included)**.



### Caelum Monitoring Platform

The device connects to Caelum, Daikin's monitoring platform, at [www.daikiniaq.com](http://www.daikiniaq.com). This **enables you to easily monitor Indoor Air Quality levels and create regular reports based on the data detected by the sensor**. You can even use the platform to show your indoor air quality levels to your visitors.

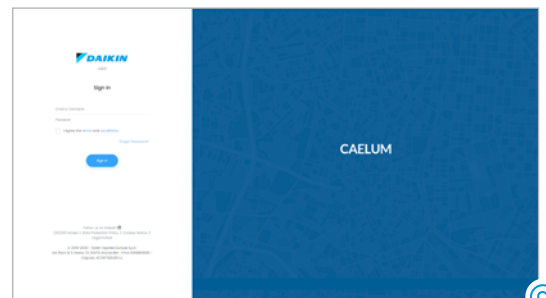

### Mobile App

The **mobile app is available as Daikin AirSense on both the App Store and Play Store**. Once installed on your mobile device and logged in, scan the QR code on the IAQ sensor and **the app will guide you through the entire configuration process**. Once your sensor is configured, you will have access to the entire set of functions from your mobile.



### Connectivity

The IEQ sensor ensures **perfect integration with Daikin on Site and Daikin Cloud Service, Daikin's remote monitoring and smart maintenance platform**. It gives you perfect control over the entire heating, ventilation and air conditioning system installed in your building.





## Green Building Certification

Installing the Daikin IEQ sensor can help you achieve better sustainability ratings and green building projects certified with **LEED and WELL certification** thanks to **Indoor Environmental Quality credits**.



## Video wall

The video wall is a great tool to have a general overview of the measurements conducted by the device. This screen can be shared with the occupants of the buildings to show in each moment the Indoor Air Quality status.

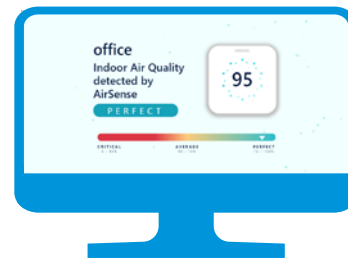

## Communication capability

**IoTNB:** This technology can reach devices in areas where reception is poor or difficult to reach. Complete standalone installation. This is a perfect solution for service purposes where access to local Wi-Fi is not allowed or not available.

**Wi-Fi:** Easy and complete standalone installation.



85 x 85 x 60 mm

## Sensor characteristics

<b>Ambient Light</b>	<b>Electrosmog</b>
Range: 0 lux to 120000 lux	LF Range: 0-400000 nT - Range: 5 Hz - 120 Hz
Precision: ±10%	Precision: ±5% - Resolution: 25nT
Resolution: 0,1 lux	HF Range: 0 - 10 V/m - Range: 50 MHz - 300 GHz
	Precision: ±10% - Resolution: 0,1 V/m
	Measurements performed on 3 axes
<b>Temperature</b>	<b>Air quality</b>
Range: -40 °C a 85 °C	Range: 0 to 500
Precision: ±1 °C (between 0 °C and 65 °C)	Precision: ±10%
Resolution: 0,1 °C	Resolution: 0,1
<b>Humidity</b>	<b>CO<sub>2</sub></b>
Range: 0 to 100% RH	Range: 0 to 5000 ppm
Precision: ±3% RH	Precision: ±30 ppm (between 0 and 1000 ppm)
Resolution: 0,1% RH	±3% (over 1000 ppm)
<b>Air Pressure hPa</b>	Resolution: 1 ppm
Range: 300 to 1100 mbar (hPa)	<b>TVOC</b>
Precision: ± 1 mbar (hPa)	Range: 0 ppb to 1187 ppb
Resolution: 0,18 mbar (hPa)	Resolution: 1 ppb
<b>Sound Pressure</b>	Precision: ±10%
Range: 35 to 120 dBspl	<b>CO<sub>2</sub>e</b>
Frequency: from 50 Hz to 20 KHz	Range: 400 to 8192 ppm
Precision: ±1 dBspl	Precision: ±10%
Resolution: 0,1 dBspl	Resolution: 1 ppm
<b>Fine Dust</b>	<b>Wi-Fi Networks &amp; SIGNAL INTENSITY (2,4GHz band)</b>
Concentration PM10/PM2.5: 0 µg/m <sup>3</sup> to 1000 µg/m <sup>3</sup>	Detects Access Point n° in band 2.4Ghz
Measure:	and overall signal level (from 0 to -100 dBm)
Precision: (from 0 µg/m <sup>3</sup> to 100 µg/m <sup>3</sup> ) : ±15 µg/m <sup>3</sup>	
Precision: (from 100 µg/m <sup>3</sup> to 1000 µg/m <sup>3</sup> ) : ±15%	
Resolution: 1 µg/m <sup>3</sup>	



# Connect with Daikin

If you are a user or installer it is important you can **interact with our systems** in the easiest way, from **anywhere you are**. For any user our interfaces create **peace of mind** that their system is running in the best possible way.

Depending on the type of user and application Daikin develops controls and cloud services to ensure the best experience.

- > For home owners it means **app and voice control** of their home comfort.
- > For hotel owners it means easy and stylish **personal control for guests**, with an integration in hotel booking software for central control
- > For technical managers it means **cloud access** to all sites, with the possibility to benchmark, optimize performance
- > For installers it means **easy transfer of settings during commissioning**, remote retrieval of errors and preventive alerts to save time on maintenance or interventions





Our controls enable you to **connect with your customer**, save time, improve your comfort intelligently and reduce energy bills.



## Remote monitoring



# Control Systems

Application overview	112
Individual control systems	114
<b>NEW</b> Onecta App	114
Madoka wired remote controller	118
Wired / infrared remote controllers	121
Multi-zone controller	122
Centralised control systems	124
Centralised remote controller / Unified ON/OFF controller	124
 Intelligent Controller	125
 Intelligent Controller	126
 Intelligent Manager	128
Standard protocol interfaces	132
Modbus interface	132
DIII-net Modbus Interface	134
KNX Interface	135
Daikin Cloud Service for commercial DX systems 	136
Other devices	138
Wireless room temperature sensor	138
Wired room temperature sensor	138
Other integration devices	139

# Control solutions summary

Daikin offers various control solution adapted to the requirements of even the most demanding commercial application.

- > Basic control solutions for those customers with few requirements and limited budget
- > Integrating control solutions for those customers that would like to integrate Daikin units into their existing BMS system
- > Advanced control solutions for those customers that expect Daikin to deliver a mini BMS solution, including advance energy management

## Shop

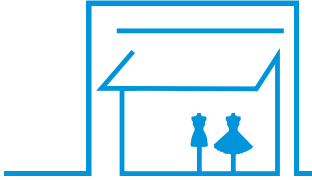

	Unit control			Integrating control			Advanced control	
	BRP069*	BRC1H52W/S/K	RTD-20	RTD-Net	KLIC-DI	EKMBOXA	DCC601A51	DCM601A51
	Smartphone control for up to 50 indoor units	1 remote controller for 1 indoor unit (group)	1 gateway for 1 indoor unit (group)	1 gateway for 1 indoor unit (group)	1 gateway for 1 indoor unit	1 gateway for max. 64 indoor unit(s) (groups) & 10 outdoors	1 unit for 32 indoor unit(s) (5)	1 iTM for 64 indoor unit(s) (groups) (1)
Automatic control of A/C	●	●	●	●	●	●	●	●
Limit control possibilities for shop staff	●	●	●	●	●	●	●	●
Create zones within the shop			●				●	●
Interlock with eg. Alarm, PIR sensor			●				● (limited)	●
Integration into smart home systems	● (7)							
Integrate Daikin units into existing BMS via Modbus				●		●		
Integrate Daikin units into existing BMS via KNX					●			
Integrate Daikin units into existing BMS via HTTP								●
Monitor energy consumption	● (4)	● (4)					● (2)	●
Advanced energy management							● (2)	● (6)
Allows free cooling								●
Voice control	● (6)							
Integrate Daikin products cross pillars into Daikin BMS								●
Integrate third party products into Daikin BMS							●	●
Online control	●						● (2)	● (3)
Manage multiple sites							● (2)	● (3)

(1) 7 iTM plus adapters (DCM601A52) can be added to have 512 indoor groups and 80 outdoor (systems) (2) Via Daikin cloud service (3) Through own IT set-up (not Daikin cloud server) (4) Not available on all indoors (5) Up to 10 DCC601A51 can be combined as a single site on Daikin Cloud Service (6) Only for BRP069C51, connection to Google Assistant and Amazon Alexa; (7) only for BRP069C51, contact your local sales representative for an overview of available services.

## Hotel

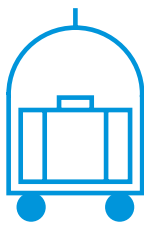

	Unit control	Integrating control		Advanced control	
	BRC1H52W/S/K	RTD-HO	KLIC-DI	DCM010A51	DCM601A51
	1 remote controller for 1 indoor unit (group)	1 gateway for 1 indoor unit (group)	1 gateway for 1 indoor unit	1 interface for up to 2,500 indoor units	1 iTM for 64 indoor unit(s) (groups) (1)
Hotel guest can control & monitor basic functionalities from his room	●	●	● (3)		●
Limit control possibilities for hotel guests	●	●	●	●	●
Interlock with window contact	● (2)	●			●
Interlock with key-card	● (2)	●			●
Integrate Daikin units into existing BMS via Modbus		●			
Integrate Daikin units into existing BMS via KNX			●		
Integrate Daikin units into existing BMS via HTTP					●
Integrate Daikin unit control in hotel booking software				●	
				Oracle Opera PMS	
Monitor energy consumption					●
Advanced energy management					●
Integrate Daikin products cross pillars into Daikin BMS					●
Integrate third party products into Daikin BMS					●
Online control					●

(1) 7 iTM plus adapters (DCM601A52) can be added to have 512 indoor groups and 80 outdoor (systems) (2) Via BRP7A51 adapter (3) requires KNX compatible controller



# Application overview

## Office



	Unit control	Integrating control			Advanced control	
	BRC1H52W/S/K	EKMBDXB	DMS504B51	DMS502A51	DCC601A51	DCM601A51
	1 remote controller for 1 indoor unit (group)	1 gateway for max. 64 indoor unit(s) (groups) & 10 outdoors	1 gateway for 64 indoor unit(s) (groups)	1 gateway for 128 indoor unit(s) (groups), 20 outdoors (2)	1 unit for 32 indoor unit(s) (groups) (5)	1 iTM for 64 indoor unit(s) (groups) (1)
Automatic control of A/C	●	●	●	●	●	●
Centralised control for management		●	●	●	●	●
Local control for office staff	●				● (4)	● through Web Remote management
Limit control possibilities for office staff	●	●	●	●	●	●
Integrate Daikin units into existing BMS via Modbus		●				
Integrate Daikin units into existing BMS via HTTP						●
Integrate Daikin units into existing BMS via LonTalk			●			
Integrate Daikin units into existing BMS via BACnet				●		
Energy consumption read out	● (3)					
Monitor energy consumption					● (4)	●
Advanced energy management					● (4)	●
PPD software to distribute used kWh/indoor unit				● (6)		● (7)
Integrate Daikin cross pillar products into Daikin BMS						●
Integrate third party products into Daikin BMS					●	●
Online control					● (4)	●
Manage multiple sites					● (4)	● (5)

(1) 7 iTM plus adapters (DCM601A52) can be added to have 512 indoor groups and 80 outdoor (systems) (2) extension (DAM411B51) needed to have up to 256 indoor unit(s) (groups), 40 outdoors (3) Not available on all indoor units (4) Via Daikin cloud service (5) Through own IT set-up (not Daikin cloud sever) (5) Up to 10 DCC601A51 can be combined as a single site on Daikin Cloud Service (6) via DAM412B51 option (7) via DCM002A51 option

## Infrastructure cooling



	Unit	Integrating	Advanced
	BRC1H52W/S/K	RTD-10	DCM601A51
	1 remote controller for 1 indoor unit (group) (2)	1 gateway for 1 indoor unit (group) Up to 8 gateways can be linked together	1 iTM for 64 indoor unit(s) (groups) (1)
Automatic control of A/C	●	●	●
Back-up operation	●	●	●
Duty rotation	●	●	●
Limit control possibilities in the technical cooling room	●	●	●
If room temperature above max., then show alarm & start standby unit.		●	●
If an error occurs, an alarm will be shown.	●	●	●
If an error occurs, activate an alarm output	Via KRP2/4A option (3)	●	Via WAGO I/O

(1) 7 iTM plus adapters (DCM601A52) can be added to have 512 indoor groups and 80 outdoor (systems) (2) Infrastructure cooling functions only compatible with indoor units connected to RZQG\*/RZAG\* outdoor units. (3) See option list of indoor unit

# Onecta App

Now available with voice control

The Onecta App is for those who live their life on the go and who want to manage their heating and cooling system from their smartphone.

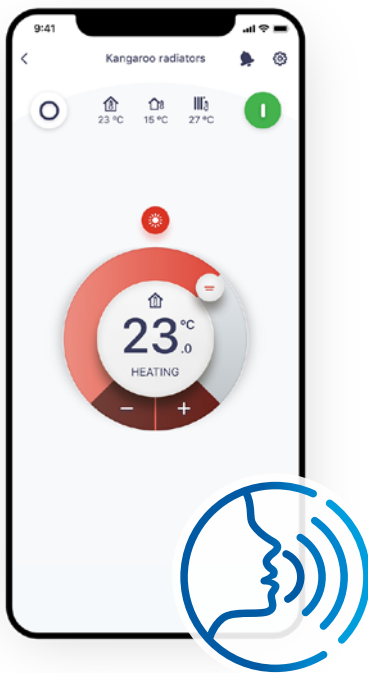

# onecta

NEW

## Voice control

To provide users with even more comfort and ease, the Onecta App now offers voice control. This hands-free feature cuts down on clicks to manage units faster than ever before.

Cross-functional and multilingual, voice control pairs well with any smart device, including Google Assistant and Amazon Alexa.

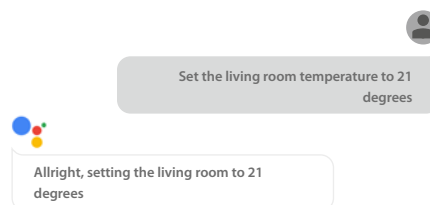

Example of using the voice control via Google Assistant

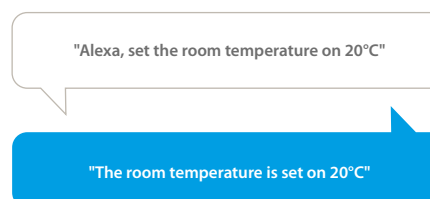

Example of using the voice control via Amazon Alexa

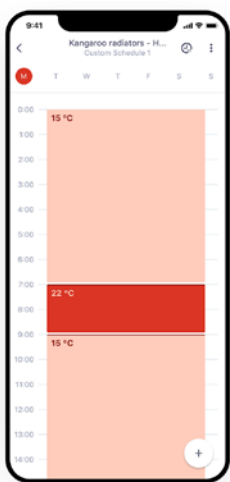

## Schedule

Set up a programme outlining when the system should operate, and create up to six actions per day.

- Schedule room temperature and operation mode
- Enable holiday mode to save costs

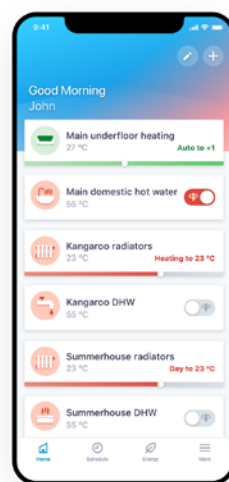

## Control

Customise the system to fit your lifestyle and year-round comfort levels.

- Change room and domestic hot water temperature
- Turn on powerful mode to boost hot water production



## Monitor

Receive a thorough overview of how the system is performing and how much energy it consumes.

- Check the status of the heating system
- Access energy consumption graphs (day, week, month)

Function availability depends on the system type, configuration and operation mode. The app functionality is only available if both the Daikin system and the app have a reliable internet connection.



Scan the QR code to download the app now



## Individual control systems

### Onecta connectable units

#### Integrated in unit

- > FTXA-AW/BS/BT/BB
- > C/FTXM-R
- > FVXM-A
- > FTXTA-BW/BB
- > FTXTM-R
- > ATXM-R

#### BRP069B41

- > FTXJ-MW/S \*

#### BRP069B42

- > FTXZ-N
- > FVXM-F

#### BRP069B45

- > FTXP-M9
- > ATXP-M
- > FTXF-D
- > FTXTP-M\*
- > ATXTP-M\*
- > FTXC-C
- > ATXC-C

#### BRC069C81 \*\*

- Ceiling mounted**
- > FFA-A9
- Concealed ceiling**

- > FDXM-F9
- > FBA-A(9)
- > FDA125A
- > ADEA-A

#### Wall mounted

- > FAA-B

#### Ceiling suspended

- > FHA-A(9)
- > FUA-A

#### Floor standing

- > FVA-A
- > FNA-A9

#### BRC069C82 \*\*

#### Ceiling mounted

- > FCAHG-H
- > FCAG-B
- > FDA200-250A

#### BRP069C51 \*\*\*

#### VRV 5 indoor units

- > FXFA-A
- > FXZA-A
- > FXDA-A
- > FXSA-A
- > FXMA-A
- > FXHA-A
- > FXUA-A
- > FXAA-A

\* adapter included with the unit

\*\* Wired remote controller must be connected to the indoor unit to operate online controller

\*\*\* Must be combined with BRC1H52W/S/K

### Onecta app connectable units:



			Connectivity				
			BRP069A71	BRP069A78	BRP069A61/62	DRGATEWAYAA	EHS157056 (RoCon G1)
Daikin Altherma 3 H HT (F/W)	14-16-18 kW	EPRA14-18D + ETV/B*-E	•	• (1)			
Daikin Altherma 3 H HT ECH2O	14-16-18 kW	EPRA14-18E + ETS*-D					•
Daikin Altherma 3 H MT (F/W)	8-10-12 kW	EPRA08-12E + ETV/B*-E	•	• (1)			
Daikin Altherma 3 H MT (ECH2O)	8-10-12 kW	EPRA08-12E + ETS*-E	•	• (1)			
Daikin Altherma 3 R (F/W)	4-6-8kW	ERGA-E + EHV/B*-E	•	• (1)			
Daikin Altherma 3 R ECH2O	4-6-8kW	ERGA-E + EHS*-D3					•
Daikin Altherma 3 R (F/W)	11-14-16 kW	ERLA-D + EBV/B*-D	•	•			
Daikin Altherma 3 R ECH2O	11-14-16 kW	ERLA-D + EBS*-D	•	•			
Daikin Altherma 3 H (F/W)	11-14-16 kW	EPGA-D + EAV/B*-D			•		
Daikin Altherma R (F/W)	11-14-16 kW	ER(H/L)Q-C + EHV/B*-B			•		
Daikin Altherma R ECH2O	11-14-16 kW	ER(H/L)Q-C + EHS*-B					•
Daikin Altherma 3 M	11-14-16 kW	E(B/D)LA-D		•			
Daikin Altherma M	5-7 kW	EBLQ-CV3			•		
Daikin Altherma R Hybrid	5-8 kW	EVLQ-CV3			•		
Daikin Altherma H Hybrid	4 kW	EJHA-AV3			•		
Daikin Altherma GEO	10 kW	EGSQH-A9W			•		
Daikin Altherma 3 GEO	6-10 kW	EGSA(H/X)-D9W			• (2)		
Daikin Altherma 3 C Gas W	12-35 kW	D2CND-A1A/A4A				•	
Daikin Altherma C Gas ECH2O	15-28 kW	D2UGB/GC-A					•

(1) Included in accessory bag.

(2) Equivalent of BRP069A61 built in.

Wireless LAN Connecting Adaptor BRP069 meets all of the following:

A. Generally available to the public by being sold, without restriction, from stock at retail selling points by means of any of the following: 1. Over-the-counter transactions; 2. Mail order transactions; 3. Electronic transactions; or 4. Telephone call transactions;

B. The cryptographic functionality cannot easily be changed by the user;

C. Designed for installation by the user without further substantial support by the supplier.



## Madoka wired remote controller

# Madoka

# The beauty of simplicity.



Silver  
RAL 9006 (metallic)  
BRC1H52S



Black  
RAL 9005 (matte)  
BRC1H52K



White  
RAL9003 (glossy)  
BRC1H52W

## User-friendly wired remote controller with premium design

Madoka combines refinement and simplicity

- › Sleek and elegant design
- › Intuitive touch-button control
- › Three display options: standard, detailed and **new symbolic view**
- › Three colours to match any interior
- › Compact, measures only 85 x 85 mm
- › Advanced settings **copy function** and commissioning via smartphone



reddot award 2018  
winner





# Madoka Assistant



Simplifies the advanced settings such as schedule or set point limitation

- Visual interface simplifies advanced settings such as schedule setting, energy saving activation, setting restrictions, etc.
- Save field settings and schedules on your phone and upload to multiple controllers, saving time and cost
- Easy and quick commissioning
- Featuring Bluetooth® low energy technology

Easy setting of schedules

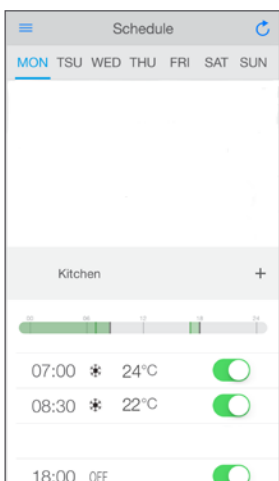

Advanced user settings

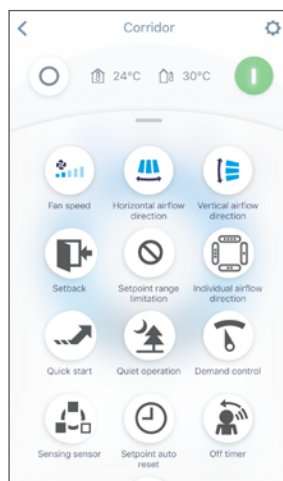

**NEW**

Bluetooth strength indication

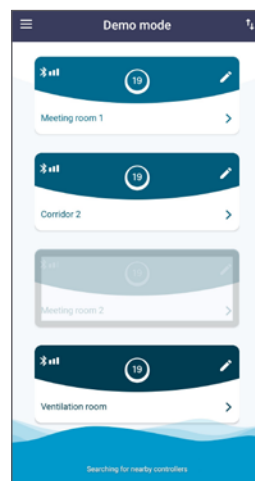

Field settings

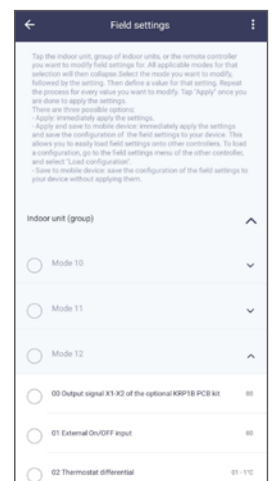

BRC1H519W7 / BRC1H519S7 / BRC1H519K7

## Madoka wired remote controller for Sky Air and VRV



BRC1H52W



BRC1H52S



BRC1H52K

### A complete redesigned controller focussed to enhance user experience

- › Sleek and elegant design
- › Intuitive touch-button control
- › Three display options: standard, detailed and **new symbolic view**
- › Direct access to basic functions (on/off, set point, mode, target values, fan speed, louvres, filter icon & reset, error & code)
- › Three colours to match any interior
- › Compact, measures only 85 x 85 mm
- › Real time clock with auto update to daylight saving time

### Hotel application features

- › Energy saving through key card, window contact integration and set point limitation (BRP7A\*)
- › Flexible setback function ensures room temperature remains within comfortable limits to ensure guest comfort

### Key card and window contact integration

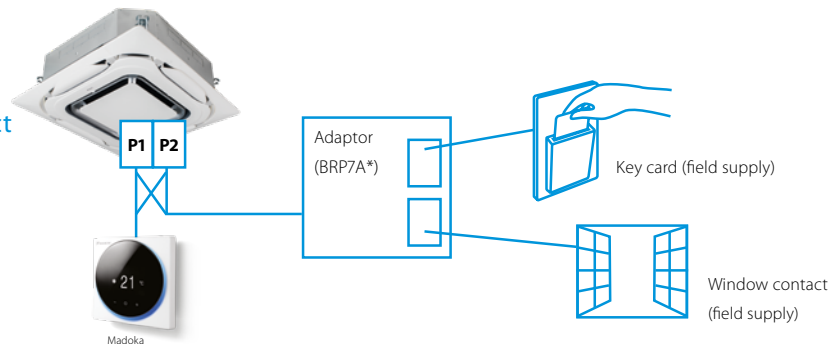

### Madoka Assistant: Advanced settings can be easily done via your smartphone

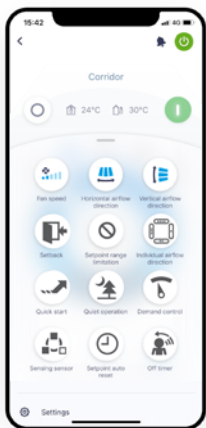

### A range of energy-saving functions that can be selected individually

- › Temperature range restriction: Save on energy by setting the low temperature limit in cooling mode and the high temperature limit in heating mode (1)
- › Setback function
- › Adjustable presence detector and floor sensor (available on the Round Flow and Fully Flat Cassettes)
- › Automatic temperature reset
- › Auto off timer

### Kilowatt-hour consumption tracking (2)

The kWh indicator displays indicative power consumption for the last day/month/year.

### Other functions

- › **NEW** Three user access levels: Basic user, Advanced and Installer to match user requirements and prevent improper use.
- › Save field settings and schedules on your phone and upload to multiple controllers, saving time and cost
- › **NEW** Mark frequently used menu's as favourites for direct access
- › Up to three independent schedules can be programmed, allowing you to switch easily between them throughout the year (e.g. summer/winter/mid-season)
- › Menu settings can be individually locked or restricted
- › The outdoor unit can be set to quiet mode and power consumption limit control by schedule (3)
- › Real-time clock that updates automatically for daylight saving



### Cost-effective solution for infrastructure cooling applications

- › Only in combination with RZAG\* / RZQG\*
- › Duty rotation

After a certain period of time, the operating unit will go into standby and the standby unit will take over, extending the system lifetime. Rotation interval can be set for 6, 12, 24, 72 or 96 hours, as well as weekly.

- › Back-up operation: if one unit fails, the other unit will start automatically

(1) Also available in auto cooling/heating changeover mode  
 (2) For Sky Air FBA, FCAG and FCAHG pair combinations only

(3) Only available on RZAG\*, RZASG\*, RZQG\*, RZQSG\*



BRC1E53A/B/C

## User friendly remote control for Sky Air and VRV



Graphical display of indicative electricity consumption (Function available in combination with FBA-A, FCAG and FCAHG)



### A series of energy saving functions that can be individually selected

- › Demand control (1)
- › Temperature range limit
- › Setback function
- › Presence & floor sensor connection (available on round flow and fully flat cassette)
- › kWh indication (2)
- › Set temperature auto reset
- › Off timer

### Cost-effective solution for infrastructure cooling applications

- › Only in combination with Sky Air A-series or Seasonal Smart outdoor unit

### Other functions

- › Up to 3 independent schedules
- › Possibility to individually restrict menu functions
- › Choice of display between symbol or text
- › Real time clock with auto update to daylight saving time
- › Built-in backup power for clock (up to 48 hours). Settings are always kept in case of power loss.
- › Supports multiple languages:  
BRC1E53A: English, German, French, Dutch, Spanish, Italian, Portuguese  
BRC1E53B: English, Czech, Croatian, Hungarian, Romanian, Slovenian, Bulgarian  
BRC1E53C: English, Greek, Russian, Turkish, Polish, Slovak, Albanian

(1) Only available on RZAG\*, RZASG\*, RZQG\*, RZQSG\* | (2) For Sky Air FBA, FCAG and FCAHG pair combinations only

BRC1D52

## Wired remote control for Sky Air and VRV



BRC1D52

- › Schedule timer: Five day actions can be set
- › Home leave (frost protection): during absence, the indoor temperature can be maintained at a certain level. This function can also switch the unit ON/OFF
- › User friendly HRV function, thanks to the introduction of a button for ventilation mode and fan speed
- › Immediate display of fault location and condition
- › Reduction of maintenance time and costs

ARC4\*/BRC4\*/BRC7\*

## Infrared remote control



ARC466A1



BRC4\*/BRC7\*

Operation buttons: ON/OFF, timer mode start/stop, timer mode on/off, programme time, temperature setting, air flow direction (1), operating mode, fan speed control, filter sign reset (2), inspection (2)/test indication (2)

Display: Operating mode, battery change, set temperature, air flow direction (1), programmed time, fan speed, inspection/test operation (2)

1. Not applicable for FXDQ, FXSQ, FXNQ, FBDQ, FDXM, FBA
2. For FX\*\* units only
3. For all features of the remote control, refer to the operation manual



# Controls

3 controller versions are available to choose from: Colour, touch or simplified



AZCE6BLUEZEROCB (Wired)

## Bluezero - main thermostat

- › Intuitive graphical, colour touch screen for controlling multiple zones



AZCE6THINKCB (Wired)  
AZCE6THINKRB (Wireless)

## Think - zone thermostat

- › Graphic touch button with low-energy e-ink screen for controlling single zones



AZCE6LITECB (Wired)  
AZCE6LITERB (Wireless)

## Lite - zone thermostat

- › Simplified thermostat with touch buttons for temperature control

- › Optional bus cable (2 x 0.5 mm<sup>2</sup> | 2 x 0.22 mm<sup>2</sup>), 15 m length: AZX6CABLEBUS15, 100m length: AZX6CABLEBUS100



AZX6WSPHUB

## Webserver for remote control

- › Cloud based remote control of multizoning kit(s)
- › Configuration and control of zones (temperature, operation mode, ...)
- › Access via webportal, or Android/IOS application
- › Supports Ethernet and WIFI
- › AZX6WSPHUB:
  - › For installation on DIN rail
  - › 32 zoning boxes can be controlled
- › AZX6WSC5GER:
  - › For installation in the unit
  - › Controls one zoning box



AZX6WSC5GER



AZX6WSPBAC

## BACnet or KNX gateway

- › Allows ON/OFF control of each zone
- › Control of temperature for each zone
- › Status indication of operation mode
- › One gateway needed per system



AZX6KNXGTWAY

# Grilles and plenums

## Supply air grilles and plenums



RDHV040015BKX

## Wall type supply grille

- › With horizontal and vertical adjustable flaps



RLQV040015BKX

## Ceiling type supply grille

- › With horizontal flaps angled at 15°
- › Vertical flaps can be adjusted manually

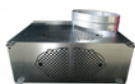

PREJ0400150T

## Plenum for supply grille

- › To connect circular ducts to discharge grille
- › Insulated, galvanised steel
- › Diameter 250mm

## Return air grilles and plenums



RRFR050050BTX

## Return air grille with integrated filter

- › Filters particles from the air

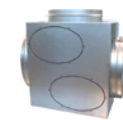

BR500

## Plenum for return grille

- › To connect 1 up to 4 circular ducts to the return air grille
- › Diameter 250mm

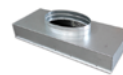

AZCEZDAPR07\*

## Plenum for return air

- › To connect 1 up to 4 circular ducts to the Daikin concealed ceiling units
- › Diameter 250mm
- › Different sizes (XS, S, M, L, XL) to fit the indoor unit

## Centralised remote controller

Centralised control of the Sky Air and VRV system can be achieved via 2 user friendly compact remote controllers. These controls may be used independently or in combination with:

1 group = several (up to 16) indoor units in combination

1 zone = several groups in combination.

A centralised remote control is ideal for use in tenanted commercial buildings subject to random occupation, enabling indoor units to be classified in groups per tenant (zoning).

### DCS302C51

## Centralised remote control



Providing individual control of 64 groups (zones) of indoor units.

- > a maximum of 64 groups (128 indoor units, max. 10 outdoor units) can be controlled
- > a maximum of 128 groups (128 indoor units, max. 10 outdoor units) can be controlled via 2 centralised remote controls in separate locations
- > zone control
- > group control
- > malfunction code display
- > maximum wiring length of 1,000m (total: 2,000m)
- > air flow direction and air flow rate of HRV can be controlled
- > expanded timer function

### DCS301B51

## Unified ON/OFF control



Providing simultaneous and individual control of 16 groups of indoor units.

- > a maximum of 16 groups (128 indoor units) can be controlled
- > 2 remote controls in separate locations can be used
- > operating status indication (normal operation, alarm)
- > centralised control indication
- > maximum wiring length of 1,000m (total: 2,000m)

DCS601C51



Detailed & easy monitoring and operation of VRV systems (max. 64 indoor units groups).

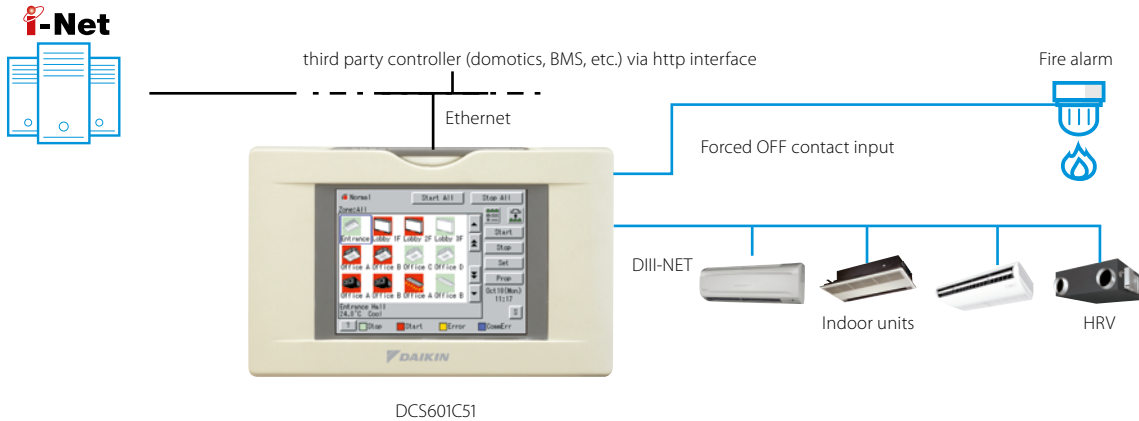

**Languages**

- › English
- › French
- › German
- › Italian
- › Spanish
- › Dutch
- › Portuguese

**System layout**

- › Up to 64 indoor units can be controlled
- › Touch panel (full colour LCD via icon display)

**Control**

- › Individual control (set point, start/stop, fan speed) (max. 64 groups/indoor units)
- › Set back schedule
- › Enhanced scheduling function (8 schedules, 17 patterns)
- › Flexible grouping in zones
- › Yearly schedule
- › Fire emergency stop control
- › Interlocking control
- › Increased HRV monitoring and control function
- › Automatic cooling / heating change-over
- › Heating optimization
- › Temperature limit
- › Password security: 3 levels (general, administration & service)
- › Quick selection and full control
- › Simple navigation

**Monitoring**

- › Visualisation via Graphical User Interface (GUI)
- › Icon colour display change function
- › Indoor units operation mode
- › Indication filter replacement

**Cost performance**

- › Free cooling function
- › Labour saving
- › Easy installation
- › Compact design: limited installation space
- › Overall energy saving

**Open interface**

- › Communication to any third party controller (domotics, BMS, etc.) is possible via open interface (http option DCS007A51)

**Connectable to**

- › VRV
- › HRV
- › Sky Air
- › Split (via interface adapter)

DCC601A51

**Intelligent** Tablet **Controller**

# Advanced centralised controller with Cloud connection

- Intuitive and user-friendly interface
- Flexible concept for stand alone and multi site applications
- Total solution thanks to integration of 3rd party equipment
- Monitor & control your small commercial building, no matter where you are

**2 solutions:**

**Local solution**

- › Offline centralised control
- › Stylish optional screen fits any interior

**Cloud solution**

- › Flexible online control from any device (Laptop, tablet...)
- › Monitor & control one or multiple sites
- › Benchmark the energy consumption of different installations (1)
- › Energy consumption follow-up to comply with local regulations

**System layout**

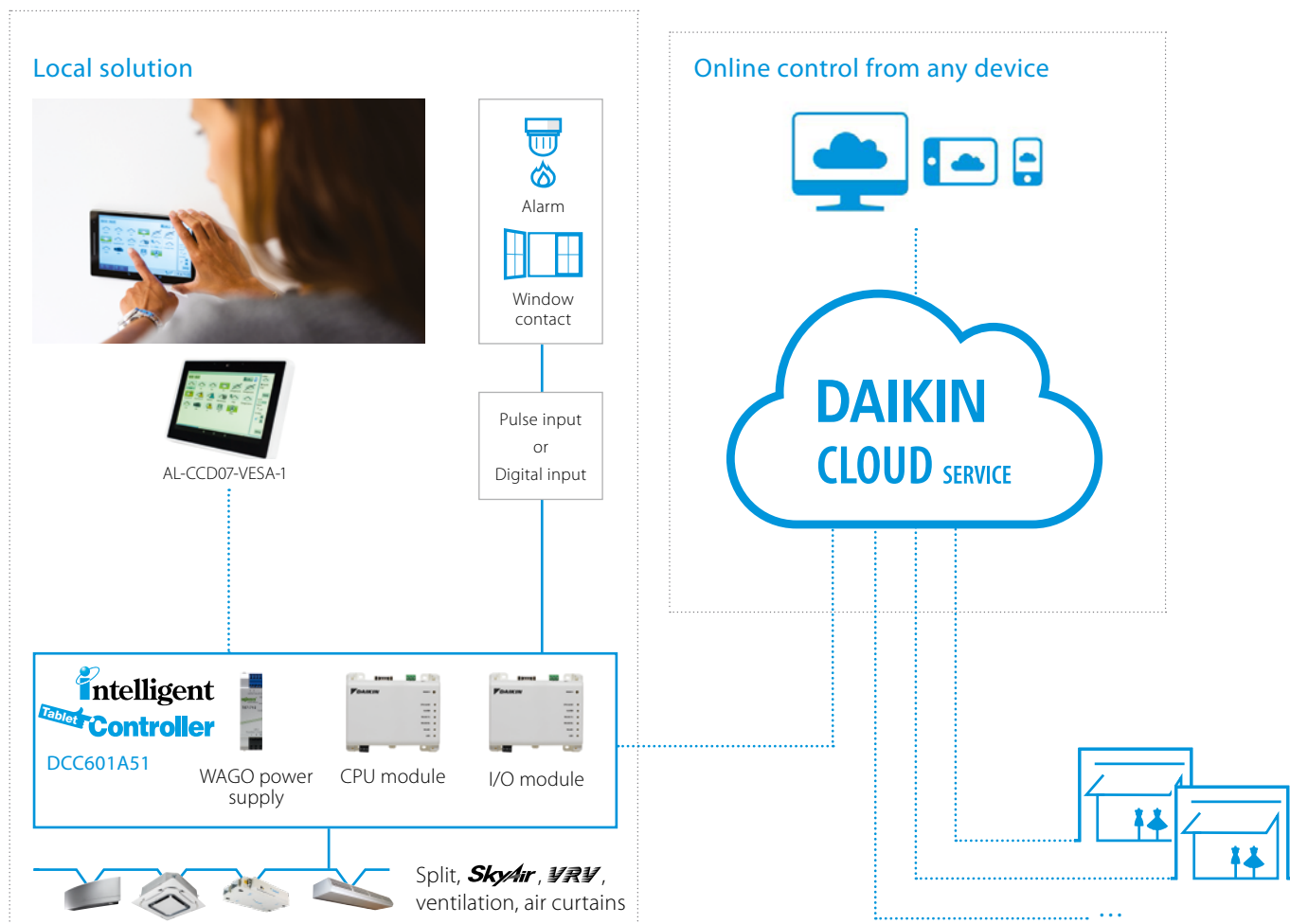

(1) For VRV and Sky Air R-32 ranges the consumption data is integrated; for other (HVAC) systems, field supplied kWh meters will be required

## Centralised control systems

### Total solution

- › Total solution thanks to a large integration of Daikin products and 3rd party equipment
- › Connect a wide range of units (Split, Sky Air, VRV, Ventilation, Biddle air curtains)
- › Simply control your entire building centrally
- › Increased customer shopping experience by better management of your shop comfort level

### Daikin Cloud Services

- › Control your building no matter where you are
- › Monitor and control multiple sites
- › Installer or technical manager can remotely login to the cloud for first troubleshooting
- › Benchmark the energy consumption of different installations (1)
- › Manage & track your energy use

### User friendly touch control

- › Stylish Daikin supplied optional screen for local control fits any interior
- › Intuitive and user-friendly interface
- › Full solution with simple control
- › Easy commissioning

### Flexible

- › Pulse/digital inputs for 3rd party equipment such as kWh meters, emergency input, window contact, ...
- › Modular concept allows your cloud to grow with your business
- › Control up to 32 indoor units per controller and 320 units per site

(1) only available in combination with certain indoor units

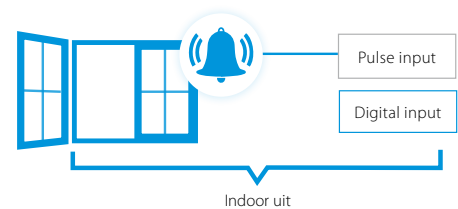
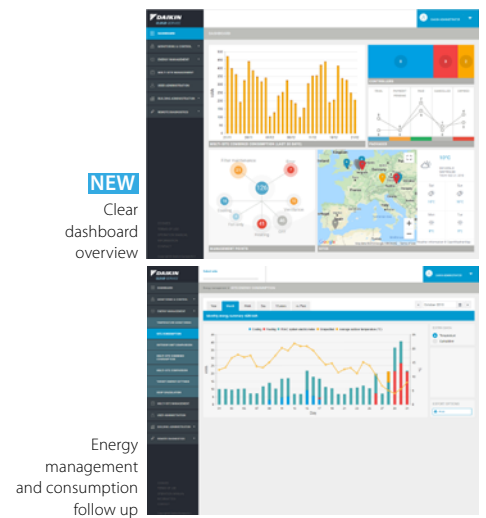
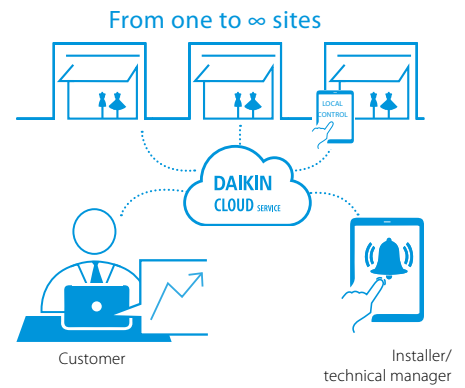

## Functions overview

		Local solution	Cloud solution
<b>Languages</b>		Depends on local device	EN, DE, FR, NL, ES, IT, EL, PT, RU, TR, DA, SV, NO, FI, CS, HR, HU, PL, RO, SL, BG, SK
<b>System layout</b>	N° of connectable indoor units	32	32
	Multiple sites control	●	●
<b>Monitoring &amp; control</b>	Basic control functions (ON/OFF, mode, filter sign, setpoint, fan speed, ventilation mode, room temperature, ...)	●	●
	Remote control prohibition	●	●
	All devices ON/OFF	●	●
	Zone control	●	●
	Group control	●	●
	Weekly schedule	●	●
	Yearly schedule	●	●
	Interlock control	●	●
	Set point limitation	●	●
	Visualisation of energy use per operation mode	●	●
<b>Connectable to</b>	DX split, Sky Air, VRV	●	●
	Modular L Smart, VAM, VKM ventilation	●	●
	Air curtains	●	●

For available Daikin Cloud Service options refer to the option list



# Mini BMS

with full integration  
across all product pillars

DCM601A51



- Price competitive mini BMS
- Cross-pillar integration of Daikin products
- Integration of third party equipment



Download the WAGO  
selection tool from  
[my.daikin.eu](http://my.daikin.eu)

- › Easy selection of WAGO materials
- › Material list creation
- › Time saving
  - Includes wiring schemes
  - Contains commissioning/preset data for iTM



Check on  
**YouTube**

<https://www.youtube.com/DaikinEurope>





# System overview

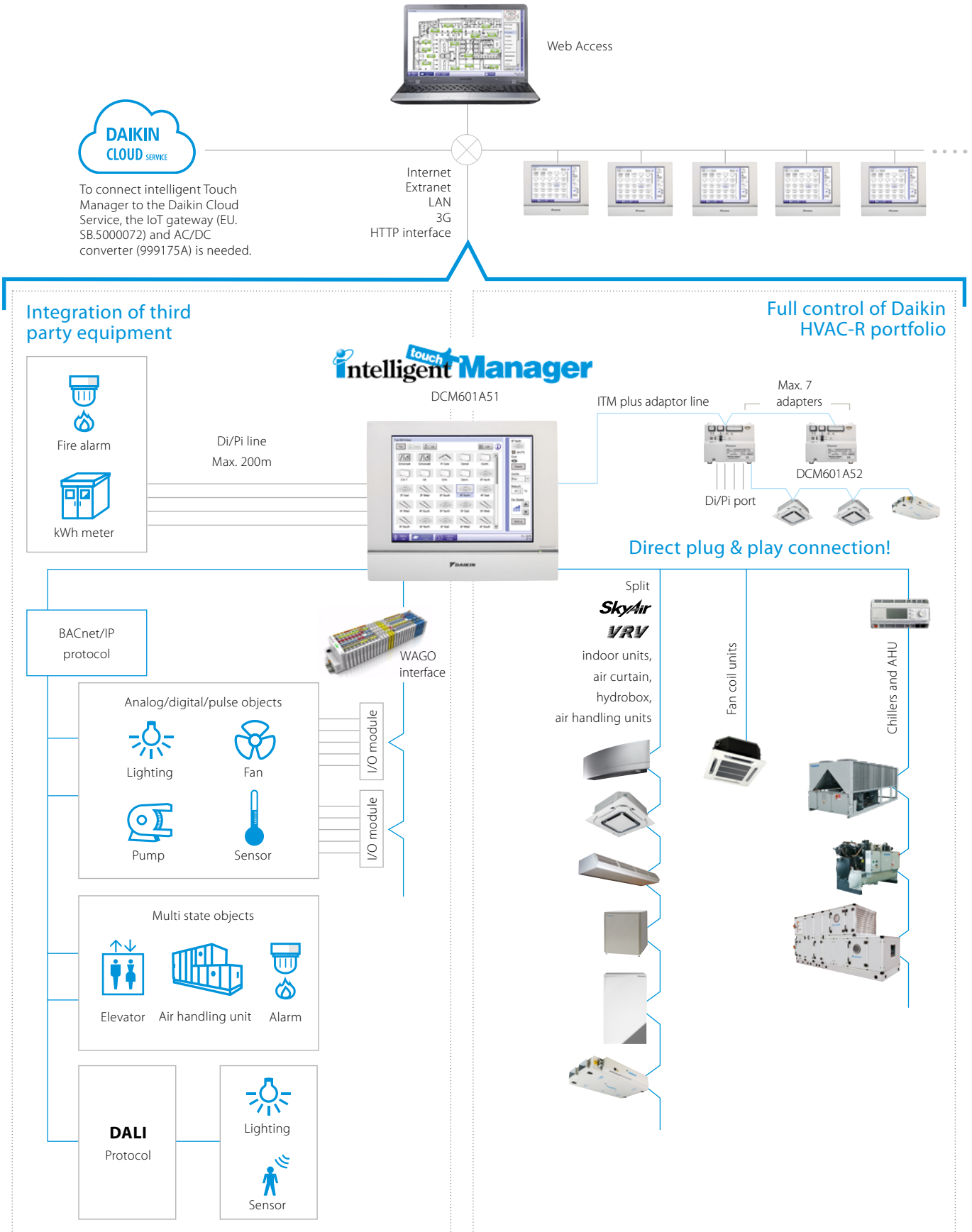



**User friendliness**

- › Intuitive user interface
- › Visual lay out view and direct access to indoor unit main functions
- › All functions direct accessible via touch screen or via web interface

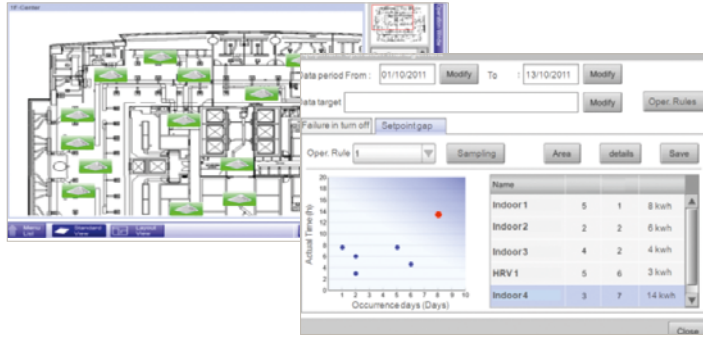

**Smart energy management**

- › Monitoring if energy use is according to plan
- › Helps to detect origins of energy waste
- › Powerful schedules guarantee correct operation throughout the year
- › Save energy by interlocking A/C operation with other equipment such as heating

**Flexibility**

- › Cross-pillar integration (heating, air conditioning, applied systems, refrigeration, air handling units)
- › BACnet protocol for 3rd party products integration
- › I/O for integration of equipment such as lights, pumps... on WAGO modules
- › Modular concept for small to large applications
- › Control up to 512 indoor unit groups via one ITM and combine multiple ITM via web interface

**Easy servicing and commissioning**

- › Remote refrigerant containment check reducing on site visit
- › Simplified troubleshooting
- › Save time on commissioning thanks to the pre-commissioning tool
- › Auto registration of indoor units

**Plug & play**

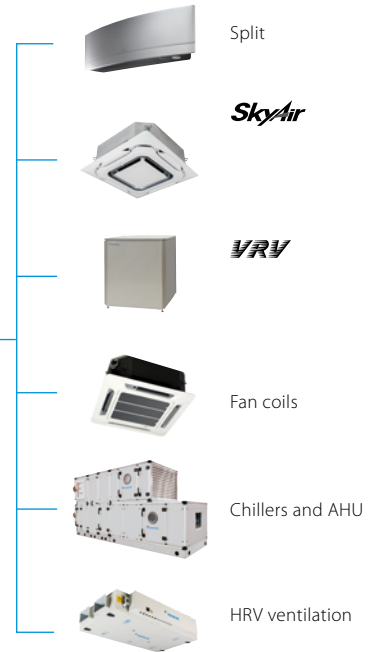

Flexibility in size  
64 up to 512 groups

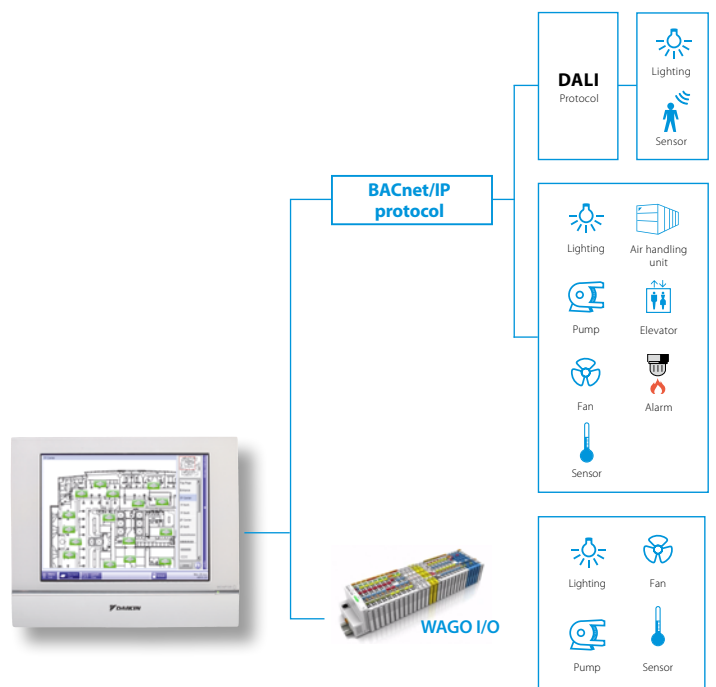
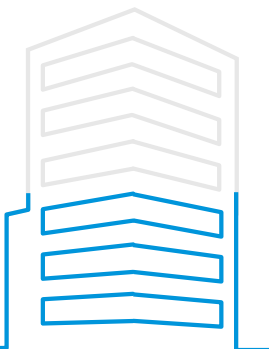

# Functions overview

## Languages

- › English
- › French
- › German
- › Italian
- › Spanish
- › Dutch
- › Portuguese

## Management

- › Web access via html 5
- › Power Proportional Distribution (option)
- › Operational history (malfunctions, ...)
- › Smart energy management
  - monitor if energy use is according to plan
  - detect origins of energy waste
- › Setback function
- › Sliding temperature

## WAGO Interface

- › Modular integration of 3rd party equipment
- › Large variety of input and outputs available. For more details refer to the options list

## Open http interface

- › Communication to any third party controller (domotics, BMS, etc.) is possible via http open interface (http option DCM007A51)

## System layout

- › Up to 512 unit groups can be controlled (ITM + 7 iTM Plus adapters)

## Control

- › Individual control (512 groups)
- › Schedule setting (Weekly schedule, yearly calendar, seasonal schedule)
- › Interlock control
- › Setpoint limitation
- › Temperature limit

## DALI integration

- › Control and monitor the lights
- › Easier facility management: receive error signal when light or light controller has a malfunction
- › Flexible approach and less wiring needed, compared to classic light scheme
- › Easier to make groups and control scenes
- › Connection between intelligent Touch Manager and DALI through WAGO BACnet / IP interface

## Connectable to

- DX Split, Sky Air, VRV
- HRV
- Chillers (via MT3-EKCBACIP controller)
- Daikin AHU (via MT3-EKCBACIP controller)
- Fan coils
- LT and HT hydroboxes
- Biddle Air curtains
- WAGO I/O
- BACnet/IP protocol
- Daikin PMS interface (option DCM010A51)



RTD

# Modbus Interface

**RTD-NET**

- › Modbus interface for monitoring and control of Sky Air, VRV, VAM and VKM

**RTD-10**

- › Advanced integration into BMS of Sky Air, VRV, VAM and VKM through either:
  - Modbus
  - Voltage (0-10V)
  - Resistance
- › Duty/standby function for server rooms

**RTD-20**

- › Retail economisor
- › Advanced control of Sky Air, VRV, VAM/VKM and air curtains
- › Clone or independent zone control
- › Increased comfort with integration of CO<sub>2</sub> sensor for fresh air volume control
- › Save on running costs via
  - pre/post and trade mode
  - set point limitation
  - overall shut down
  - PIR sensor for adaptive deadband

**RTD-HO**

- › Modbus interface for monitoring and control of Sky Air, VRV, VAM and VKM
- › Intelligent hotel room controller

## RTD-20 retail economiser Control zones in shop applications

**Zoning**

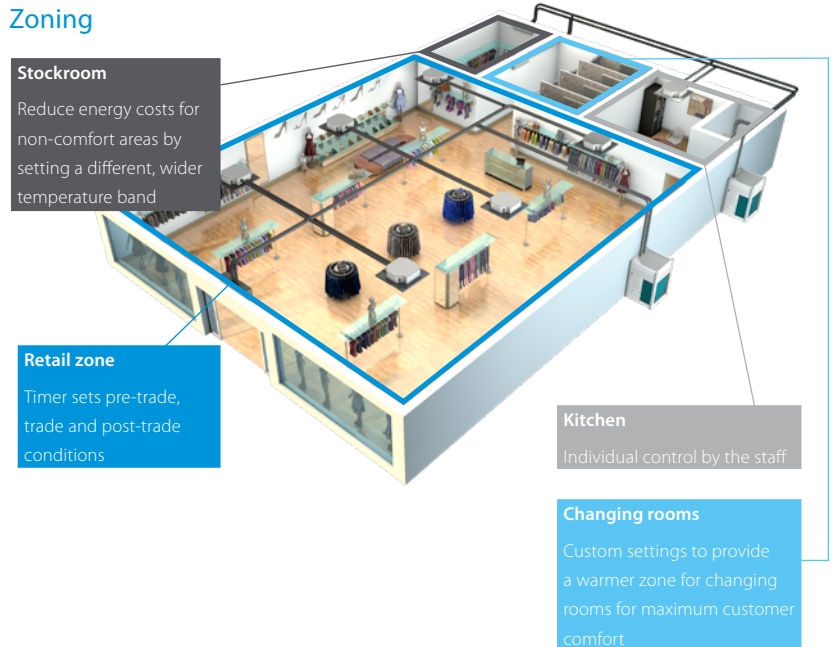

**Control options benefits**

Optimize the operation of the air conditioning without compromising occupant comfort

**Without RTD-20**

- › Pre-trade:
  - AC either on (timer) or off
  - whole store heated or cooled
- › Trading:
  - achieving set-point
  - staff could access controllers
  - heat cool clash can occur
  - door curtain not interlocked
  - always trying to achieve set-point
- › Post-Trade:
  - either on or off

**With RTD-20**

- › Pre-trade:
  - De-stratification on start-up
  - Heat/Cool protection enabled
  - AC only comes on if internal temp above 26°C or below 19°C
  - achieving midpoint of 19-23°C
  - controllers locked
  - heat cool clash prevented
  - door curtain interlocked
  - learns store patterns & heats/cools "enough" to reach set-point
- › Post-Trade:
  - Heat/cool protection enabled
  - Trade extension function

**Integrate all essential store operations in one control**

Optimize the operation of the air conditioning without compromising occupant comfort.

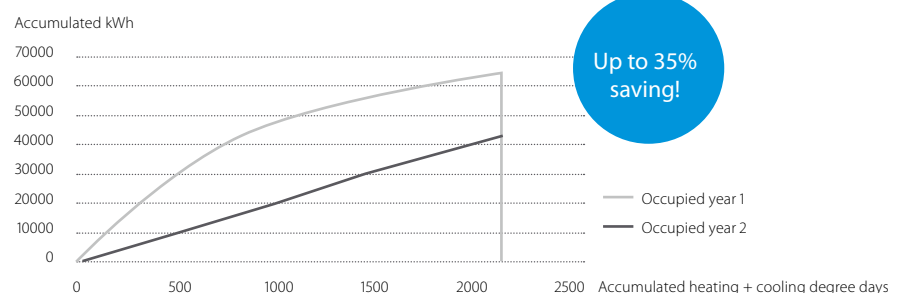

# Overview functions



Main functions	RTD-NET	RTD-10	RTD-20	RTD-HO
Dimensions	H x W x D mm 100 x 100 x 22			
Key card + window contact				✓
Set back function				✓
Prohibit or restrict remote control functions (setpoint limitation, ...)	✓	✓	✓**	✓
Modbus (RS485)	✓	✓	✓	✓
Group control	✓	✓	✓	✓
0 - 10 V control		✓	✓	
Resistance control		✓	✓	
IT application		✓		
Heating interlock		✓	✓	
Output signal (on/defrost, error)		✓	✓****	✓
Retail application			✓	
Partitioned room control			✓	
Air curtain	✓**	✓**	✓	

(!): By combining RTD-RA devices

Control functions	RTD-NET	RTD-10	RTD-20	RTD-HO
On/Off	M	M,V,R	M	M*
Set point	M	M,V,R	M	M*
Mode	M	M,V,R	M	M*
Fan	M	M,V,R	M	M*
Louver	M	M,V,R	M	M*
HRV Damper control	M	M,V,R	M	
Prohibit/Restrict functions	M	M,V,R	M	M*
Forced thermo off				

Monitoring functions	RTD-NET	RTD-10	RTD-20	RTD-HO
On/Off	M	M	M	M
Set point	M	M	M	M
Mode	M	M	M	M
Fan	M	M	M	M
Louver	M	M	M	M
RC temperature	M	M	M	M
RC mode	M	M	M	M
N° of units	M	M	M	M
Fault	M	M	M	M
Fault code	M	M	M	M
Return air temperature (Average /Min/Max)	M	M	M	M
Filter alarm	M	M	M	M
Thermo on	M	M	M	M
Defrost	M	M	M	M
Coil In/Out temperature	M	M	M	M

M : Modbus / R : Resistance / V : Voltage / C: control  
 \* : only when room is occupied / \*\* : setpoint limitation / (\*) if available  
 \*\*\* : no fan speed control on the CYV air curtain / \*\*\*\* : run & fault

EKMBDXB

# DIII-net Modbus interface



Integrated control system for seamless connection between Split, Sky Air, VRV and small inverter chillers and BMS systems

- › Communication via Modbus RS485 protocol
- › Detailed monitoring and control of the VRV total solution
- › Easy and fast installation via DIII-net protocol
- › As the Daikin DIII-net protocol is being used, only one modbus interface is needed for a group of Daikin systems (up to 10 outdoor units systems).

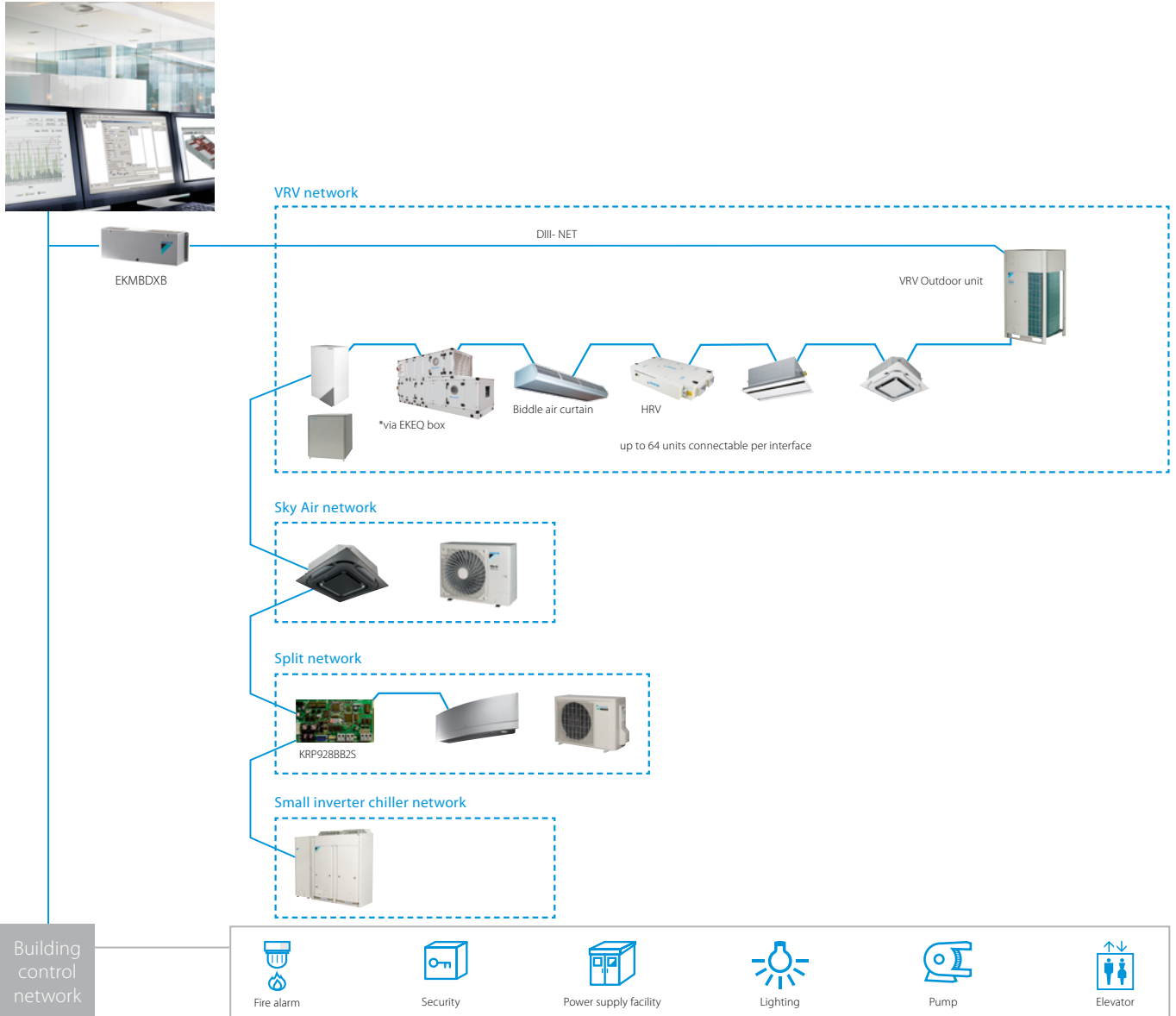

			EKMBDXB7V1	
Maximum number of connectable indoor units			64	
Maximum number of connectable outdoor units			10	
Communication	DIII-NET - Remark		DIII-NET (F1F2)	
	Protocol - Remark		2 wire; communication speed: 9600 bps or 19200 bps	
	Protocol - Type		RS485 (modbus)	
	Protocol - Max. Wiring length	m	500	
Dimensions	HeightxWidthxDepth	mm	124x379x87	
Weight		kg	2.1	
Ambient temperature - operation	Max.	°C	60	
	Min.	°C	0	
Installation			Indoor installation	
Power supply	Frequency	Hz	50	
	Voltage	V	220-240	

KLIC-DDV3  
KLIC-DI\_V2

# KNX interface

Integration of Split, Sky Air and VRV in HA/BMS systems

Connect split indoor units to KNX interface for Home Automation system

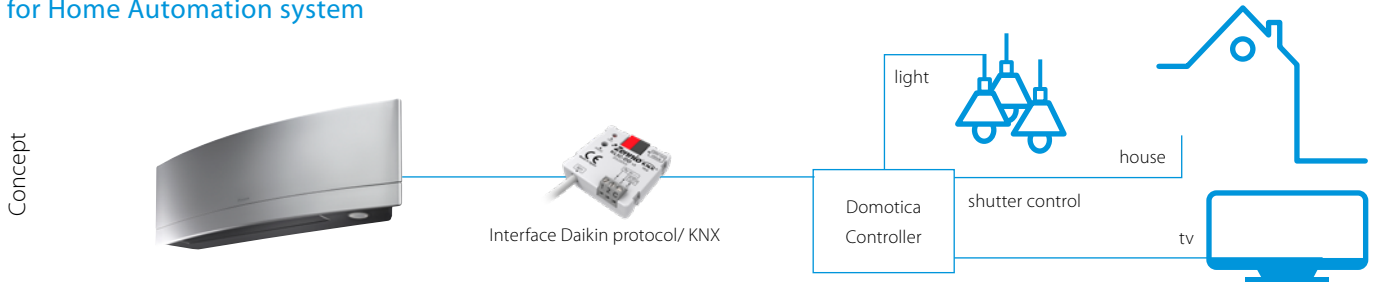

Connect Sky Air / VRV indoor units to KNX interface for BMS integration

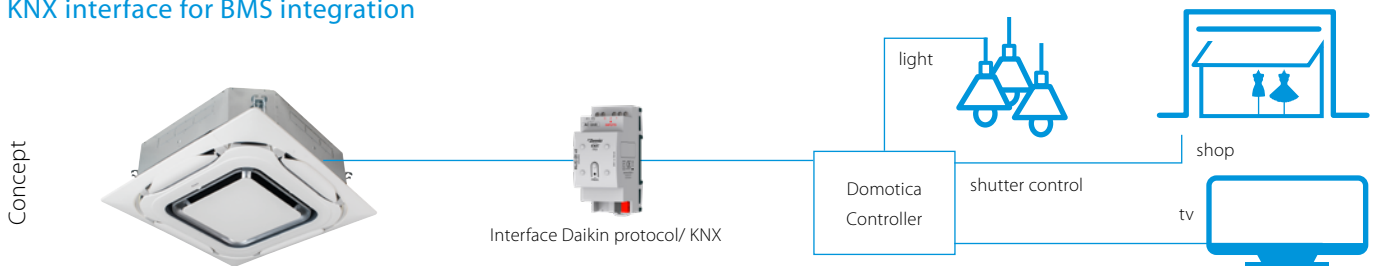



## KNX interface line-up

The integration of Daikin indoor units through the KNX interface allows monitoring and control of several devices, such as lights and shutters, from one central controller. One particularly important feature is the ability to programme a 'scene'

- such as "Home leave" - in which the end-user selects a range of commands to be executed simultaneously once the scenario is selected. For instance in "Home leave", the air conditioner is off, the lights are turned off, the shutters are closed and the alarm is on.

## KNX interface for

	 <b>KLIC-DDV3 size 45x45x15mm</b> Split	 <b>KLIC-DI_V2 size 90x60x35mm</b> Sky Air	<b>VRV</b>
<b>Basic control</b>			
On/Off	●	●	●
Mode	Auto, heat, dry, fan, cool	Auto, heat, dry, fan, cool	Auto, heat, dry, fan, cool
Temperature	●	●	●
Fan speed levels	3 or 5 + auto	2 or 3	2 or 3
Swing	Stop or movement	Stop or movement	Swing or fixed positions (5)
<b>Advanced functionalities</b>			
Error management	Communication errors, Daikin unit errors		
Scenes	●	●	●
Auto switch off	●	●	●
Temperature limitation	●	●	●
Initial configuration	●	●	●
Master and slave configuration		●	●

# Daikin Cloud Service

to achieve optimal operation



Daikin Cloud Service is a cloud-based remote control and monitoring solution for DX systems. Using enhanced control, monitoring and predictive logic, Daikin Cloud Service provides real-time data and support from Daikin experts to help you identify cost-saving opportunities, increase the lifetime of your equipment and reduce the risk of unexpected issues.

Monitor & control\* your system no matter where you are while teaming up with Daikin experts

## Remote control and energy visualisation

### Puts you in the driving seat of your energy management

- ✓ Control and monitor your premises, wherever you are
- ✓ Centralised control and monitoring of all your premises
- ✓ Check errors remotely without having to go on site
- ✓ Visualise energy consumption and reduce energy waste by comparing different premises
- ✓ Graphical visualization of IEQ parameters (frequency day, week, month, year)
- ✓ Export & print IEQ parameters

## Remote support and diagnostics

### Daikin specialist supervision, so you can focus on your core business

- ✓ Early warning of system deviations to maximise system uptime and avoid emergency repairs\*\*
- ✓ Service providers have access to operational data so they arrive on site prepared
- ✓ Remote expert assistance in case of errors

### Multi-site monitoring

From one to an ∞ number of sites

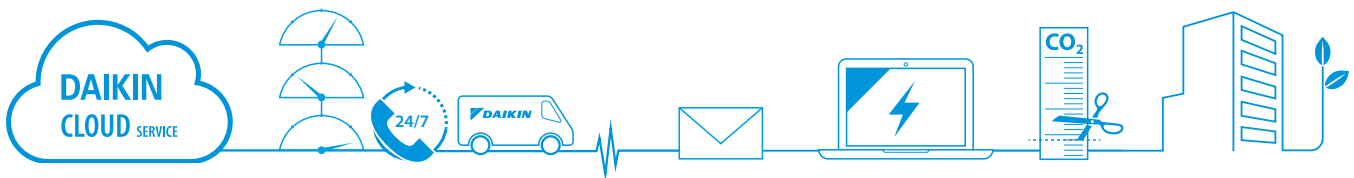
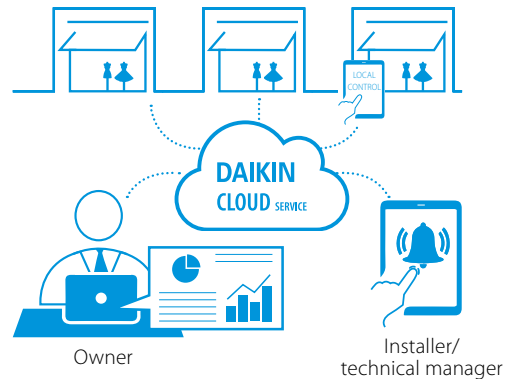

## Advice and optimisation

### Get the best out of your system through expert advice

- ✓ Periodical analysis and optimisation report by experts
- ✓ Personalised actions to maximise energy efficiency and comfort
- ✓ Increased system lifetime as the system runs as it should

**Daikin Cloud Service requires a subscription. Contact your local sales representative for more information.**

\* Remote Control function via Daikin Cloud Service only available for sites with an Intelligent Tablet controller

\*\* Only available for VRV systems



# Daikin Cloud Service packages

	Control and monitoring	Remote support and diagnostics	Advice and optimisation
Remote control, scheduling and interlocking	✓ (DCC601A51 only)	✓ (DCC601A51 only)	✓ (DCC601A51 only)
Energy monitoring	✓	✓	✓
Multi-site benchmark	✓	✓	✓
Alarm history and e-mail notifications**	✗	✓	✓
Predictions and e-mail notifications**	✗	✓	✓
Operational data access	✗	✓	✓
Indoor use analysis	✗	✓	✓
Outdoor use analysis	✗	✓	✓
Remote diagnostic and support from Daikin	✗	✓	✓
Periodical analysis and optimisation advice from Daikin	✗	✗	✓
Can be combined with maintenance programmes: - Technical inspection - Preventive Maintenance Plan - Comprehensive Maintenance Plan	✗	✗	✓

Packages subject to local availability  
Daikin Cloud Service replaces VRV Cloud and i-Net services.

## Flexible solution

Manage your premises according to your needs, using a local control or remotely via Daikin Cloud Service, or a combination of both.

## Control\*, no matter where you are

Daikin Cloud Service gives you full control of one or more premises wherever you are, using your PC, tablet or smartphone.

## Predictive logic for VRV to prevent breakdowns

The operational data is continuously analysed by Daikin algorithms to predict potential failures and avoid unexpected costs.

## Compatible with:

- > Intelligent Tablet Controller (DCC601A51)
- > Intelligent Touch Manager (DCM601A51) + IoT gateway
- > LC8 + IoT gateway



1. Clear dashboard overview

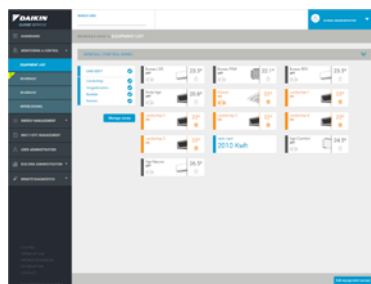

2. Monitor and control your system

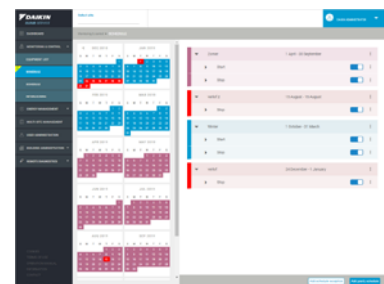

3. Easy setting of schedules



4. Energy management and consumption follow up

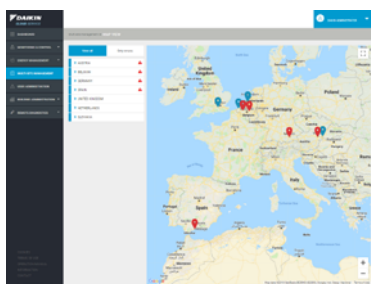

5. Multi site management

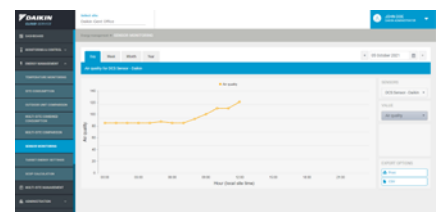

IEQ dashboard on DCS

\* Remote Control function via Daikin Cloud Service only available for sites with an Intelligent Tablet controller

\*\* Only available for VRV systems

K.RSS

# Wireless room temperature sensor

## Flexible and easy installation

- › Accurate temperature measurement thanks to flexible placement of the sensor
- › No need for wiring
- › No need to drill holes
- › Ideal for refurbishment



## Connection diagram Daikin indoor unit PCB (FXSQ example)

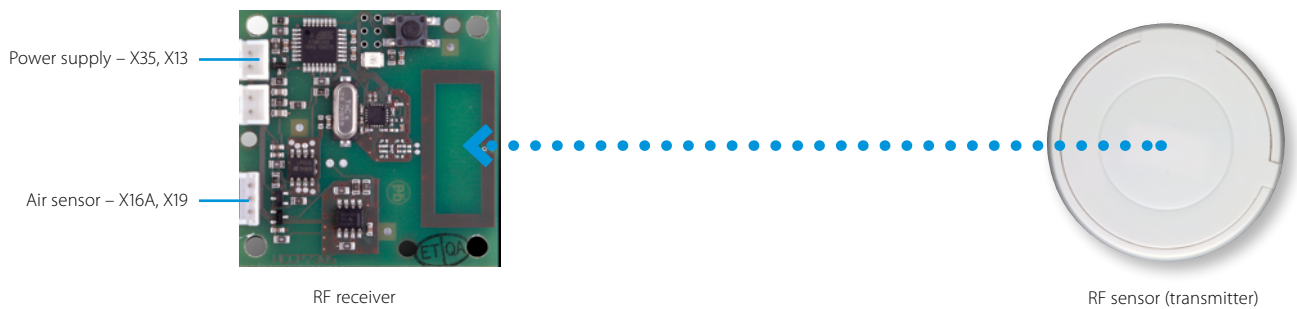

## Specifications

		Wireless room temperature sensor kit (K.RSS)	
		Wireless room temperature receiver	Wireless room temperature sensor
Dimensions	mm	50 x 50	ø 75
Weight	g	40	60
Power supply		16VDC, max. 20 mA	N/A
Battery life		N/A	+/- 3 years
Battery type		N/A	3 Volt Lithium battery
Maximum range	m		10
Operation range	°C		0~50
Communication	Type		RF
	Frequency	MHz	868.3

- › Room temperature is sent to the indoor unit every 90 seconds or if the temperature difference is 0.2°C or larger.

KRCS\*

# Wired room temperature sensor

- › Accurate temperature measurement, thanks to flexible placement of the sensor
- › specific model code for each indoor unit can be found in the option tables











## Specifications

Dimensions (HxW)	mm	60 x 50
Weight	g	300
Length of branch wiring	m	12

## ADAPTER PCBs



### Simple solutions for unique requirements Concept and benefits

- › Low cost option to satisfy simple control requirements
- › Deployed on single or multiple units

			Connectable to:		
			Split	Sky Air	VRV
	<b>(E)KRP1B*</b> adapter for wiring	<ul style="list-style-type: none"> <li>› Facilitates integration of auxiliary heating apparatus, humidifiers, fans, damper</li> <li>› Powered by and installed at the indoor unit</li> </ul>		●	●
	<b>KRP2A*/KRP4A*</b> Wiring adapter for electrical appendices	<ul style="list-style-type: none"> <li>› Remotely start and stop up to 16 indoor units (1 group) (KRP4A* via P1 P2)</li> <li>› Remotely start and stop up to 128 indoor units (64 groups) (KRP2A* via F1 F2)</li> <li>› Alarm indication/ fire shut down</li> <li>› Remote temperature setpoint adjustment</li> <li>› Cannot be used in combination with a central controller</li> </ul>		●	●
	<b>SB.KRP58M2</b>	<ul style="list-style-type: none"> <li>› Low noise and demand control option for RZAG-N* and RZASG-M* series.</li> <li>› Obligatory mounted plate EKMKA2 needs to be ordered separately</li> </ul>		●	
	<b>KRP58M51</b>	<ul style="list-style-type: none"> <li>› Low noise and demand control option for RZA-D series.</li> <li>› Includes obligatory mounted plate EKMKA3</li> <li>› Obligatory mounting plate EKMKA3 needs to be ordered separately</li> </ul>		●	
	<b>DTA104A*</b> Outdoor Unit External Control Adapter	<ul style="list-style-type: none"> <li>› Individual or simultaneous control of VRV system operating mode</li> <li>› Demand control of individual or multiple systems</li> <li>› Low noise option for individual or multiple systems</li> </ul>			●
	<b>DCS302A52-9</b> Unification adapter for computerized control	<ul style="list-style-type: none"> <li>› Enables unified display (operation/malfunction) and unified control (ON/OFF) from BMS system</li> <li>› Must be used together with Intelligent Touch Controller or intelligent Touch Manager</li> <li>› Cannot be combined with KRP2/4*</li> <li>› Can be used for all VRV indoor models</li> </ul>			●
	<b>KRP928*</b> Interface adapter for DIII-net	<ul style="list-style-type: none"> <li>› Allows integration of split units to Daikin central controls</li> </ul>	●		
	<b>KRP980*</b> Adapter for split units without an S21 port	<ul style="list-style-type: none"> <li>› Connect a wired remote control</li> <li>› Connect to Daikin central controls</li> <li>› Allow external contact</li> </ul>	●		
	<b>KRP413*</b> Wiring adapter normal open contact / normal open pulse contact	<ul style="list-style-type: none"> <li>› Switch off auto restart after power failure</li> <li>› Indication of operation mode / error</li> <li>› Remotely start /stop</li> <li>› Remotely change operation mode</li> <li>› Remotely change fan speed</li> </ul>	●		

Some adapters require an installation box, refer to the option lists for more information

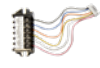
## Accessories

<b>EKRORO</b>		<ul style="list-style-type: none"> <li>› External ON/OFF or forced off</li> <li>› Example: door or window contact</li> </ul>
<b>EKRORO 3</b>		<ul style="list-style-type: none"> <li>› External ON/OFF or forced off</li> <li>› F1/F2 contact</li> <li>› Example: door or window contact</li> </ul>
<b>KRC19-26A</b>		<ul style="list-style-type: none"> <li>› Mechanical cool/heat selector</li> <li>› Allows switching over an entire system between cooling/heating/fan only</li> <li>› Connects to the A/B/C terminals of the unit</li> </ul>
<b>BRP2A81</b>		<ul style="list-style-type: none"> <li>› Cool/heat selector PCB</li> <li>› Required to connect KRC19-26A to a VRV IV outdoor unit</li> </ul>



# Options

## & accessories

Sky Air	142
Indoor units	142
Outdoor units	144
Rooftops	145
Ventilation	146
Control systems	148

		FCAHG-H FCAG-B	FFA-A9	FDXM-F9	FBA-A(9)
<b>INDOOR UNITS</b>					
<b>Panels</b>	Decoration panel (obligatory for cassette units, optional for others)	Standard panels: BYCQ140E (white) / BYCQ140EW (full white)(1) / BYCQ140EB (black) Auto cleaning panels(2) (4): BYCQ140EGF (white) / BYCQ140EGFB (black) Designer panels: BYCQ140EP (white) / BYCQ140EPB (black)	BYFQ60CW (white) BYFQ60CS (silver) BYFQ60B3 (standard)		
	Panel spacer for reducing required installation height		KDBQ44B60 (only for standard panel)		
	Sealing kit for 3- or 2-directional air discharge	KDBHQ56B140 (11)	DBBHQ44C60		
	Sensor kit	BRYQ140B (white) BRYQ140BB (black) BRYQ140C (white designer) BRYQ140CB (black designer)	BRYQ60AW (white)(9) BRYQ60AS (silver)(9)		
<b>Individual control systems</b>	Onecta app	BRP069C82 (14) (18)	BRP069C81 (18)	BRP069C81	BRP069C81 (18)
	Infrared remote control (incl. receiver)	BRC7FA532F (white) (11) (16) BRC7FA532FB (black) (11) (16) BRC7FB532F (designer white) (11) (16) BRC7FB532FB (designer black) (11) (16)	BRC7EB530W for standard panel (5)(6) BRC7F530W for white panel (5)(6) BRC7F530S - for silver panel (5)(6)	BRC4C65	BRC4C65
	<b>Madoka</b> BRC1H519W7 (9) (White) / BRC1H519S7 (9) (Silver) / BRC1K519K7 (9) (Black) User-friendly wired remote controller with premium design	●	●	●	●
	BRC1E53A/B/C (3) (13) - Wired remote controller with full-text interface and back-light	●	●	●	●
<b>Centralised control systems</b>	DIII-net connection - for connection to centralized control	standard	standard	standard	standard
	DCC601A51 - intelligent Tablet Controller	●	●	●	●
	DCS601C51 (13) - intelligent Touch Controller	●	●	●	●
	DCS302C51 (13) - Central remote controller	●	●	●	●
	DCS301B51 (13) - Unified ON/OFF controller	●	●	●	●
<b>Building Management System &amp; Standard protocol interfaces for individual control</b>	RTD-NET - Modbus interface for monitoring and control	●	●	●	●
	RTD-10 - Modbus interface for infrastructure cooling	●	●	●	●
	RTD-20 - Modbus interface for retail	●	●	●	●
	RTD-HO - Modbus interface for hotel	●	●	●	●
	KLIC-DI - KNX Interface	●	●	●	●
	DCM601A51 - intelligent Touch Manager	●	●	●	●
	EKMBOX - Modbus interface	●	●	●	●
	DCM010A51 - Daikin PMS interface	●	●	●	●
	DMS502A51 - BACnet Interface	●	●	●	●
	DMS504B51 - LonWorks Interface	●	●	●	●
<b>Filters</b>	Replacement long-life filter, non-woven type	KAF5511D160	KAF441C60		
	Auto cleaning filter	see deco panel		BAE20A62 (25 - 35) BAE20A102 (50 - 60)	
	Filter chamber				
<b>Wiring and sensors</b>	Extension wire auto cleaning panel (required when auto cleaning panel AND Onecta app are both installed)				
	KRCS - External wired temperature sensor	KRCS01-7B	KRCS01-4	KRCS01-4	KRCS01-4
	K.RSS - External wireless temperature sensor	SB.K.RSS_RFC (EKEWTS-C-2 + K.RSS)	●		●
<b>Wiring and sensors Adapters</b>	Wiring adapter with 2 output signals (compressor/ Error, Fan output)	KRP1BA58 (10)(11)	KRP1B57 (10)	KRP1B56 (10)	
	Adapter (interlock for fresh air intake fan)				KRP1B54
	Adapter with 4 output signals (compressor / Error, Fan, Aux, heater, Humidifier output)	EKRPI1C12 (10)(11)	EKRPIB2		EKRPIB2 (7)
	Adapter for centralised external monitoring/control (controls 1 entire DIII-NET system)			KRP2A53 (10)	KRP2A51 (7)(10)
	Adapter for external monitoring/control via dry contacts and setpoint control via 0-140 Ω	KRP4A53 (10)(11) (17)	KRP4A51	KRP4A54-9	KRP4A52 (10)
	Adapter for keycard and/or window contact connection (in combination with BRC1H*, BRC1/2/3E* only)	BRP7A53	BRP7A53	BRP7A54 (10)	BRP7A51 (12)
	Installation box/Mounting plate for adapter PCBs (when there is no space in the switchbox, an installation box is required)	KRP1H98A (11)	KRP4A93	KRP1BB101	KRP1B101/KRP1BB101
	Wiring kit for Remote ON/OFF or Forced OFF	standard	standard	standard	standard
<b>Others</b>	Drain pump kit				
	Multi zoning kit (for detailed model code overview refer to multizoning argue card in this catalogue)			2 dampers (25 - 35) 3 dampers (35 - 50) 4 dampers (35 - 71) 5 dampers (60 - 140) 6 dampers (60 - 140) 7 dampers (100 - 140) 8 dampers (100 - 140)	2 dampers (35 - 50) 3 dampers (35 - 50) 4 dampers (35 - 71) 5 dampers (60 - 140) 6 dampers (60 - 140) 7 dampers (100 - 140) 8 dampers (100 - 140)
	L-type piping kit (upward direction)				
	Fresh air intake kit (direct installation type)	KDDP55C160-1 (chamber) KDDP55D160-2 (diffuser) (11)	KDDQ44XA60		
	Air discharge adapter for round duct				KDAP25A56A (35-50) KDAP25A71A (60-71) KDAP25A140A (100-140)

- Dirt formation is more easily visible on white insulation. It is recommended not to install this option in environments with a high concentration of dirt.
- To be able to control option BYCQ140EG(F)/EGFB, controller BRC1H\*, BRC1E\* is needed. These options cannot be combined with RXYSQ\*, multi or non-inverter split units
- Included languages are:  
A: English, German, French, Dutch, Spanish, Italian and Portuguese  
B: English, Bulgarian, Croatian, Czech, Hungarian, Romanian and Slovenian  
C: English, Greek, Polish, Russian, Albanian, Slovak and Turkish
- The option is intended exclusively for use in fine dust environments (e.g. Clothing shops). Do not use it in environments that are greasy or have high humidity. F = finer mesh
- Sensing function is not available
- Individual flap control function not available
- If installing an electrical heater, an option PCB for external electrical heater (EKRPIB2) for each indoor unit is required. These options require mounting plate KRP4A96. Electrical heaters and humidifiers are field-supplied. Do not install them inside the equipment.
- Mounting plate KRP4A96 is required for these options. Maximum 2 option PCB's can be mounted.



		R-32				
		RZAG-A	RZAG-NV1/NY1	RZASG-MV1/MY1	RZA-D	AZAS-MV1/MY1
Refrigerant branch piping (3)	for twin		KHRQ58T	KHRQ58T	KHRQ22M20TA	
	for triple		KHRQ58H (100 - 140)	KHRQ58H (100 - 140)	KHRQ250H7	
	for double twin		KHRQ58T (3x) (125 - 140)	KHRQ58T (3x) (125 - 140)	KHRQ22M20TA (x3)	
	Asymmetric combinations piping reducer	ASYCPIR (see table below)				
<b>Demand adapter kit</b>			SB.KRP58M52 (1)	SB.KRP58M52 (1)	KRP58M51 (2)	
<b>Bottom plate heater</b>			EKBPH140N		EKBPH250D	
<b>Sound enclosure</b>			EKLN140A		EKLN140A	

- (1) Contains KRP58M1 and obligatory mounting kit EKMKA2
- (2) To mount KRP58M51, an additional mounting kit (EKMKA3) needs to be used (obligatory)
- (3) For metric size refrigerant branching contact your local sales representative

**Option for asymmetric combination (Asymmetric combinations piping reducer)**

ASYCPIR		Liquid	GAS	
		ø 9.52 → ø 6.4	ø 12.7 → ø 9.52	ø 15.9 → ø 12.7
RZAG35A	FDXM50F9		•	
	FFA50A9		•	
	FBA50A9		•	
	FCAG50B		•	
	FNA50A9		•	
	FTXM50R		•	
	FHA50A9		•	
RZAG60A	FBA71A9	•		
	FCAG71B	•		•
	FTXM71R			•
	FHA71A9	•		•

Example of using:

- 1) Connecting a pipe of ø12.7 to a gas pipe connection port for ø15.9:

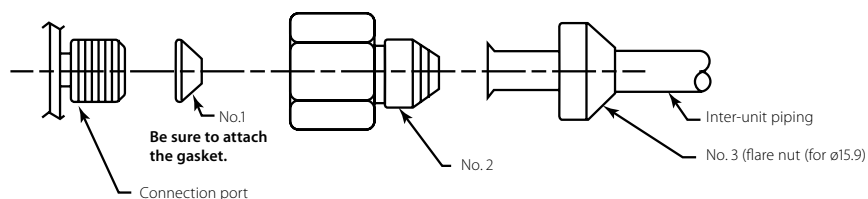



## Field applied accessories for Made-To-Stock units

	BASE series (UATYA-BBAY1)					FC2 series (UATYA-BFC2Y1)					FC3 series (UATYA-BFC3Y1)								
	25-30	40-50	60-70	80-120	140-190	25-30	40-50	60-70	80-90	100-120	140-190	25-30	40-50	60-70	80-100	110-120	140-180	190	
<b>Air treatment</b>	Filter ISO Coarse 75% (G4)	2x UATYAC75A + 2x UATYAC75B (Standard for MTS)	3x UATYAC75A + 3x UATYAC75B (Standard for MTS)	6x UATYAC75B (Standard for MTS)	12x UATYAC75C (Standard for MTS)	12x UATYAC75C (Standard for MTS)	2x UATYAC75A + 2x UATYAC75B (Standard for MTS)	3x UATYAC75A + 3x UATYAC75B (Standard for MTS)	6x UATYAC75B (Standard for MTS)	12x UATYAC75C (Standard for MTS)	12x UATYAC75C (Standard for MTS)	2x UATYAC75A + 2x UATYAC75B (Standard for MTS)	3x UATYAC75A + 3x UATYAC75B (Standard for MTS)	6x UATYAC75B (Standard for MTS)	12x UATYAC75C (Standard for MTS)	12x UATYAC75C (Standard for MTS)	12x UATYAC75C (Standard for MTS)	12x UATYAC75C (Standard for MTS)	12x UATYAC75C (Standard for MTS)
	Filter ISO ePM10 50% (M5/F5)	2x UATYAEPM1050A + 2x UATYAEPM1050B	3x UATYAEPM1050A + 3x UATYAEPM1050B	6x UATYAEPM1050B	12x UATYAEPM1050C	12x UATYAEPM1050C	2x UATYAEPM1050A + 2x UATYAEPM1050B	3x UATYAEPM1050A + 3x UATYAEPM1050B	6x UATYAEPM1050B	12x UATYAEPM1050C	12x UATYAEPM1050C	2x UATYAEPM1050A + 2x UATYAEPM1050B	3x UATYAEPM1050A + 3x UATYAEPM1050B	6x UATYAEPM1050B	12x UATYAEPM1050C	12x UATYAEPM1050C	12x UATYAEPM1050C	12x UATYAEPM1050C	12x UATYAEPM1050C
	Filter ISO ePM10 70% (M6)	2x UATYAEPM1070A + 2x UATYAEPM1070B	3x UATYAEPM1070A + 3x UATYAEPM1070B	6x UATYAEPM1070B	12x UATYAEPM1070C	12x UATYAEPM1070C	2x UATYAEPM1070A + 2x UATYAEPM1070B	3x UATYAEPM1070A + 3x UATYAEPM1070B	6x UATYAEPM1070B	12x UATYAEPM1070C	12x UATYAEPM1070C	2x UATYAEPM1070A + 2x UATYAEPM1070B	3x UATYAEPM1070A + 3x UATYAEPM1070B	6x UATYAEPM1070B	12x UATYAEPM1070C	12x UATYAEPM1070C	12x UATYAEPM1070C	12x UATYAEPM1070C	12x UATYAEPM1070C
	Rigid bag filter ISO ePM1 50% (F7)	2x UATYAEPM150A + 2x UATYAEPM150B	3x UATYAEPM150A + 3x UATYAEPM150B	6x UATYAEPM150B	12x UATYAEPM150C	12x UATYAEPM150C	2x UATYAEPM150A + 2x UATYAEPM150B	3x UATYAEPM150A + 3x UATYAEPM150B	6x UATYAEPM150B	12x UATYAEPM150C	12x UATYAEPM150C	2x UATYAEPM150A + 2x UATYAEPM150B	3x UATYAEPM150A + 3x UATYAEPM150B	6x UATYAEPM150B	12x UATYAEPM150C	12x UATYAEPM150C	12x UATYAEPM150C	12x UATYAEPM150C	12x UATYAEPM150C
	Rigid bag filter ISO ePM1 85% (F9)	2x UATYAEPM185A + 2x UATYAEPM185B	3x UATYAEPM185A + 3x UATYAEPM185B	6x UATYAEPM185B	12x UATYAEPM185C	12x UATYAEPM185C	2x UATYAEPM185A + 2x UATYAEPM185B	3x UATYAEPM185A + 3x UATYAEPM185B	6x UATYAEPM185B	12x UATYAEPM185C	12x UATYAEPM185C	2x UATYAEPM185A + 2x UATYAEPM185B	3x UATYAEPM185A + 3x UATYAEPM185B	6x UATYAEPM185B	12x UATYAEPM185C	12x UATYAEPM185C	12x UATYAEPM185C	12x UATYAEPM185C	12x UATYAEPM185C
<b>Control</b>	UATYACO2P - Duct air quality CO <sub>2</sub> probe	•	•	•	•	•	•	•	•	•	•	•	•	•	•	•	•	•	•
	UATYACAP - Constant air pressure control airflow transducer	•	•	•	•	•	•	•	•	•	•	•	•	•	•	•	•	•	•
	UATYAWRC - Remote touch screen wired remote controller	•	•	•	•	•	•	•	•	•	•	•	•	•	•	•	•	•	•
	UATYARRP - Room temperature return probe (incl. housing)	•	•	•	•	•	•	•	•	•	•	•	•	•	•	•	•	•	•
	UATYASA - Fire and smoke alarm	•	•	•	•	•	•	•	•	•	•	•	•	•	•	•	•	•	•
<b>Other</b>	Rainproof hood with anti-intrusion grille	not possible	not possible	not possible	not possible	not possible	UATYARPH3	UATYARPH4	UATYARPH5	UATYARPH6	UATYARPH6	UATYARPH6	UATYARPH6	UATYARPH6	UATYARPH6	UATYARPH6	UATYARPH6	UATYARPH6	UATYARPH6
	Rubber antivibration mounts	2x UATYAAVM1	2x UATYAAVM1	2x UATYAAVM1 + 1x UATYAAVM2	4x UATYAAVM1	2x UATYAAVM1 + 2x UATYAAVM2	2x UATYAAVM1	2x UATYAAVM1	3x UATYAAVM1 + 1x UATYAAVM2	4x UATYAAVM1	3x UATYAAVM1 + 1x UATYAAVM2	2x UATYAAVM1 + 2x UATYAAVM2	1x UATYAAVM1 + 1x UATYAAVM2	1x UATYAAVM1 + 2x UATYAAVM2	3x UATYAAVM1 + 1x UATYAAVM2	2x UATYAAVM1 + 2x UATYAAVM2	2x UATYAAVM1 + 1x UATYAAVM2	4x UATYAAVM1 + 1x UATYAAVM2	3x UATYAAVM1 + 2x UATYAAVM2
	Rubber antivibration mounts when gas heater is used	1x UATYAAVM1 + 1x UATYAAVM2	1x UATYAAVM1 + 1x UATYAAVM2	1x UATYAAVM1 + 2x UATYAAVM2	5x UATYAAVM1	5x UATYAAVM1	2x UATYAAVM1	2x UATYAAVM1	1x UATYAAVM1 + 1x UATYAAVM2	4x UATYAAVM1	5x UATYAAVM1	5x UATYAAVM1	1x UATYAAVM1 + 1x UATYAAVM2	2x UATYAAVM1 + 1x UATYAAVM2	4x UATYAAVM1	5x UATYAAVM1	4x UATYAAVM1 + 1x UATYAAVM2	3x UATYAAVM1 + 2x UATYAAVM2	3x UATYAAVM1 + 2x UATYAAVM2

## Field applied accessories for Made-To-Order units

	MTO - BASE series	MTO - FC2 series	MTO - FC3 series	MTO - RS4 series
<b>Control</b>	UATYACO2P - Duct air quality CO <sub>2</sub> probe	•	•	•
	UATYACAP - Constant air pressure control airflow transducer	•	•	•
	UATYAWRC - Remote touch screen wired remote controller	•	•	•
	UATYARRP - Room temperature return probe (incl. housing)	•	•	•
	UATYASA - Fire and smoke detector	•	•	•
<b>Other</b>	Rubber antivibration mounts	• (1)	• (1)	• (1)
	Rainproof hood with anti-intrusion grille	• (1)	• (1)	• (1)

(1) Reference code to be selected in selection software

		Heat Recovery Ventilation - Modular L (Smart)						
		ALB02LBS/RBS	ALB03LBS/RBS	ALB04,05 LBS/RBS	ALB06,07 LBS/RBS	VAM 50FC9	VAM 250FC9	VAM 350J8
Individual control systems	BRC301B61 VAM wired remote control	•	•	•	•	•	•	•
	Madoka BRC1H52W (White) / BRC1H52S (Silver) / BRC1H52K (Black) User-friendly wired remote controller with premium design	•	•	•	•	•	•	•
	BRC1E53A/B/C Wired remote control with full-text interface and back-light	•	•	•	•	•	•	•
	BRC1D52 Standard wired remote control with weekly timer	•	•	•	•	•	•	•
Centralised control systems	DCC601A51 intelligent Tablet Controller	•	•	•	•	•	•	•
	DCS601C51 intelligent Touch Controller	•	•	•	•	•	•	•
	DCS302C51 Central remote control	•	•	•	•	•	•	•
	DCS301B51 Unified ON/OFF control	•	•	•	•	•	•	•
Building Management System & Standard protocol interface	DCM601A51 intelligent Touch Manager	•	•	•	•	•	•	•
	EKMBDXB Modbus interface	•	•	•	•	•	•	•
	DMS502A51 BACnet Interface	•	•	•	•	•	•	•
	DMS504B51 LonWorks Interface	•	•	•	•	•	•	•
Filters	Coarse 55% (G4)	ALF02G4A	ALF03G4A	ALF05G4A	ALF07G4A			
	ePM <sub>10</sub> 75% (M5)	ALF02M5A	ALF03M5A	ALF05M5A	ALF07M5A			
	ePM <sub>10</sub> 70% (M6)							EKAFVJ50F6
	ePM <sub>1</sub> 50% (F7)	ALF02F7A	ALF03F7A	ALF05F7A	ALF07F7A			
	ePM <sub>1</sub> 60% (F7)							EKAFVJ50F7
	ePM <sub>1</sub> 70% (F8)							EKAFVJ50F8
	ePM <sub>1</sub> 80% (F9)	ALF02F9A	ALF03F9A	ALF05F9A	ALF07F9A			
	High efficiency filter							
	Replacement air filter							
Mechanical accessories	Rail	ALA02RLA	ALA03RLA	ALA05RLA	ALA07RLA			
	Rectangular to round duct transition	ALA02RCA	ALA03RC	ALA05RCA	ALA07RCA			
	Separate plenum							
CO <sub>2</sub> sensor	BRYMA200	BRYMA200	BRYMA200	BRYMA200			BRYMA65	
Electrical heater for pre treatment of fresh air	ALD02HEFB	ALD03HEFB	ALD05HEFB	ALD07HEFB	GSIEKA10009	GSIEKA15018	GSIEKA20024	
<b>NEW</b> DX coil for post treatment of fresh air								
Silencer (900mm depth)	ALS0290A	ALS0390A	ALS0590A	ALS0790A				
Electrical accessories	Wiring adapter for external monitoring/control (controls 1 entire system)					KRP2A51 (2)	KRP2A51	KRP2A51 (2)
	Adapter PCB for humidifier							
	Adapter PCB for third party heater					BRP4A50A	BRP4A50A	BRP4A50A (4)
	External wired temperature sensor							
	Adapter PCB Mounting plate					EKMP25VAM	EKMP25VAM	
Installation box for adaptor PCB					KRP1BB101	KRP1BB101	KRP1BB101	

Notes

- (1) Do not connect the system to DIII-net devices LONWorks interface, BACnet interface, ...; (intelligent Touch Manager, EKMBDXA are allowed)
- (2) Installation box KRP1BB101 needed
- (3) Adapter PCB mounting plate needed, applicable model can be found in the table above
- (4) 3rd party heater and 3rd party humidifier cannot be combined
- (5) Installation box KRP50-2A90 needed
- (6) Contains 1 plenum and can be used for half side of the unit (up to 4 plenums can be used on 1 unit)
- (7) Available only with optional plenum
- (8) To be combined with option BRP4A50A using external 230VAC with local supplied circuit breaker (max.3ACA)



## Individual and centralised controls

	BRCID*	BRCIE*	BRCIH*	DCS301B51	DST301B51	DCS302C51	DCS601C51
Madoka Assistant app for advanced settings			●				
Electical box KJB111A	●	●	●				
Electical box KJB212A(A) (1)	●	●		●	●		
Electical box KJB311A(A)						●	
Electical box KJB411AA							●

(1) recommended as wider (more stable mounting)

## Intelligent Tablet Controller - DCC601A51

		Intelligent Controller		
		Options for local control	Daikin Cloud Service options	Software
Wired screen for local control	AL-CCD07-VESA-1	●	-	-
Control and monitoring package		-	●	-
Remote support and diagnostics package		-	●	-
Advise and optimisation package		-	●	-
Commissioning tool		-	-	●
Software update tool		-	-	●

Daikin Cloud Service requires a subscription. Contact your local sales representative for more information

## Intelligent Touch Manager - DCM601A51

		Intelligent Manager	Daikin Cloud Service options (2)
iTM plus adapter – Allows connection of an additional 64 indoor units/groups. Up to 7 adapters can be connected	DCM601A52	•	
iTM PPD software – Allows distribution of used kWh by indoor units connected to the iTM	DCM002A51	•	
iTM HTTP interface - Allows communication to any third party controller via http interface	DCM007A51	•	
iTM Energy navigator – Energy management option	DCM008A51	•	
iTM BACnet Client option – Enables integration of third party devices to the iTM via the BACnet/IP protocol. (This is not a gateway and cannot replace DMS502A51)	DCM009A51	•	
Property Management System (PMS) interface option - Enables to connect to third party PMS systems	DCM010A51	• Oracle Opera PMS	
Monitoring package			•
Remote support and diagnostics package			•
Advise and optimisation package			•

### WAGO interface options for intelligent Touch Manager

#### Required or optional WAGO base modules

Module type	Model code	Specifications	
24 V DC power supply	787-712	100 to 240 V AC → 24 V DC, 2.5 A	Required
Communications unit (Bus coupler)	WGDCMPLR2	RS-485, Max:115.2kbps, not programmable	Required
Connector (1)	750-960		Required
Terminator module	750-600		Required
Power supply module	750-613	IN: 24 V DC, OUT: 5 V DC	Optional

#### Supported WAGO I/O modules

I/O module type	Model code	Specifications	N° of contacts
Di	750-400	No-voltage contact input	2
	750-432	Contact rating: 24 V DC / 4.5 mA*	4
	750-430	No-voltage contact input Contact rating: 24 V DC / 2.8 mA	8
Do	750-513/000-001	No-voltage contact output Contact rating: 230 V AC / 30 V DC, 2 A	2
	750-504	No-voltage contact output Contact rating: 24 V DC / 0.5 A	4
Ai	750-454		2
	750-455	Rated at 4 to 20 mA: 12-bit resolution	4
	750-479	Rated at -10 to 10 V: 13-bit resolution	2
	750-459	Rated at 0 to 10 V: 12-bit resolution	4
Ao	750-554		2
	750-555	Rated at 4 to 20 mA: 12-bit resolution	4
	750-560	Rated at -10 to 10 V: 10-bit resolution	2
	750-559	Rated at 0 to 10 V: 12-bit resolution	4
Thermistor	750-461/020-000	NTC20K thermistor	2
	750-461		2
	750-460	Pt 100/RTD	4
	750-461/000-003		2
	750-460/000-003	Pt 1000/RTD	4
	50-461/000-004	Ni 100/RTD	2
	750-461/000-005		2
	750-460/000-005	Ni1000 TK6180/RTD	4
Pi	750-638	Minimum pulse width: 1 ms	2

(1) This connector must be attached to a communications unit that is connected to the RS485 port (2-pin) of the iTM unit.

(2) To connect intelligent Touch Manager to the Daikin Cloud Service, the IoT gateway (EU.SB.5000072) and AC/DC converter (999175A) is needed.



We're here to help you!  
Online and offline



<http://daikinpromoshop.eu> 

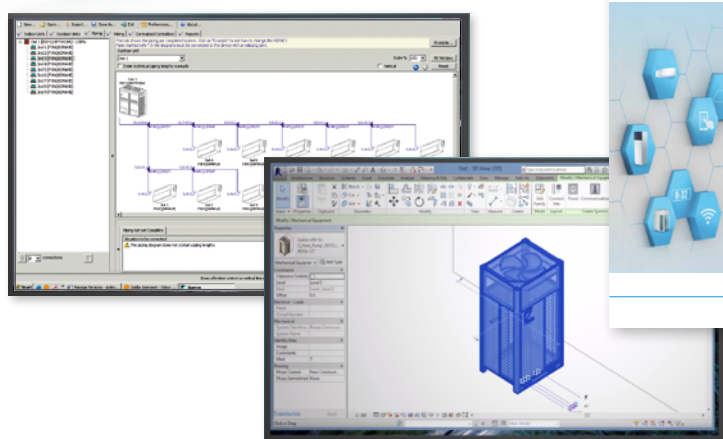

# Tools & platforms

Literature overview	152
Supporting tools, software and apps	154

# Literature overview

for professional network

Solutions catalogues:

Reference books:



**Reference catalogue**  
Daikin commercial and industrial references

213

Product profiles:

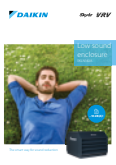

**Low sound enclosure**  
Benefits and main specifications of the Daikin low sound enclosure option

150



**VRV IV S-series**  
Main benefits, application examples and specs of VRV IV S-series product range

208



**VRV IV i-series**  
Main benefits, application examples and specs of VRV IV i-series product range

207



**Water-to-air heat pump**  
Detailed info on VRV IV W-series, application examples, technical system design background

209



**VRV S-Series**  
VRV 5  
Main benefits and specs of VRV 5

210

Focus topics:



**Replacement Technology**  
Benefits of VRV replacement technology

214



**Infrastructure cooling**  
Clear installer benefits why to choose Daikin for infrastructure cooling

140



**F-gas regulation**  
Details on the F-gas regulation and how Daikin is prepared for the future HVAC-R market

605

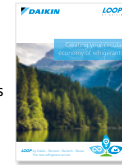

**LooP by Daikin**  
Detailed info on the LooP by Daikin circular economy program

226

Product flyers:



**Mini Sky Air Alpha-series**  
RZAG-A mini Sky Air Alpha-series  
Main benefits and specs of RZAG-A series

146



**Low height Sky Air Alpha-series**  
RZAG-N\* Sky Air Alpha-series  
Main benefits and specs of the low height RZAG-N\*

147



**Low height large Sky Air Advance-series**  
RZA-D Sky Air Advance-series  
Main benefits and specs of the low height RZA-D\* series

148

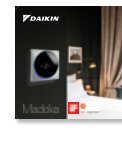

**Madoka**  
Detailed info on BRC1H\* remote control

306

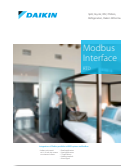

**RTD modbus interface**  
Detailed info on RTD controls and applications

308

Product catalogues:



**Sky Air Catalogue**  
Detailed technical information & benefits on Sky Air

100



**VRV Catalogue**  
Detailed technical information & benefits of the VRV total solution

200



**Ventilation Catalogue**  
Detailed info on Ventilation products

203



for your customers

Solutions catalogues:



**Commercial Solutions**  
Daikin offers solutions for commercial applications

100



**BREEAM catalogue**  
Clear building owner/investor benefits why to choose Daikin for a BREEAM project

216



**LEED catalogue**  
Clear building owner/investor benefits why to choose Daikin for a LEED project

217



**Hotel Solutions**  
Clear building owner/investor benefits why to choose Daikin for a hotel

218

Reference books:



**Success Case study**  
Vanderwalk hotel case  
In depth info on the VRV total solution at a Vanderwalk hotel

219

Product profiles:



**Intelligent Touch Manager**  
Detailed benefits of Intelligent Touch Manager

302



**Intelligent Tablet Controller**  
Detailed benefits of Intelligent Tablet Controller

303



**Daikin Cloud Service**  
Details on the Daikin Cloud connection

542

Focus topics:



Technical documentation:

Download all technical documentation such as engineering data-books, selection software, installation and operation manuals and service manuals directly from our business portal: [my.daikin.eu](http://my.daikin.eu)

# Supporting tools, software and apps

[www.daikineurope.com/  
support-and-manuals/  
software-downloads](http://www.daikineurope.com/support-and-manuals/software-downloads)



## Software

### Ventilation Xpress

Selection tool for ventilation devices (VAM, VKM). The selection is based on given supply/extract airflows (including fresh up and given ESP of supply/extract ducting:

- › Determines size of electrical heaters
- › Visualisation of psychrometric chart
- › Visualisation of selected configuration
- › Required field settings mentioned in the report

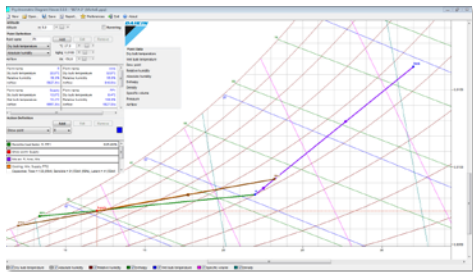

### Rooftop selection software

- › Easy selection of the correction unit and options based on location conditions
- › Direct availability of technical drawings
- › [Rooftop.daikin.eu](http://Rooftop.daikin.eu)

### Webbased ASTRA selection for air handling units

A powerful tool to select the right Air Handling Units for your needs.

- › 3D interface
- › quick selection procedures
- › new print-out possibilities and report shapes



### WAGO selection tool

The WAGO Selection Tool is specifically designed to select the optimal WAGO I/O system for your needs.

- › Easy selection of WAGO materials
- › Material list creation
- › Time saving
  - Includes wiring schemes
  - Contains commissioning/preset data for



## Plugins and third-party software tools

### Building Information Modelling (BIM) support

- › BIM improves efficiency of design and build phase
- › Daikin is among the first to supply a full library of BIM objects for its commercial product range

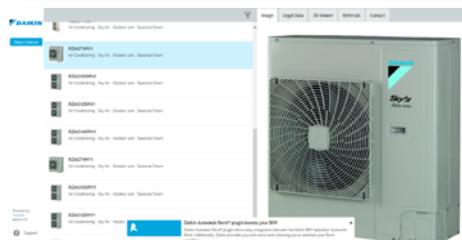

[daikin.eu/BIM](http://daikin.eu/BIM)



## Energy simulation and design aid tools

### Psychrometrics diagram

- › The Psychrometrics Diagram Viewer demonstrates the changing properties of moist air.
- › With this tool, users can choose two points with specific conditions, plot them on the diagram and select actions to change the conditions, i.e. heat, cool and mix air.

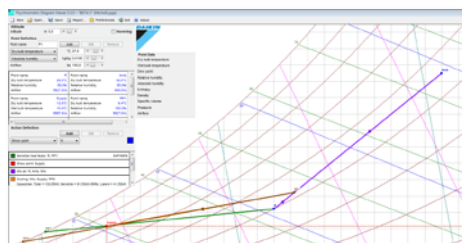

## Service tools

### Error code app

Quickly know the meaning of fault codes, for each product family and the potential cause



### D-Checker

D-checker is a software application used to record and monitor operation data of Daikin applied, split, Multi-split, Sky-air units, Daikin Altherma LT, ground source heat pump, Hybrid, ZEAS, Conveni-pack & R410A Booster unit

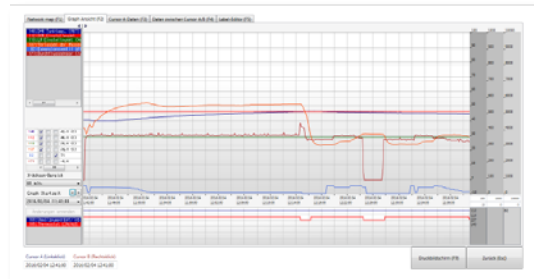

### Bluetooth adaptor

Monitoring of Split, Sky Air and VRV data via any bluetooth device

- › No need to access the outdoor unit
  - Connects with D-Checker software (for laptops)
  - Connects with monitoring app (for tablets or smartphones)

Diagnosis of the Bluetooth system possible:

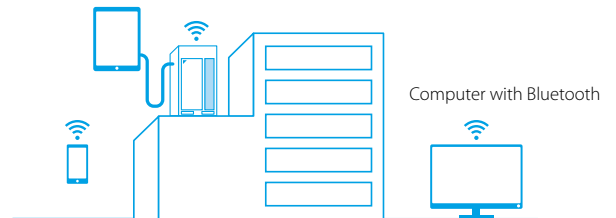

## Online support

### Business portal

- › Experience our new extranet that thinks with you at [my.daikin.eu](http://my.daikin.eu)
- › Find information in seconds via a powerful search
- › Customise the options so you see only info relevant for you
- › Access via mobile device or desktop

[my.daikin.eu](http://my.daikin.eu)



## Internet

Find our solution for different applications:

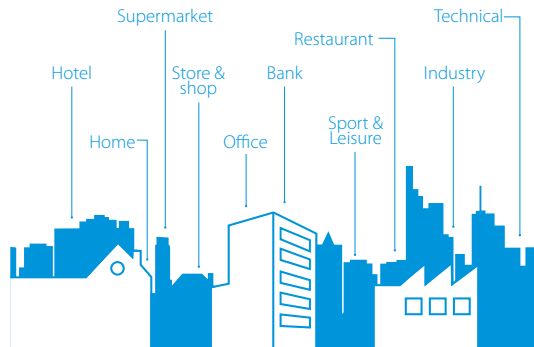

- › Get more commercial details on our flagship products via our dedicated minisites
- › See our references



[daikineurope.com/references](http://daikineurope.com/references)



# Europe's energy label

To enable consumers to compare and make purchasing decisions based on uniform labelling criteria, Europe has introduced energy labels. The previous European energy label for air conditioners, introduced in 1992, did its job for the time. In 2013, Europe introduced a seasonal energy label. This label allows end users to make even more informed choices, since seasonal efficiency reflects air conditioner efficiency over an entire season.

The energy label includes multiple classifications from A+++ to D, reflected in colour shadings ranging from dark green (most energy efficient) to red (least efficient). Information on the label not only includes the seasonal efficiency ratings for heating (SCOP) and cooling (SEER), but also annual energy consumption and noise levels.

## The label more in detail

All energy efficiency classifications mentioned in this catalogue are within the range A+++ to D

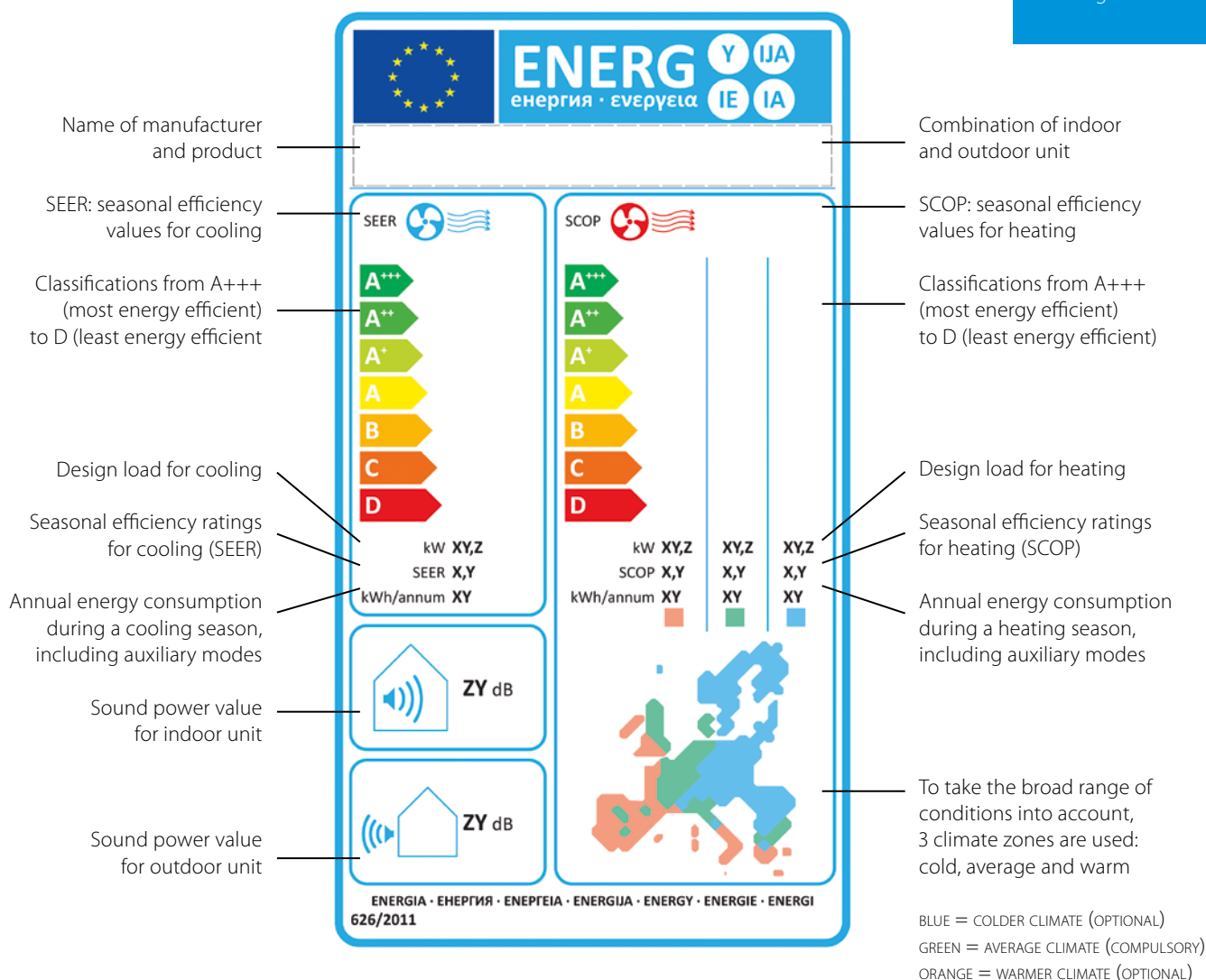

# Measuring conditions

## Power supply

T1	=	3~, 220V, 50Hz
V1	=	1~, 220-240V, 50Hz
VE	=	1~, 220-240V/220V, 50Hz/60Hz*
V3	=	1~, 230V, 50Hz
VM	=	1~, 220~240V/220~230V, 50Hz/60Hz
W1	=	3N~, 400V, 50Hz
Y1	=	3~, 400V, 50Hz

\* For VE power supply only 1~, 220-240V, 50Hz data is displayed in this catalogue.

## Conversion table refrigerant piping

inch	mm
1/4"	6.4 mm
3/8"	9.5 mm
1/2"	12.7 mm
5/8"	15.9 mm
3/4"	19.1 mm
7/8"	22.2 mm
1 1/8"	28.5 mm
1 3/8"	34.9 mm
1 5/8"	41.3 mm
1 3/4"	44.5 mm
2"	50.8 mm
2 1/8"	54 mm
2 5/8"	66.7 mm

## F-gas regulation

For fully/partially charged equipment: contains fluorinated greenhouse gases. Actual refrigerant charge depends on the final unit construction, details can be found on the unit labels.

For non pre-charged equipment (Chillers: split chiller (SEHVX/SERHQ), condensing units and condenserless chillers + refrigeration

(LCBKQ-AV1, JEHCCU/JEHSCU and ICU): Its functioning relies on fluorinated greenhouse gases.

## Measuring conditions

### Air conditioning

1) Nominal cooling capacities are based on:	
Indoor temperature	27°CDB/19°CWB
Outdoor temperature	35°CDB
Refrigerant piping length	7.5m - 8/5m VRV
Level difference	0m
2) Nominal heating capacities are based on:	
Indoor temperature	20°CDB
Outdoor temperature	7°CDB/6°CWB
Refrigerant piping length	7.5m - 8/5m VRV
Level difference	0m

The sound pressure level is measured via a microphone at a certain distance from the unit. It is a relative value, depending on the distance and acoustic environment (for measuring conditions: please refer to the technical databooks). The sound power level is an absolute value indicating the "power" which a sound source generates. For more detailed information please consult our technical databooks.



# Technical drawings

Indoor units	160
Outdoor units	191
Biddle air curtains	222
Ventilation units	225



# Technical drawings

# Indoor units

FCAG-B / FCAHG-H	161
FFA-A9	163
FDXM-F9	165
FBA-A(9)	168
FDA125A	173
FDA200-250A	175
ADEA-A	177
FAA-B	182
FHA-A(9)	183
FUA-A	186
FVA-A	187
FNA-A9	188





### FCAG-B / FCAHG-H WITH STANDARD PANEL

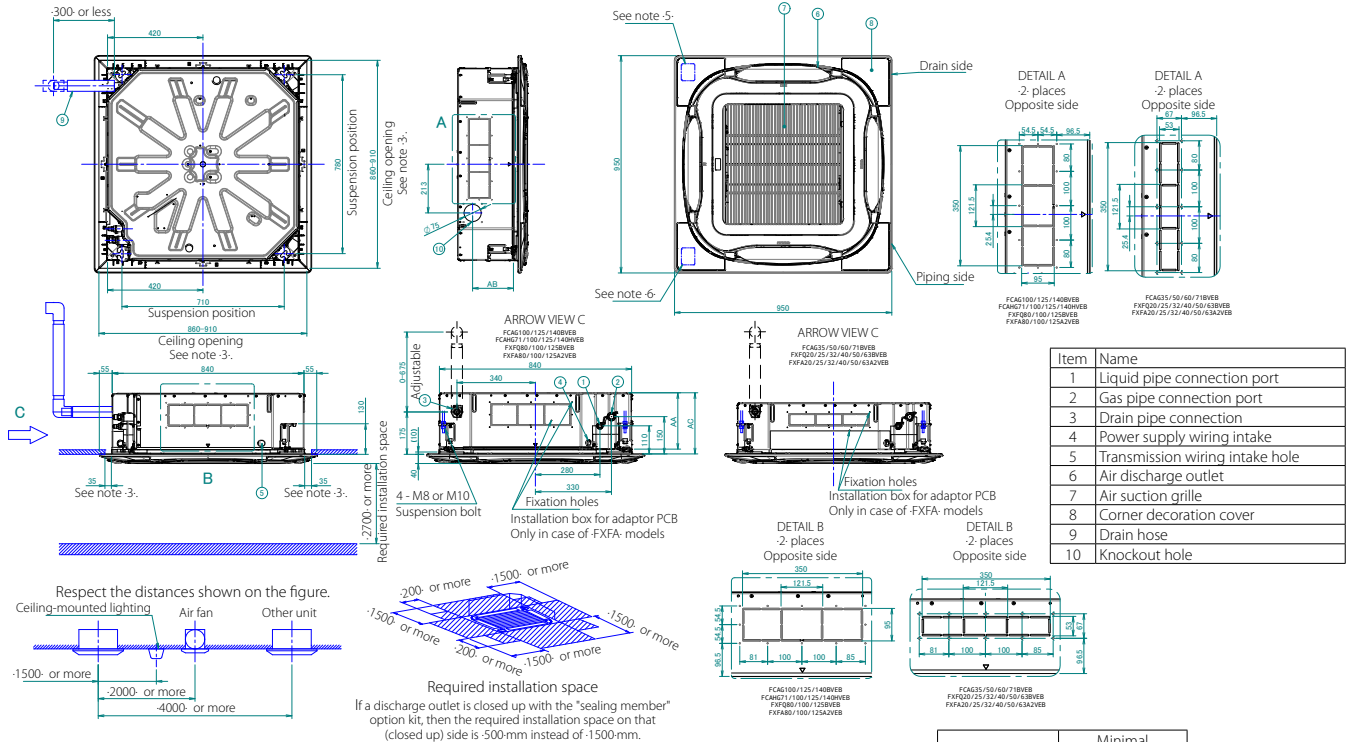

#### NOTES

- Location of nameplate  
The unit nameplate is located on the control box cover.  
The decoration panel nameplate is located on the piping-side panel frame, under the corner cover.
- When installing optional accessories, refer to their respective documentation.
- Make sure the distance between the ceiling and the cassette does not exceed 35 mm.  
The maximum ceiling opening is 910 mm.
- When the conditions in the ceiling exceed 30°C ambient temperature and 80% relative humidity, or when fresh air is inducted into the ceiling, additional insulation is required (polyethylene foam, thickness ≥ 10 mm)
- When installing a sensor kit, there will be a sensor on this location. For details, see the drawing of the sensor kit.
- When installing a wireless controller, there will be a receiver on this location. For details, see the drawing of the wireless controller.

2D121655C

### FCAG-B / FCAHG-H WITH AUTO CLEANING PANEL

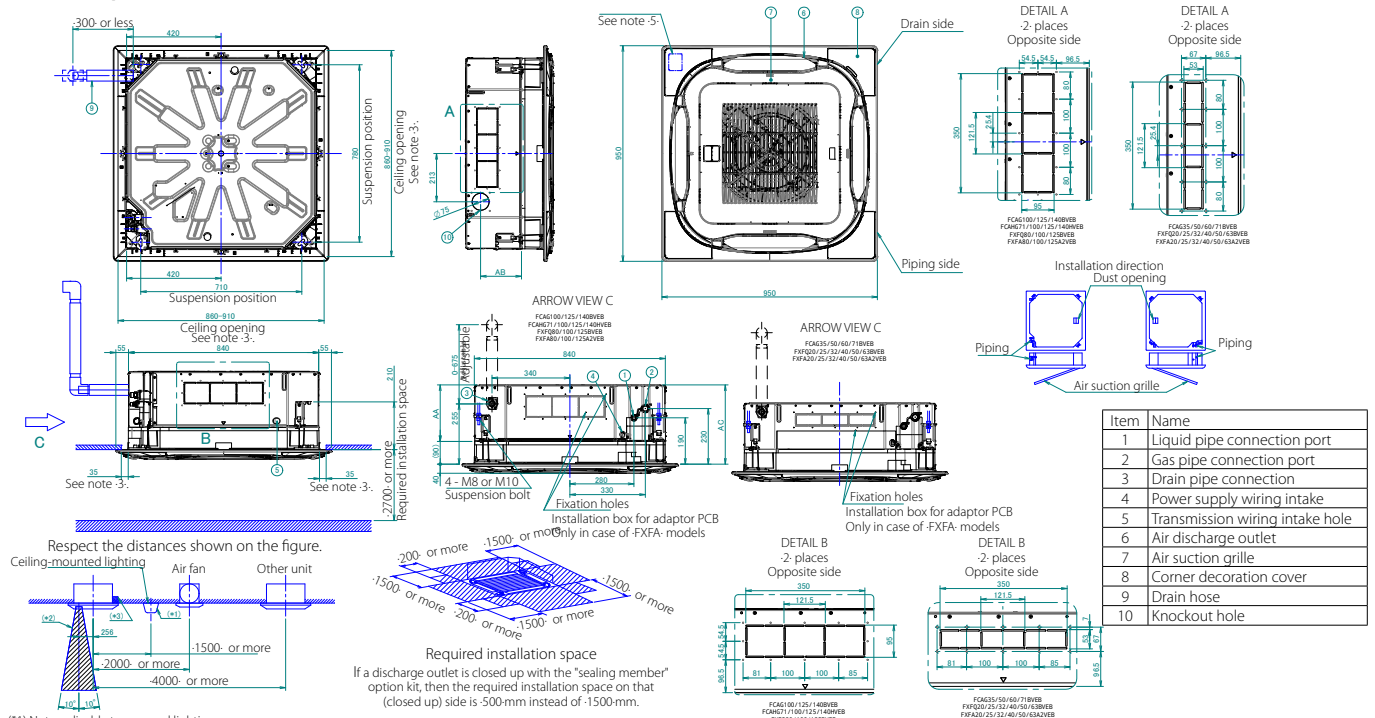

- (\*) Not applicable to recessed lighting.  
 (\*) Required space for entering with vacuum cleaner tube.  
 (\*) Make sure the decoration panel discharge outlet is not blocked.

#### NOTES

- Location of nameplate  
The unit nameplate is located on the control box cover.  
The decoration panel nameplate is located on the piping-side panel frame, under the corner cover.
- When installing optional accessories, refer to their respective documentation.
- Make sure the distance between the ceiling and the cassette does not exceed 35 mm.  
The maximum ceiling opening is 910 mm.
- When the conditions in the ceiling exceed 30°C ambient temperature and 80% relative humidity, or when fresh air is inducted into the ceiling, additional insulation is required (polyethylene foam, thickness ≥ 10 mm)
- When installing a sensor kit, there will be a sensor on this location. For details, see the drawing of the sensor kit.

2D121658C



## Detailed technical drawings

### FCAG-B / FCAHG-H - DESIGNER PANEL

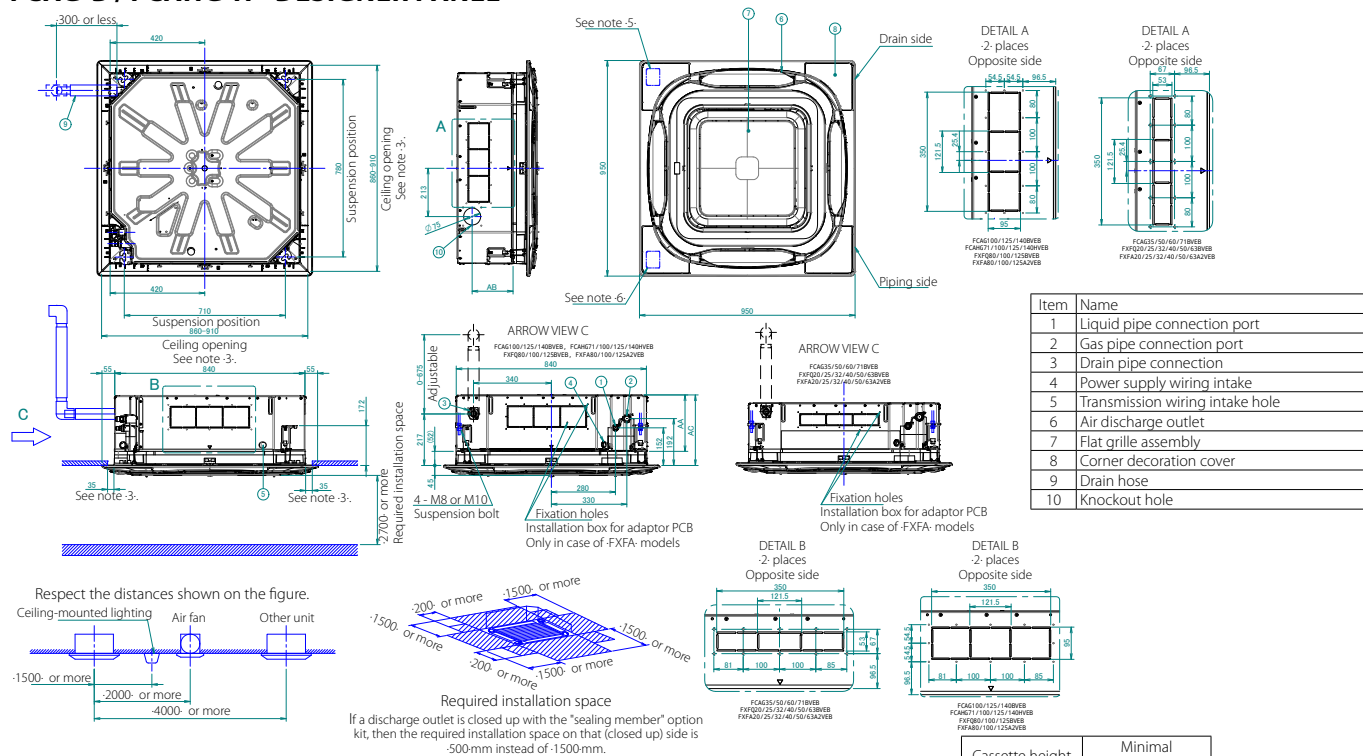

#### NOTES

- Location of nameplate  
The unit nameplate is located on the control box cover.  
The decoration panel nameplate is located on the piping-side panel frame, under the corner cover.
- When installing optional accessories, refer to their respective documentation.
- Make sure the distance between the ceiling and the cassette does not exceed 35 mm.  
The maximum ceiling opening is 910 mm.
- When the conditions in the ceiling exceed 30°C ambient temperature and 80% relative humidity, or when fresh air is inducted into the ceiling, additional insulation is required (polyethylene foam, thickness ≥ 10 mm)
- When installing a sensor kit, there will be a sensor on this location. For details, see the drawing of the sensor kit.
- When installing a wireless controller, there will be a receiver on this location. For details, see the drawing of the wireless controller.

Model	Cassette height			Minimal installation height
	AA	AB	AC	
FCAG35/50/60/71BVEB	204	139	269	2D121703C
FCAG100/125/140BVEB	246	180	311	
FCAHG71/100/125/140HVEB	288	180	353	
FXFQ20/25/32/40/50/63BVEB	204	139	269	
FXFQ80/100BVEB	246	180	311	
FXFQ125BVEB	288	180	353	
FXFA20/25/32/40/50/63A2VEB	204	139	269	
FXFA80/100A2VEB	246	180	311	
FXFA125A2VEB	288	180	353	

### FCAG-B / FCAHG-H - FRESH AIR INTAKE

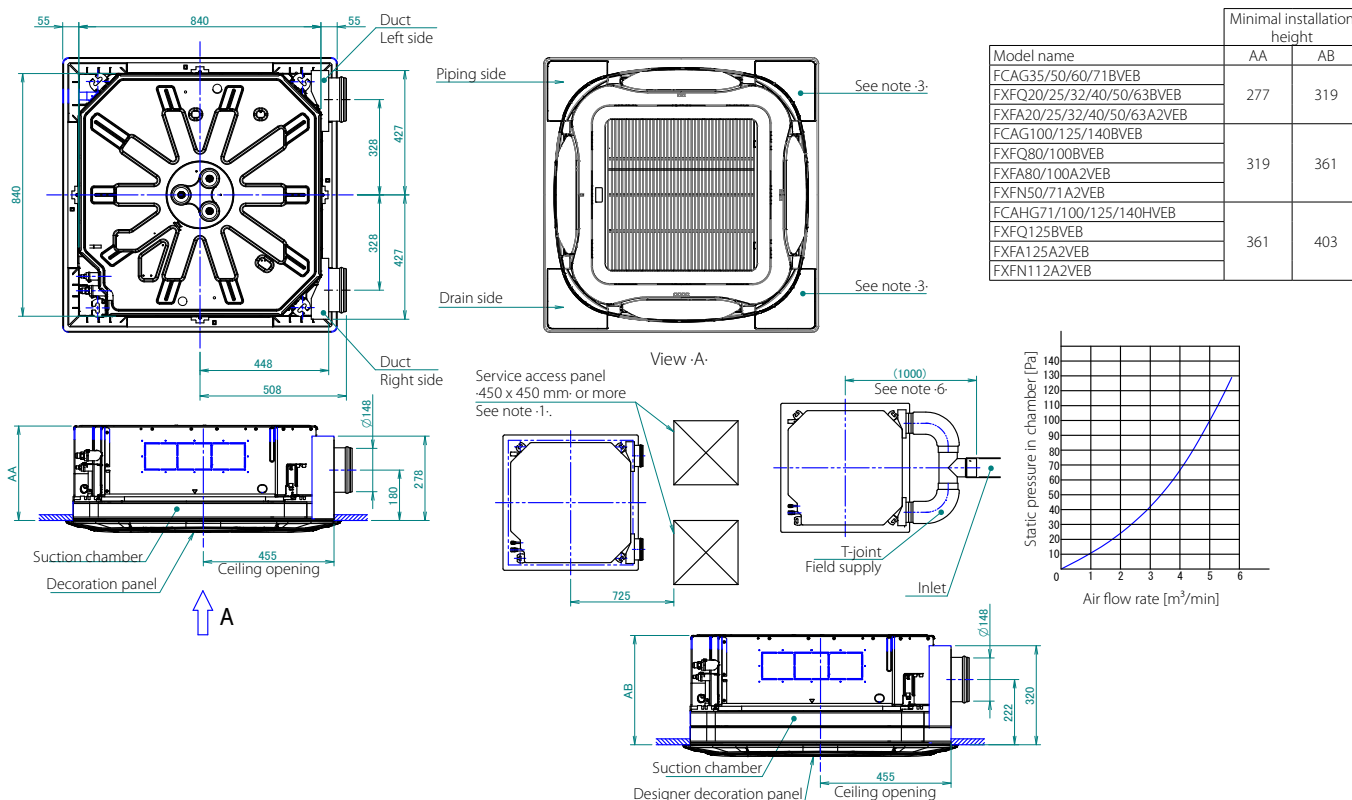

#### NOTES

- When installing a fresh air intake kit, provide a service access panel.
- Field construction
- This corner discharge outlet needs to be closed.
- When installing a duct fan, use a wiring adapter to link the duct fan to the fan of the indoor unit.
- The intake air flow rate is recommended to be ≤20% of the air flow rate at high fan speed.  
If the intake air flow rate is too large, the operating sound may increase, and the detection of the indoor unit suction temperature may be affected.
- This indicates the distance between the T-joint inlet and the indoor unit inlet when the T-tube is connected.

3D121741C



**FFA25-35A9 - FULLY FLAT PANEL**

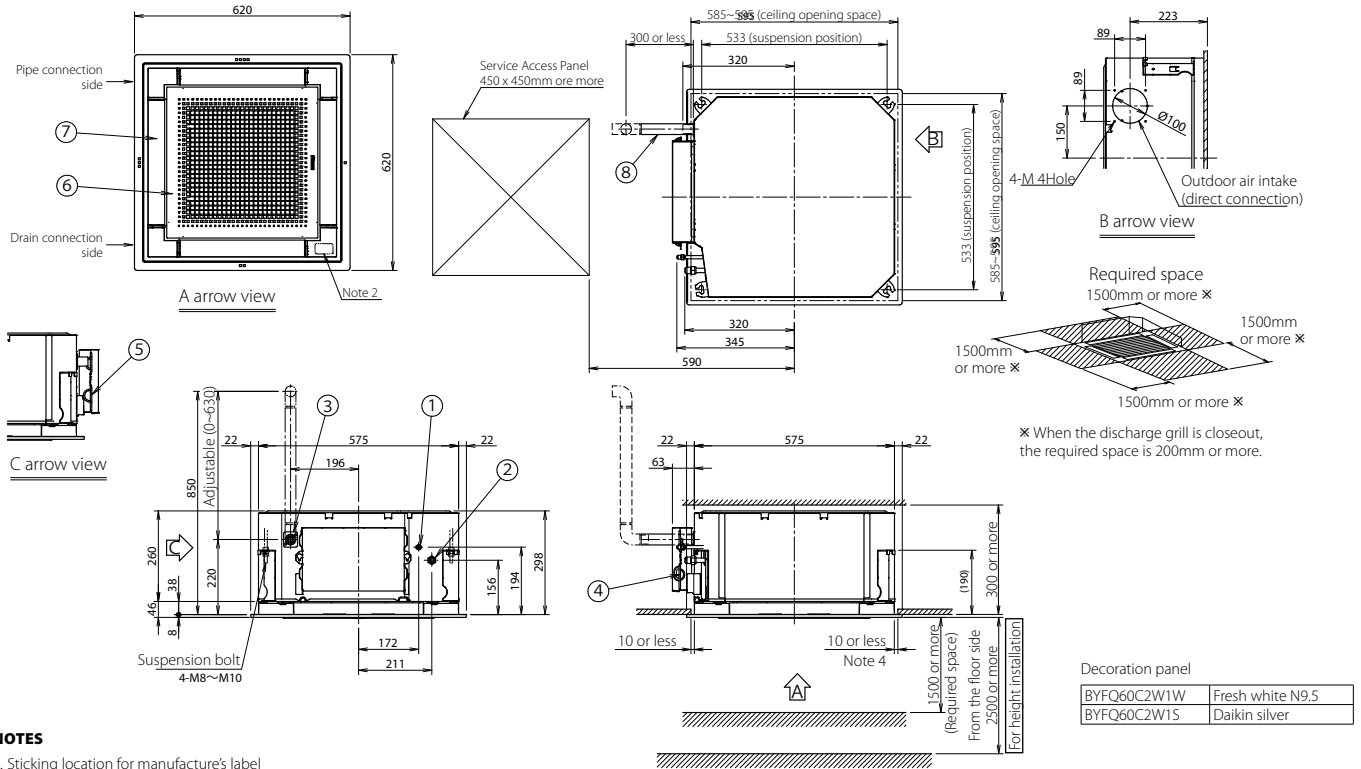

**NOTES**

- Sticking location for manufacturer's label  
Manufacturer's label for indoor unit: on the bell mouth inside suction grille  
Manufacturer's label for decoration panel: on the inner frame inside suction grille
- In case of using wireless remote controller, this position will be a signal receiver. Refer to the drawing of wireless remote controller in detail.
- When the temperature and humidity in the ceiling exceed 30°C and RH 80% or the fresh air is inducted into the ceiling or the unit continues 24 hour operation, an additional insulation (thickness 10mm or more of glasswool or polyethylene foam) is required.
- Though the installation is acceptable up to maximum of 595mm square ceiling opening, keep the clearance of 10mm or less between the main unit and the ceiling opening so that the panel overlap allowance can be ensured.

Item	Part name	Remark
1	Liquid pipe connection	ø6.4 (flare connection)
2	Gas pipe connection	ø9.5 (flare connection)
3	Drain pipe connection	VP20 (O.D. ø26)
4	Power supply connection	
5	Remote control code and control wiring connection	
6	Air discharge outlet	
7	Suction grille	
8	Drain hose (accessory)	I.D. ø25 (outlet)

**3D082433**

**FFA25-35A9 - STANDARD PANEL**

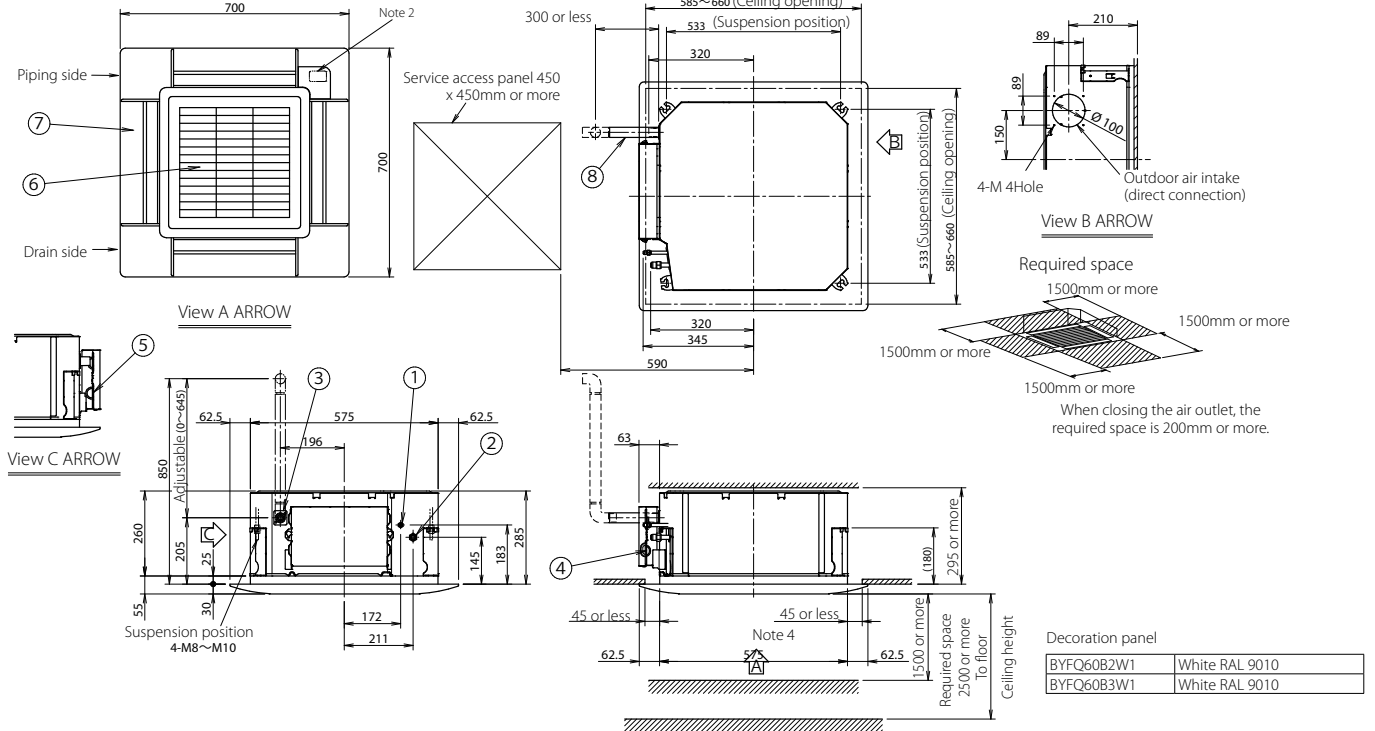

**NOTES**

- Location of nameplate  
The indoor unit nameplate is located on the bell mouth inside the suction grille.  
The decoration panel nameplate is located on the inner frame inside the suction grille.
- When installing a wireless controller, there will be a receiver on this location. For details, see the drawing of the wireless controller.
- If any of the following conditions are met, additional insulation (glass wool or polyethylene foam, thickness ≥10mm) is required:  
Ambient conditions in the ceiling ≥ 30°C and 80% relative humidity.  
Fresh air is inducted into the ceiling.  
The unit operates continuously.
- Though the installation is acceptable up to maximum 660mm square ceiling opening, keep the clearance of 45mm or less between the indoor unit and the ceiling opening, so that the panel overlap allowance can be ensured.

Item	Part name	Remark
1	Liquid pipe connection	ø 6.4 Flare connection
2	Gas pipe connection	ø 9.5 Flare connection
3	Drain pipe connection	VP20 (O.D. ø26)
4	Power supply	
5	Remote control wiring intake	
6	Air discharge grille	
7	Air suction grille	
8	Drain hose Accessory	I.D. ø25 Outlet

**3D082434C**

Detailed technical drawings

**FFA50-60A9 - FULLY FLAT PANEL**

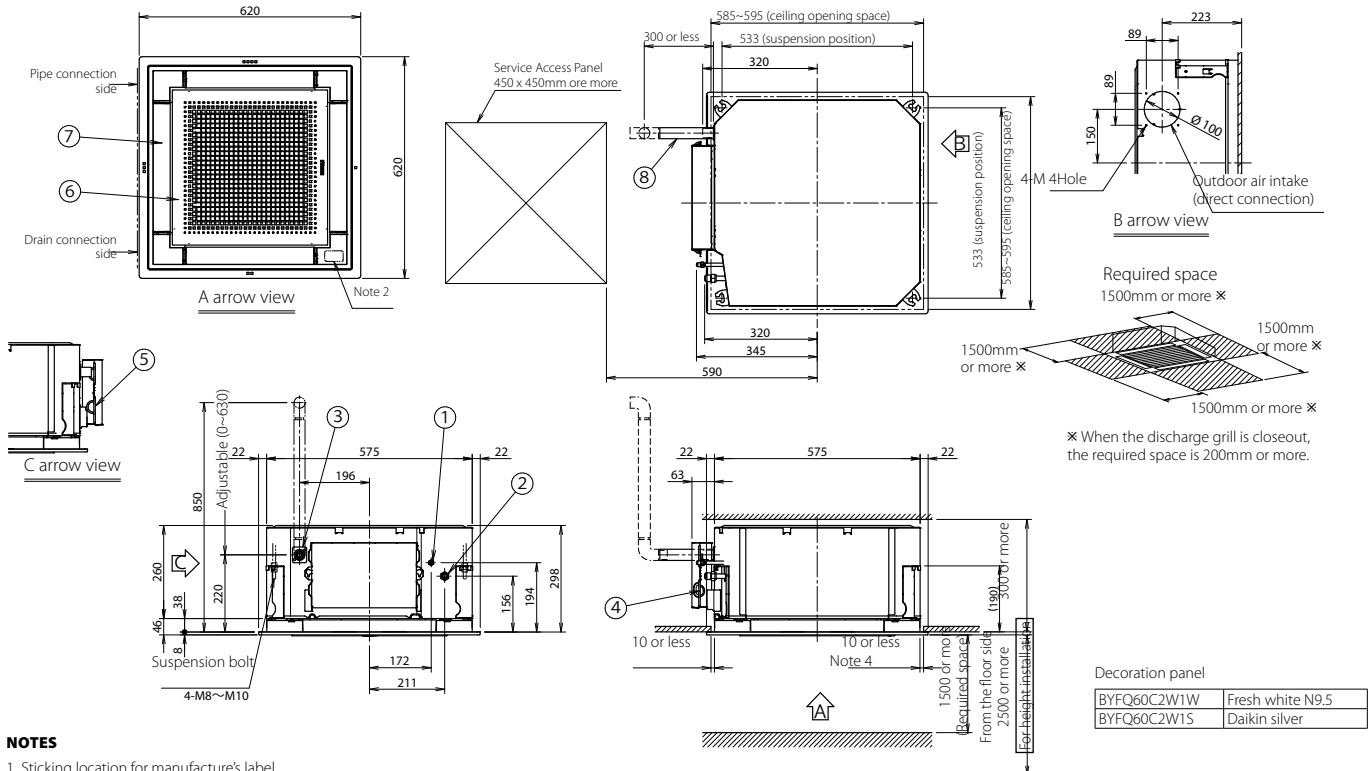

**NOTES**

1. Sticking location for manufacturer's label  
 Manufacturer's label for indoor unit: on the bell mouth inside suction grille  
 Manufacturer's label for decoration panel: on the inner frame inside suction grille
2. In case of using wireless remote controller, this position will be a signal receiver. Refer to the drawing of wireless remote controller in detail.
3. When the temperature and humidity in the ceiling exceed 30°C and RH 80% or the fresh air is inducted into the ceiling or the unit continues 24 hour operation, an additional insulation (thickness 10mm or more of glasswool or polyethylene foam) is required.
4. Though the installation is acceptable up to maximum of 595mm square ceiling opening, keep the clearance of 10mm or less between the main unit and the ceiling opening so that the panel overlap allowance can be ensured.

Item	Part name	Remark
1	Liquid pipe connection	ø6.4 (flare connection)
2	Gas pipe connection	ø12.7 (flare connection)
3	Drain pipe connection	VP20(O.D. ø26)
4	Power supply connection	
5	Remote control code and control wiring connection	
6	Air discharge outlet	
7	Suction grille	
8	Drain hose (accessory)	I.D. ø25 (outlet)

**3D082052**

**FFA50-60A9 - STANDARD PANEL**

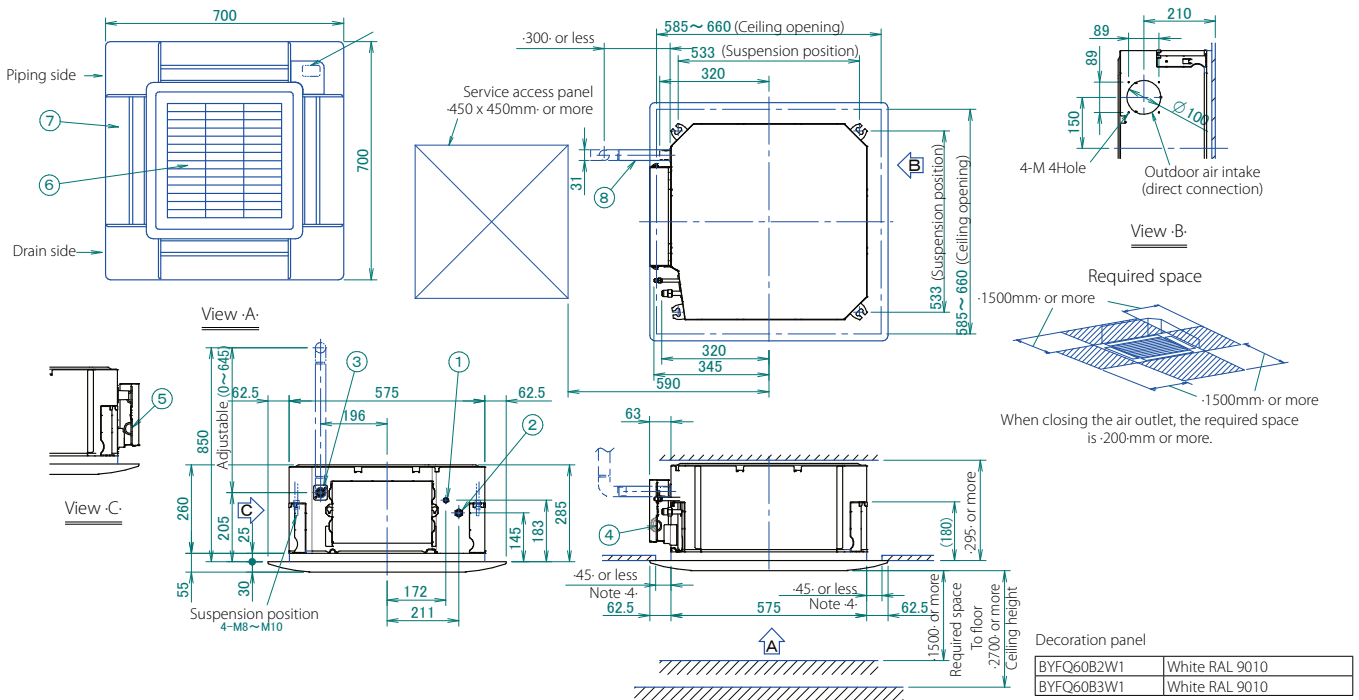

**NOTES**

1. Location of nameplate  
 The indoor unit nameplate is located on the bell mouth inside the suction grille.  
 The decoration panel nameplate is located on the inner frame inside the suction grille.
2. When installing a wireless controller, there will be a receiver on this location. For details, see the drawing of the wireless controller.
3. If any of the following conditions are met, additional insulation (glass wool or polyethylene foam, thickness ≥10mm) is required:  
 Ambient conditions in the ceiling ≥ 30°C and 80% relative humidity.  
 Fresh air is inducted into the ceiling.  
 The unit operates continuously.
4. Though the installation is acceptable up to maximum 660mm square ceiling opening, keep the clearance of 45mm or less between the indoor unit and the ceiling opening, so that the panel overlap allowance can be ensured.

Item	Part name	Remark
1	Liquid pipe connection	Ø 6.4 Flare connection
2	Gas pipe connection	Ø 12.7 Flare connection
3	Drain pipe connection	VP20(O.D. Ø26)
4	Power supply	
5	Remote control wiring intake	
6	Air discharge grille	
7	Air suction grille	
8	Drain hose Accessory	I.D. Ø25 Outlet

**3D082161C**

**FDXM25-35F9**

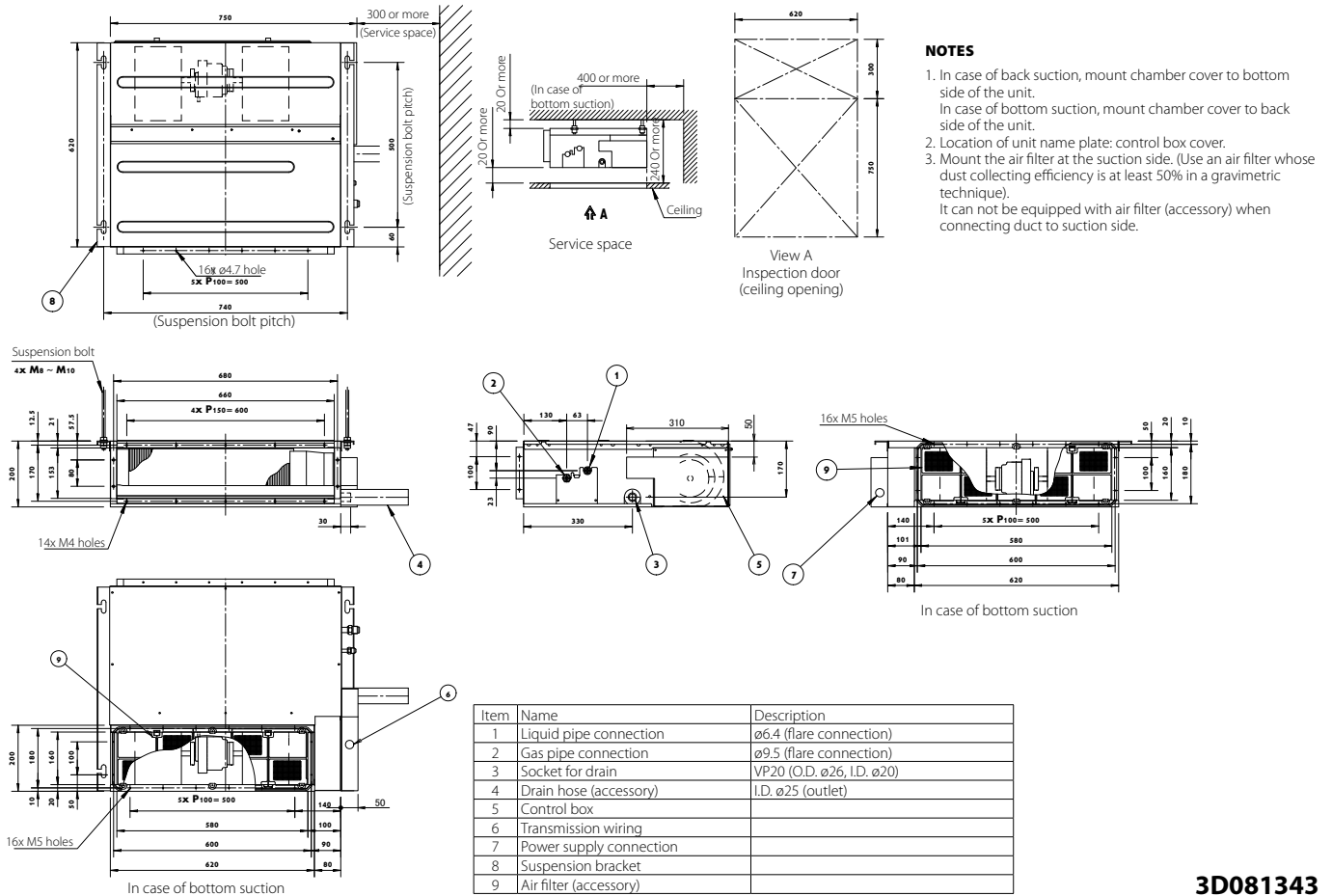

**3D081343**

**FDXM50-60F9**

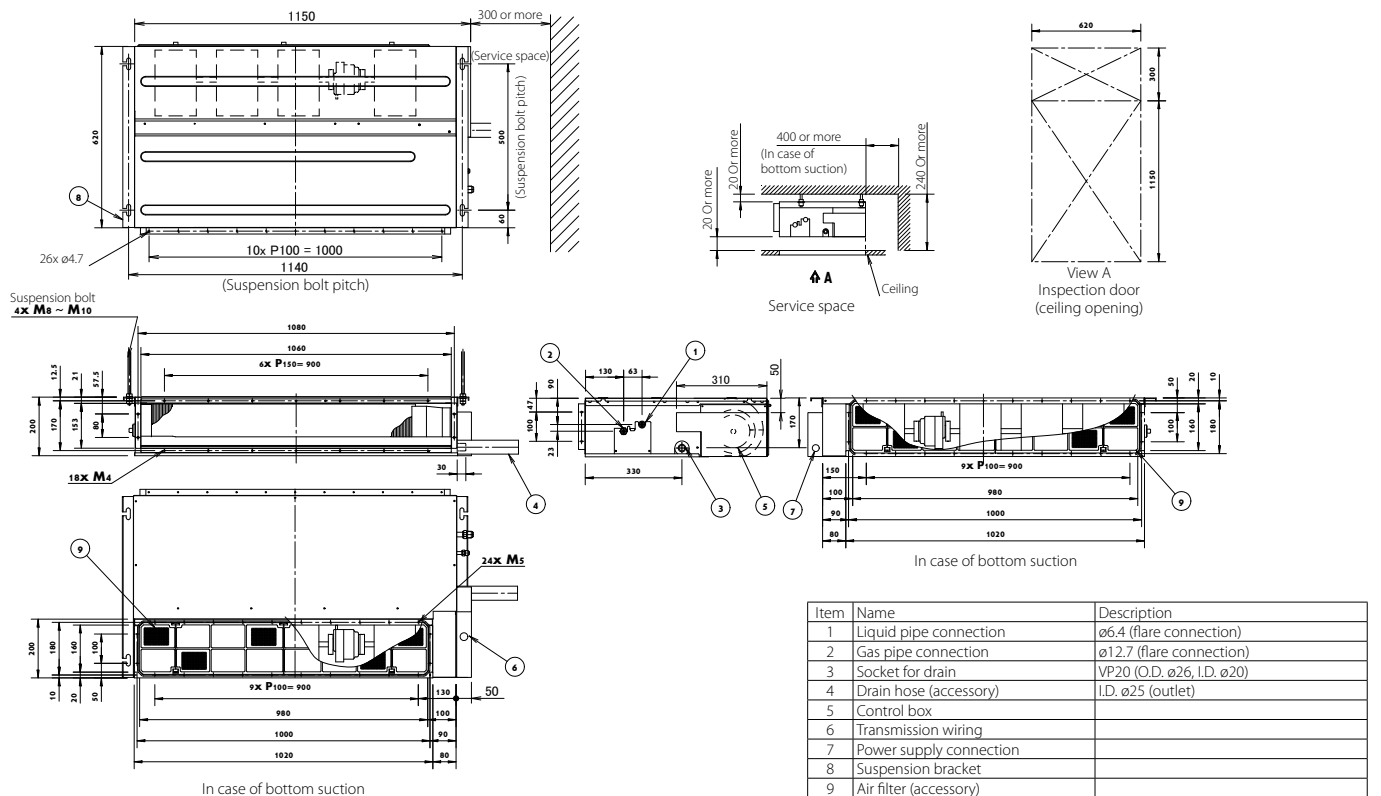

**3D081360**



**FDXM25-35F9**

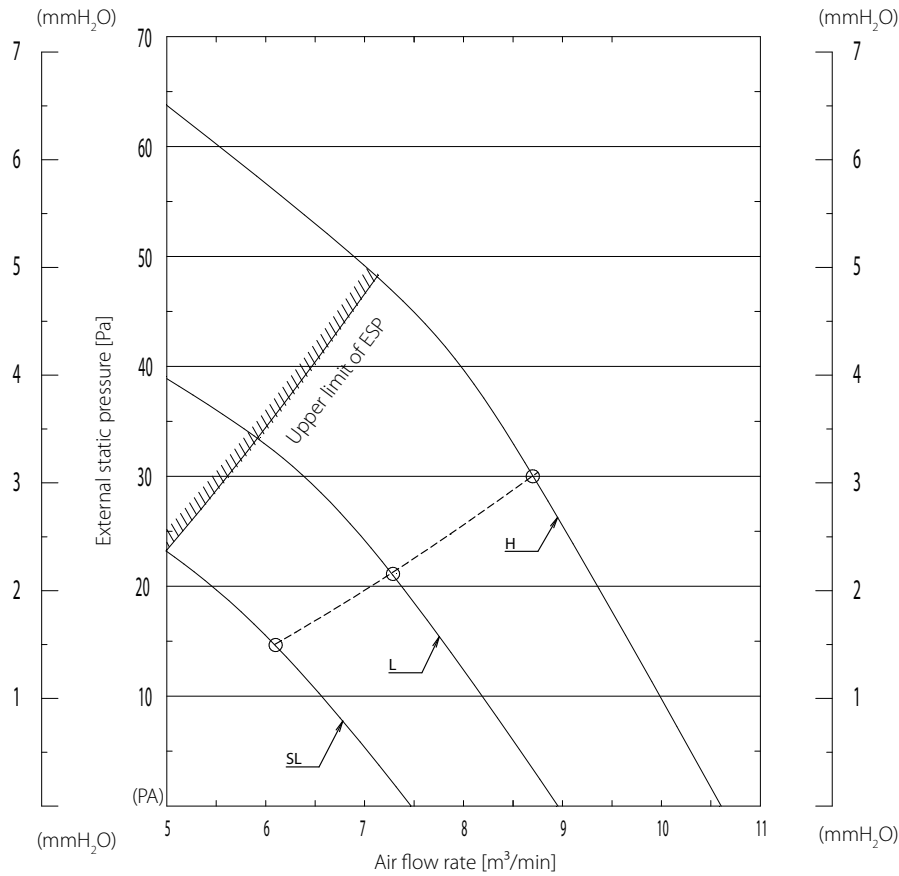

**3D081327C**

**FDXM50F9**

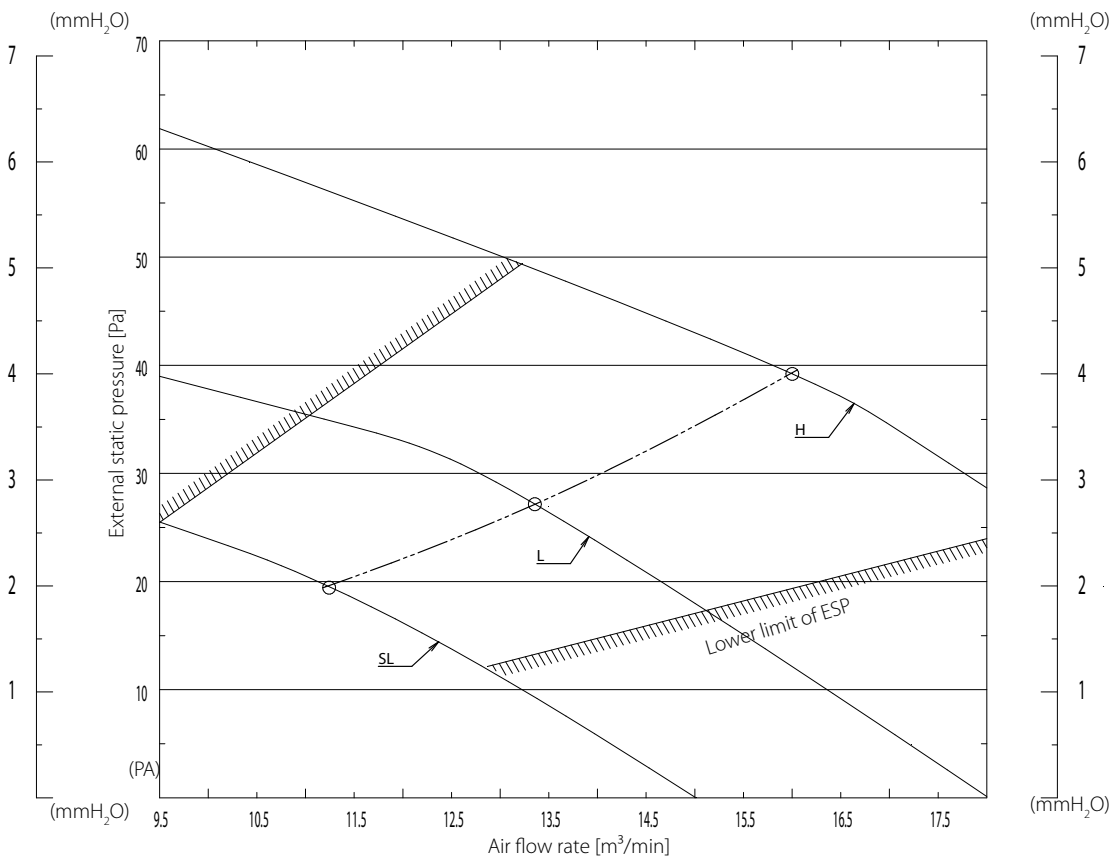

**3D085960C**



**FDXM60F9**

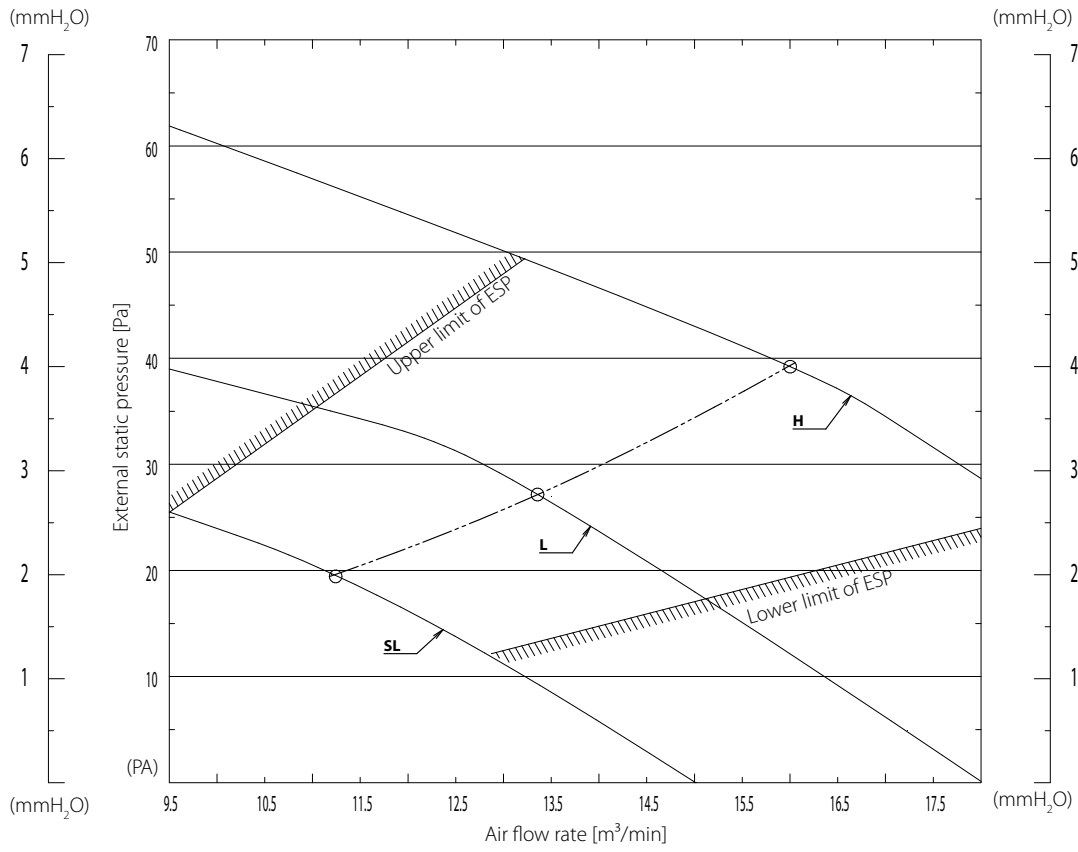

**3D081329C**



## Detailed technical drawings

### FBA35A9

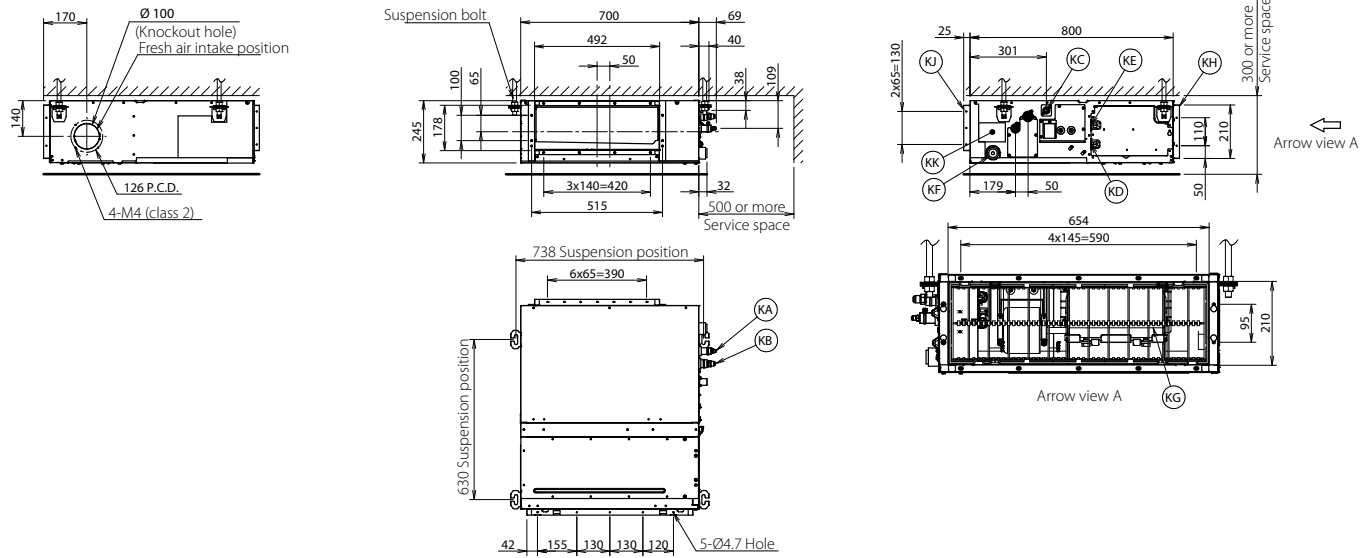

Item	Name	Description
KA	Liquid pipe connection port	ø6.35 flared connection
KB	Gas pipe connection port	ø9.52 flared connection
KC	Drain pipe connection	VP20 (OD ø26, ID ø20)
KD	Wiring connection	/
KE	Power supply connection	/
KF	Drain outlet	VP20 (OD ø26, ID ø20)
KG	Air filter	/
KH	Air suction side	/
KJ	Air discharge side	/
KK	Nameplate	/

#### NOTES

- When installing optional accessories, refer to their respective documentation.
- The ceiling depth varies according to the documentation of the specific system.

**3D094988B**

### FBA50A9

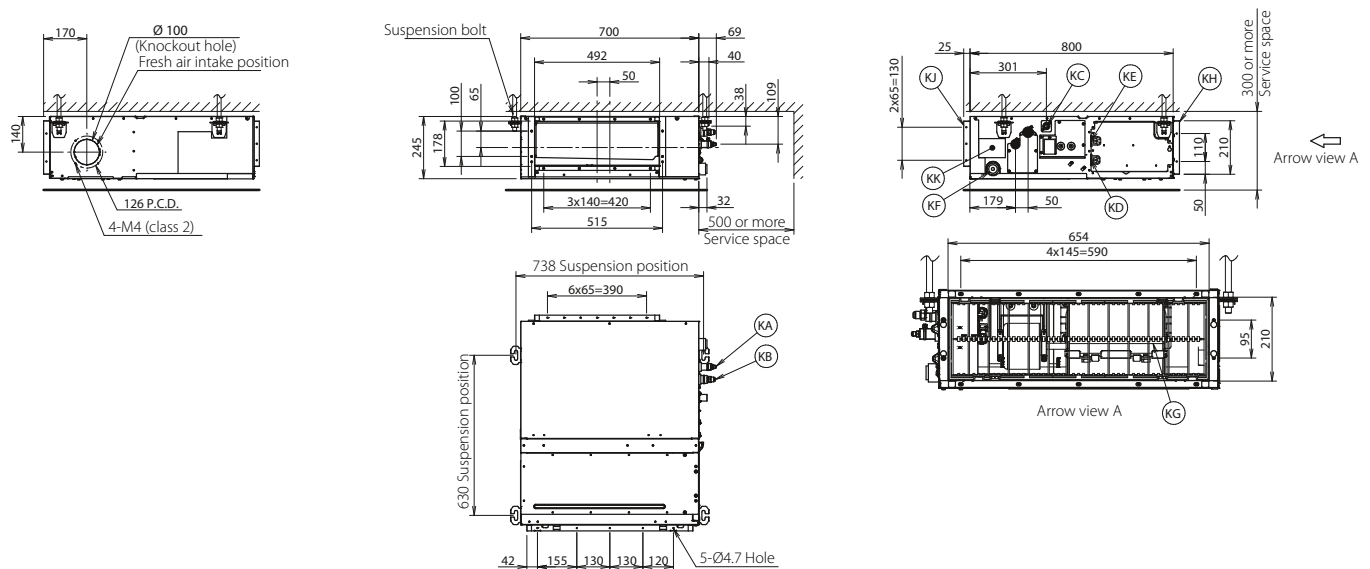

Item	Name	Description
KA	Liquid pipe connection port	ø6.35 flared connection
KB	Gas pipe connection port	ø12.70 flared connection
KC	Drain pipe connection	VP20 (OD ø26, ID ø20)
KD	Wiring connection	/
KE	Power supply connection	/
KF	Drain outlet	VP20 (OD ø26, ID ø20)
KG	Air filter	/
KH	Air suction side	/
KJ	Air discharge side	/
KK	Nameplate	/

#### NOTES

- When installing optional accessories, refer to their respective documentation.
- The ceiling depth varies according to the documentation of the specific system.

**3D094918B**



**FBA60A9**

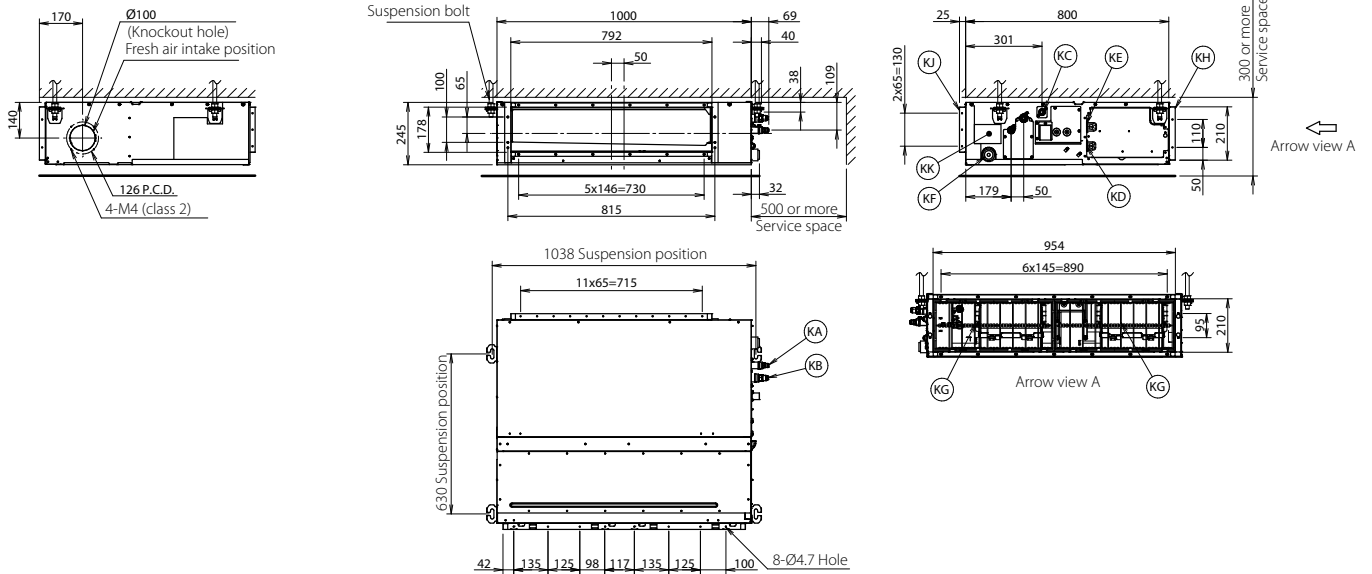

Item	Name	Description
KA	Liquid pipe connection port	ø6.35 flared connection
KB	Gas pipe connection port	ø12.70 flared connection
KC	Drain pipe connection	VP20 (OD ø26, ID ø20)
KD	Wiring connection	/
KE	Power supply connection	/
KF	Drain outlet	VP20 (OD ø26, ID ø20)
KG	Air filter	/
KH	Air suction side	/
KJ	Air discharge side	/
KK	Nameplate	/

**NOTES**

1. When installing optional accessories, refer to their respective documentation.
2. The ceiling depth varies according to the documentation of the specific system.

**3D094983B**

**FBA71A9**

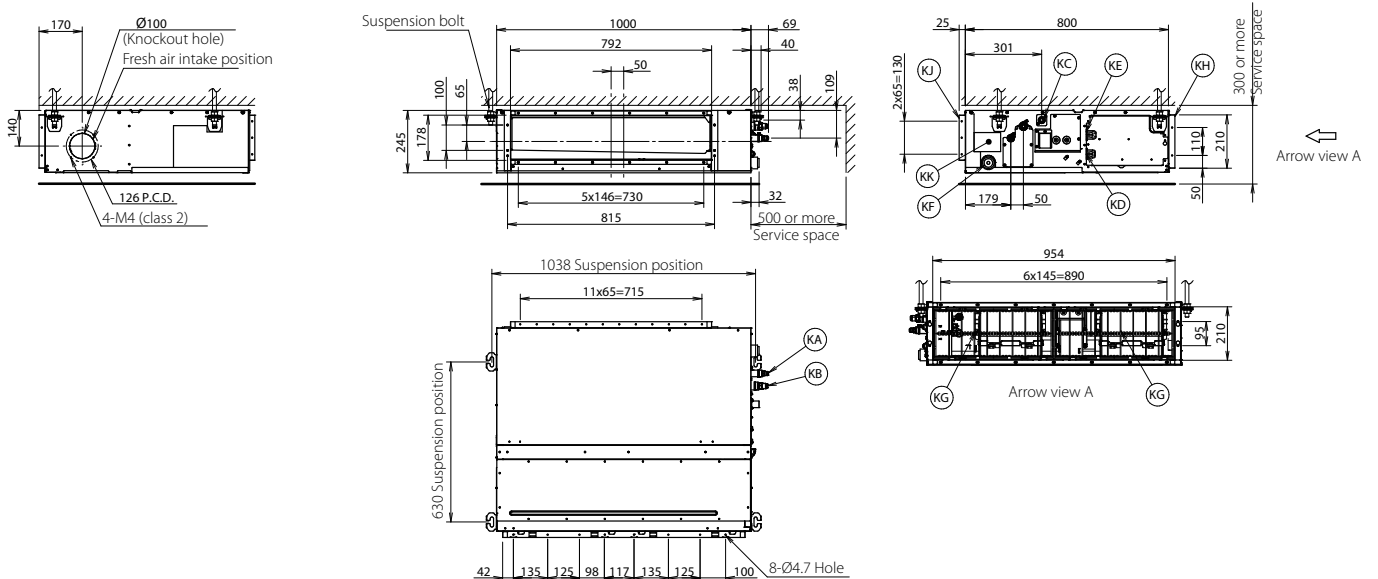

Item	Name	Description
KA	Liquid pipe connection port	ø9.52 flared connection
KB	Gas pipe connection port	ø15.90 flared connection
KC	Drain pipe connection	VP20 (OD ø26, ID ø20)
KD	Wiring connection	/
KE	Power supply connection	/
KF	Drain outlet	VP20 (OD ø26, ID ø20)
KG	Air filter	/
KH	Air suction side	/
KJ	Air discharge side	/
KK	Nameplate	/

**NOTES**

1. When installing optional accessories, refer to their respective documentation.
2. The ceiling depth varies according to the documentation of the specific system.

**3D094915B**

Detailed technical drawings

**FBA100-140A**

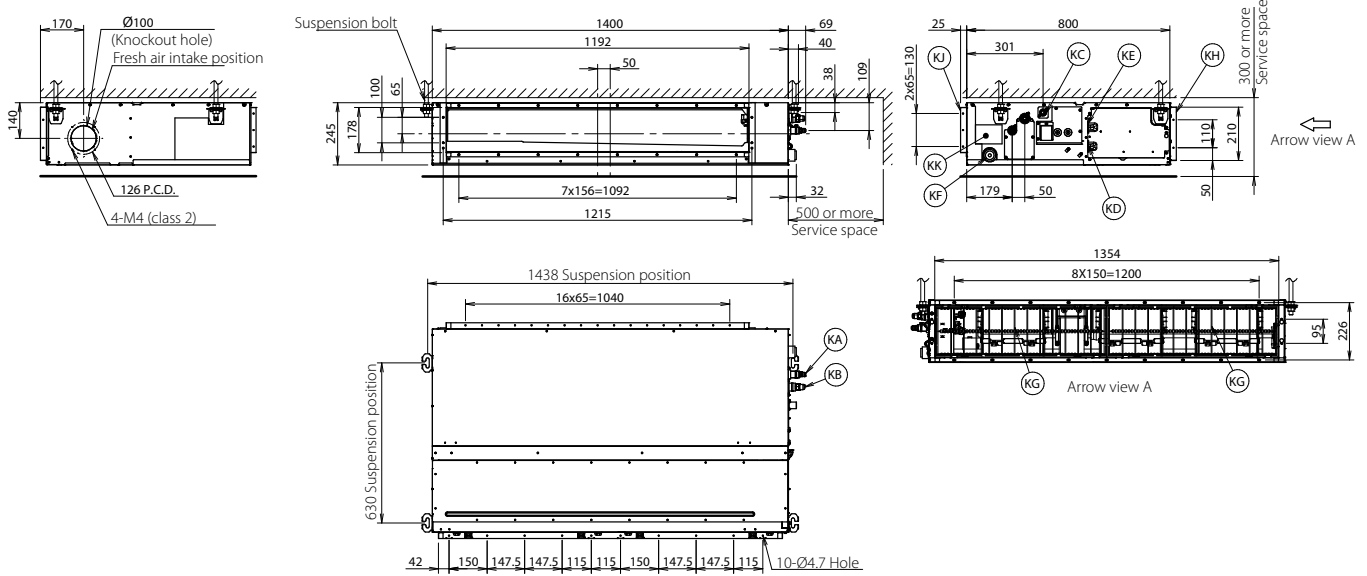

Item	Name	Description
KA	Liquid pipe connection port	ø9.52 flared connection
KB	Gas pipe connection port	ø15.90 flared connection
KC	Drain pipe connection	VP20 (OD ø26, ID ø20)
KD	Wiring connection	/
KE	Power supply connection	/
KF	Drain outlet	VP20 (OD ø26, ID ø20)
KG	Air filter	/
KH	Air suction side	/
KJ	Air discharge side	/
KK	Nameplate	/

**NOTES**

1. When installing optional accessories, refer to their respective documentation.
2. The ceiling depth varies according to the documentation of the specific system.

**3D094914B**

**FBA35-50A9**

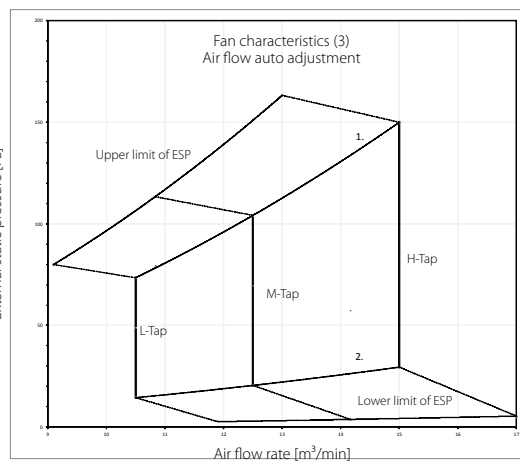
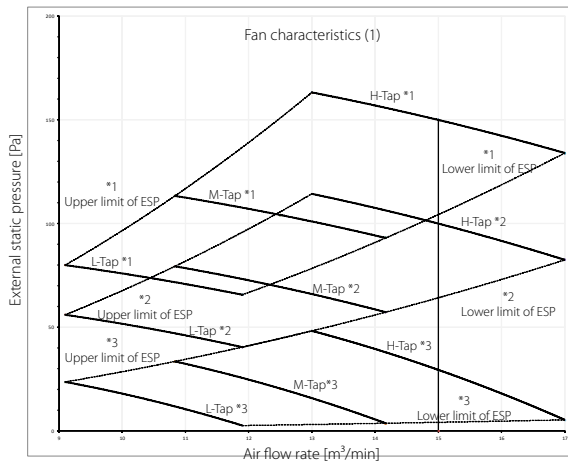

1. Upper limit of ESP by air flow auto adjustment
2. Lower limit of ESP by air flow auto adjustment

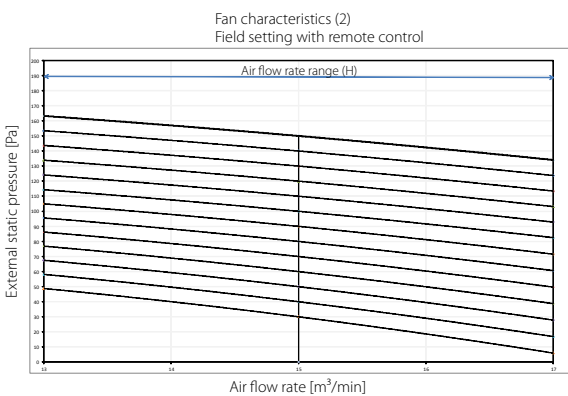

Mark		ESP [Pa]
*1	Maximum	150
*2	-	100
*3	Standard	30

**NOTES**

1. The fan characteristics shown are in "fan only" mode.
2. ESP: External Static Pressure

**3D095521B**



**FBA60-71A9**

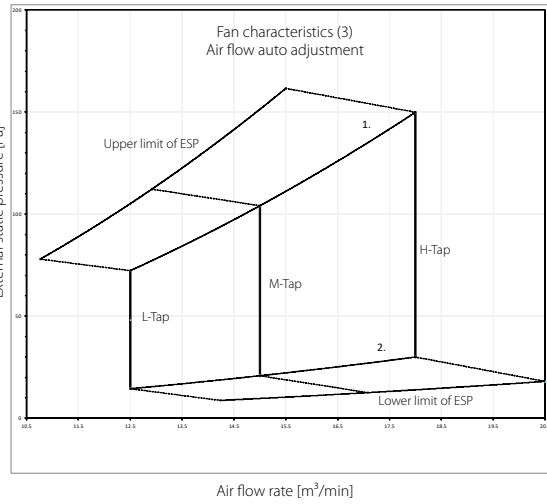
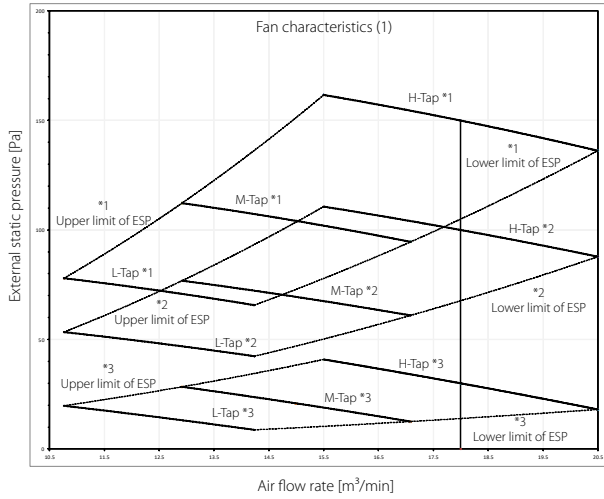

1. Upper limit of ESP by air flow auto adjustment
2. Lower limit of ESP by air flow auto adjustment

Fan characteristics (2)  
Field setting with remote control

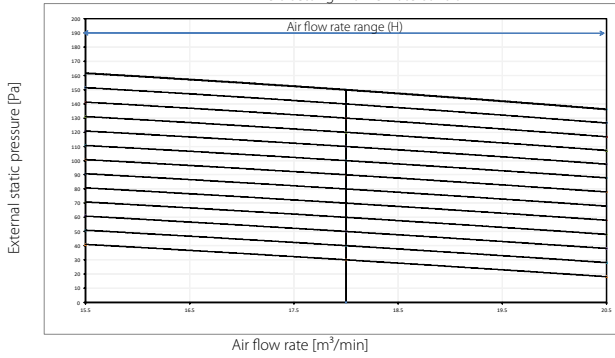

Mark		ESP [Pa]
*1	Maximum	150
*2	-	100
*3	Standard	30

**NOTES**

1. The fan characteristics shown are in "fan only" mode.
2. ESP: External Static Pressure

**3D095524B**

**FBA100A**

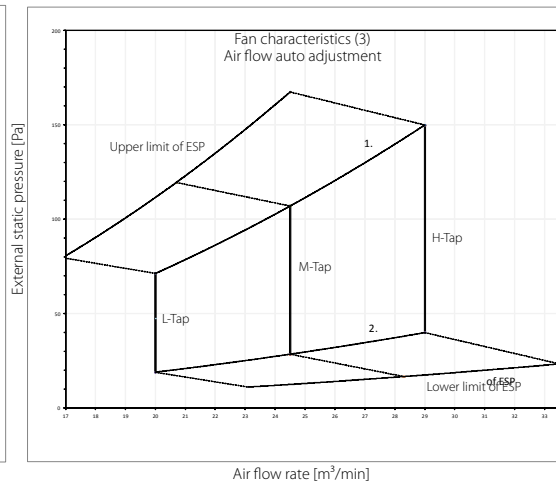
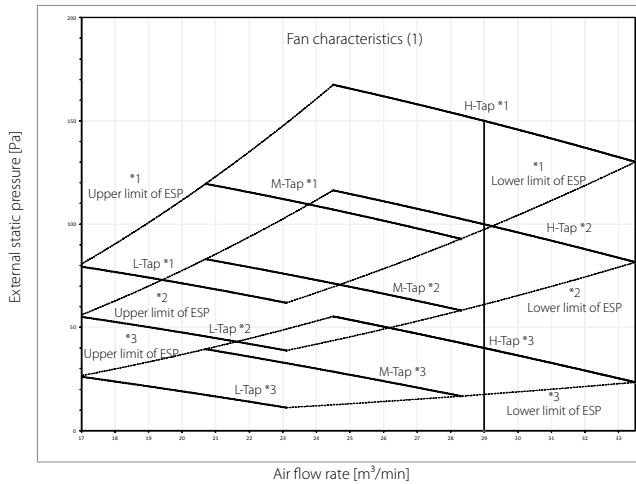

1. Upper limit of ESP by air flow auto adjustment
2. Lower limit of ESP by air flow auto adjustment

Fan characteristics (2)  
Field setting with remote control

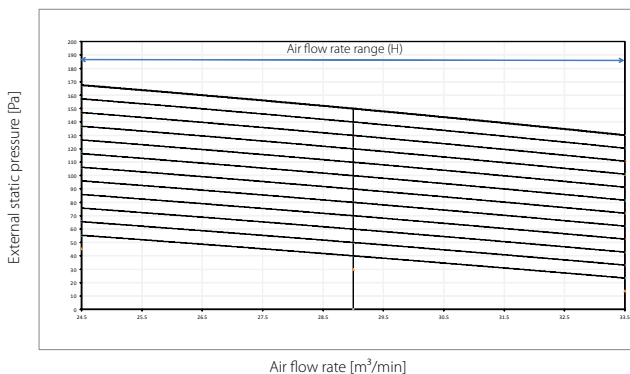

Mark		ESP [Pa]
*1	Maximum	150
*2	-	100
*3	Standard	30

**NOTES**

1. The fan characteristics shown are in "fan only" mode.
2. ESP: External Static Pressure

**3D095526B**

Detailed technical drawings

FBA125-140A

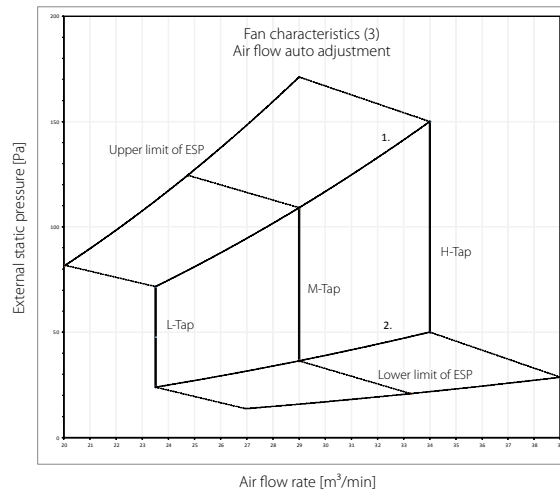
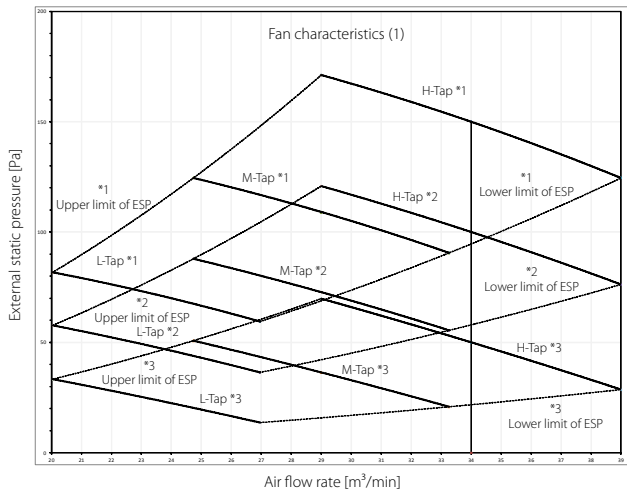

- 1. Upper limit of ESP by air flow auto adjustment
- 2. Lower limit of ESP by air flow auto adjustment

Fan characteristics (2)  
Field setting with remote control

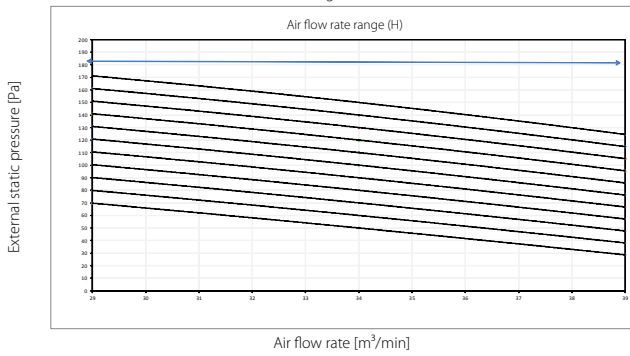

Mark		ESP [Pa]
*1	Maximum	150
*2	-	100
*3	Standard	30

NOTES

- 1. The fan characteristics shown are in "fan only" mode.
- 2. ESP: External Static Pressure

3D095527B



**FDA125A**

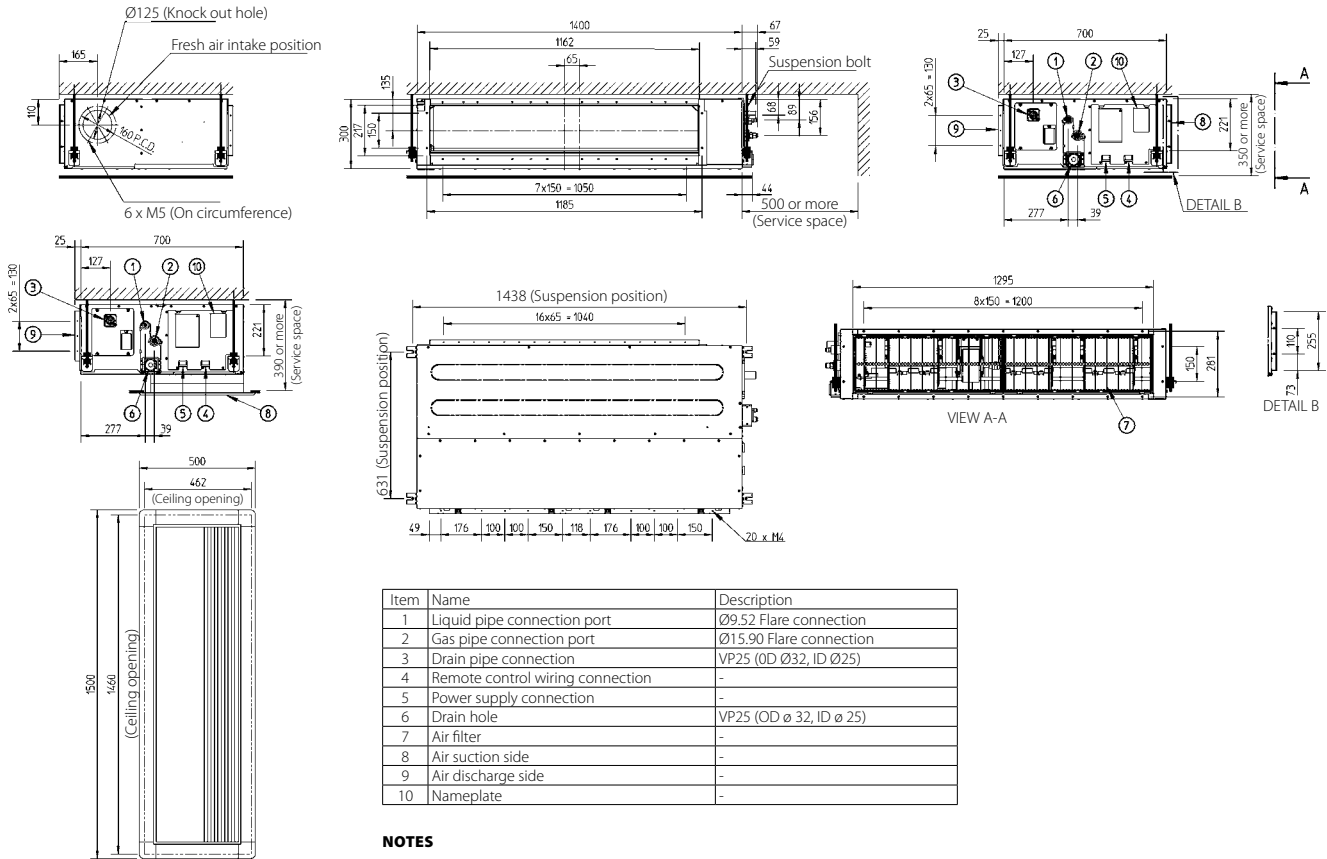

**NOTES**

1. Refer to the outlook drawing of optional accessories when installing them.
2. The required ceiling depth varies according to the configuration of the specific system.
3. For maintenance of the air filter, it is necessary to provide a service access panel.
4. Optional decoration panel: BYBS125DJW1 (light ivory white 10Y9/0.5)

**3TW31254-1B**

**FDA125A**

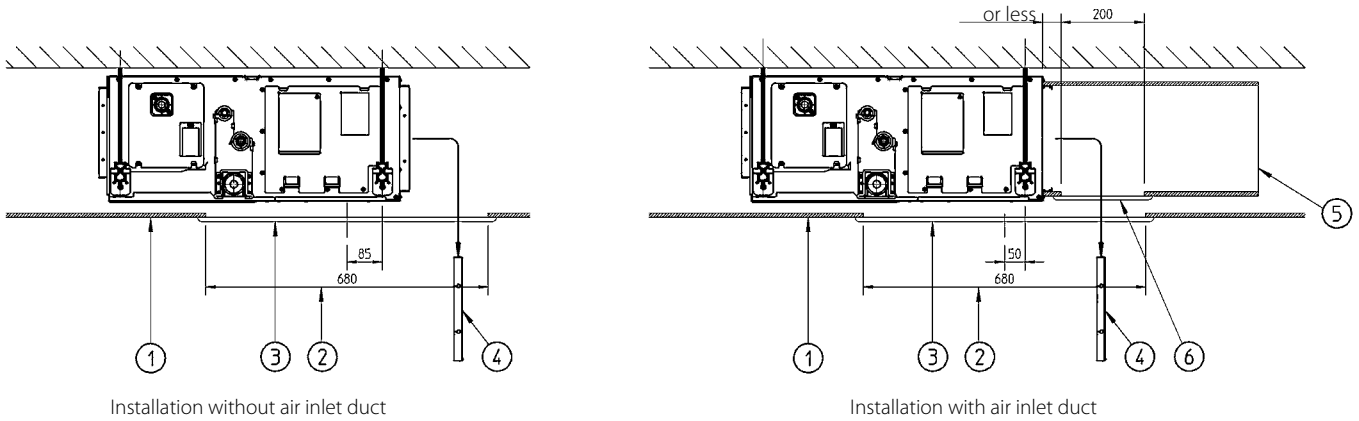

Installation without air inlet duct

Installation with air inlet duct

Number	Description
1	Suspended ceiling
2	Ceiling opening
3	Service access panel (optional)
4	Air filter
5	Air inlet duct
6	Duct service opening

**NOTES**

1. When installing the unit with rear suction, a service opening is necessary for the maintenance of the air filters.
2. When installing the unit with a suction duct, a service opening must be provided in the duct.

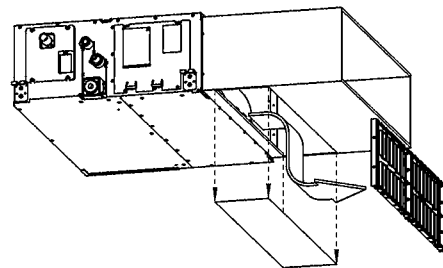

**3TW31184-4**

**FDA125A**

Fan characteristics (1)

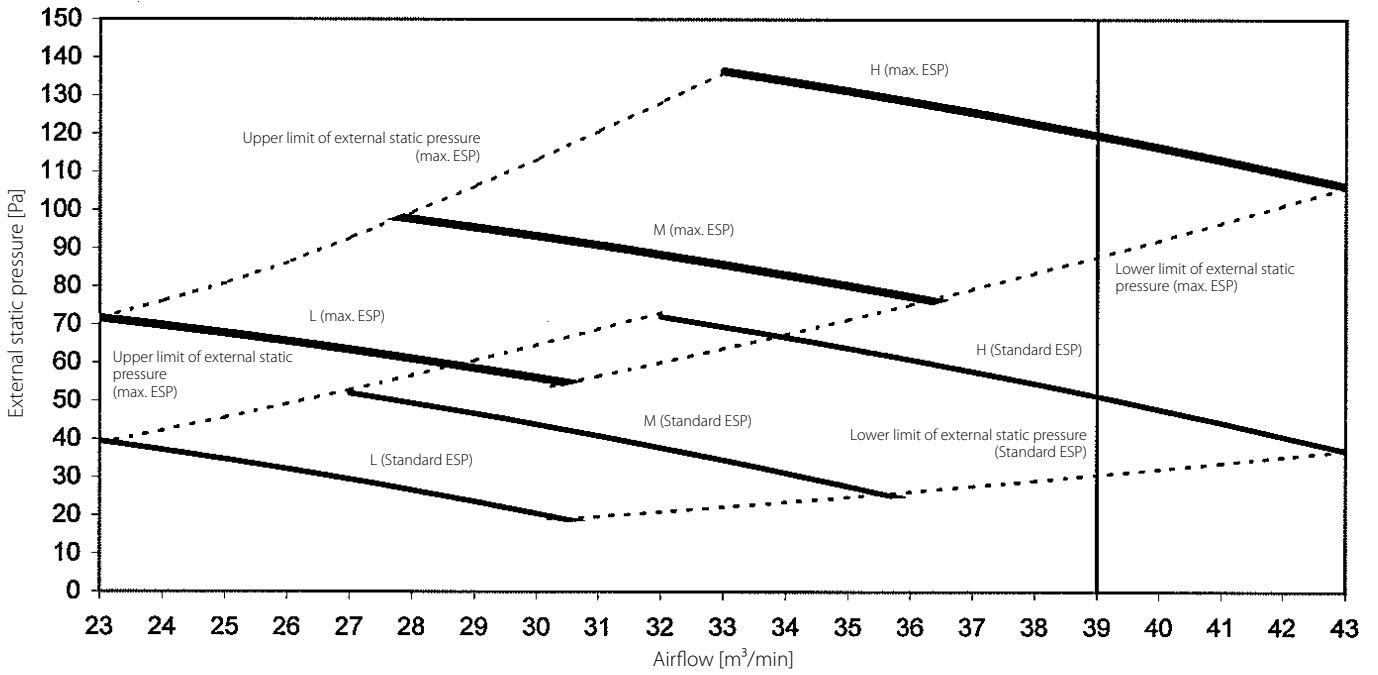

**NOTES**

- 1. The fan characteristics shown are in "fan only" mode.
- 2. ESP: External Static Pressure

**3TW31268-1**

**FDA125A**

Fan characteristics (2)  
 (Field setting with remote controller)  
 range of available air flow rate (H)

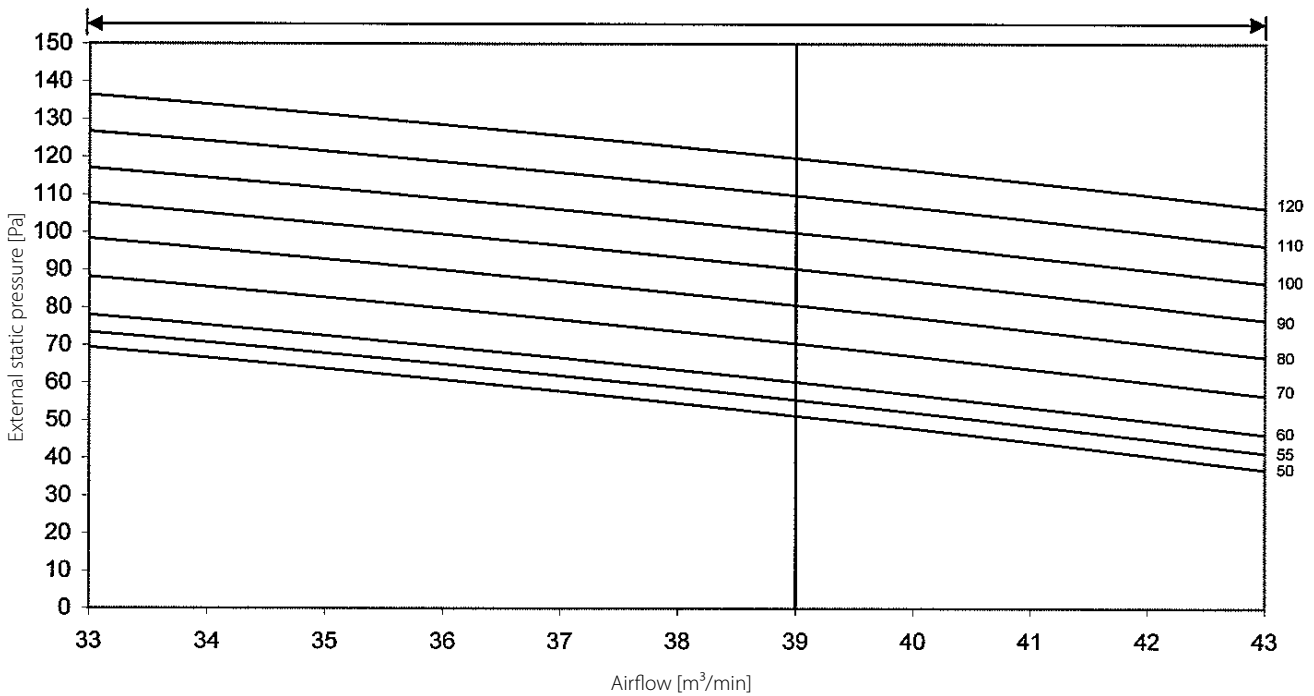

**NOTES**

- 1. The fan characteristics shown are in "fan only" mode.
- 2. ESP: External Static Pressure

**3TW31268-1**

FDA125A

Fan characteristics (3)  
(air flow auto adjustment)

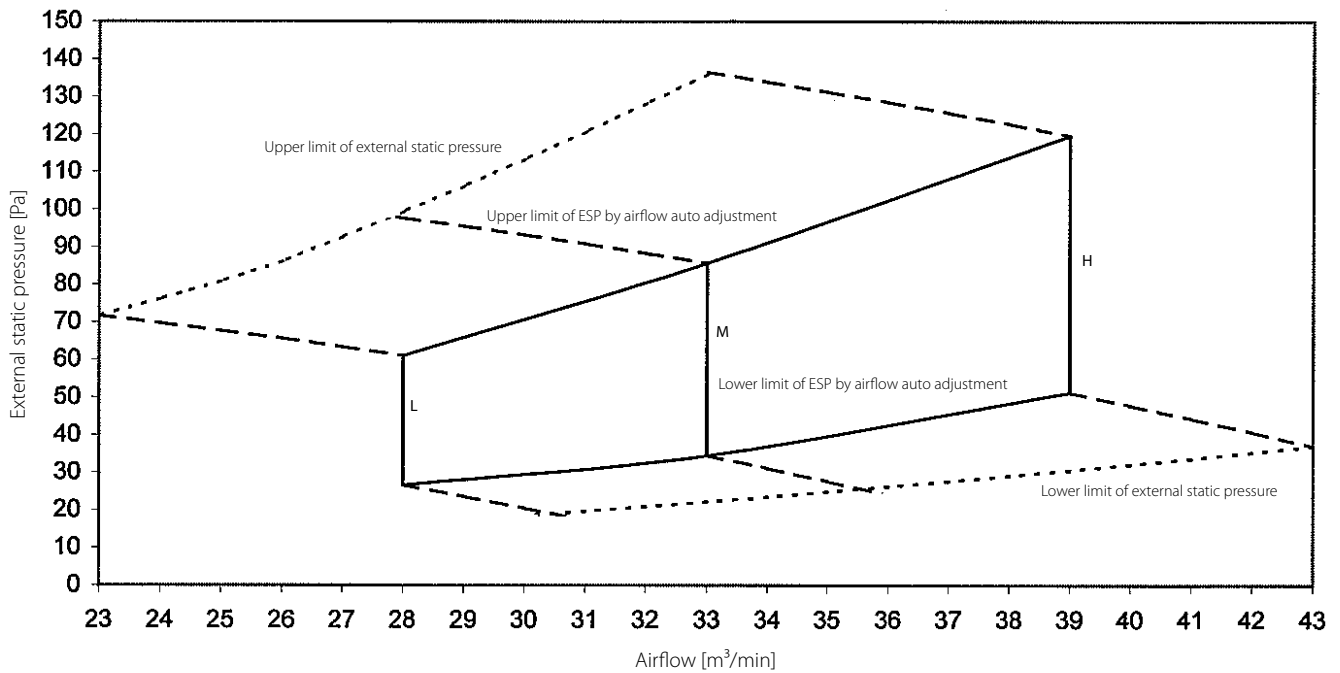

NOTES

1. The fan characteristics shown are in "fan only" mode.
2. ESP: External Static Pressure

3TW31268-1

FDA200-250A

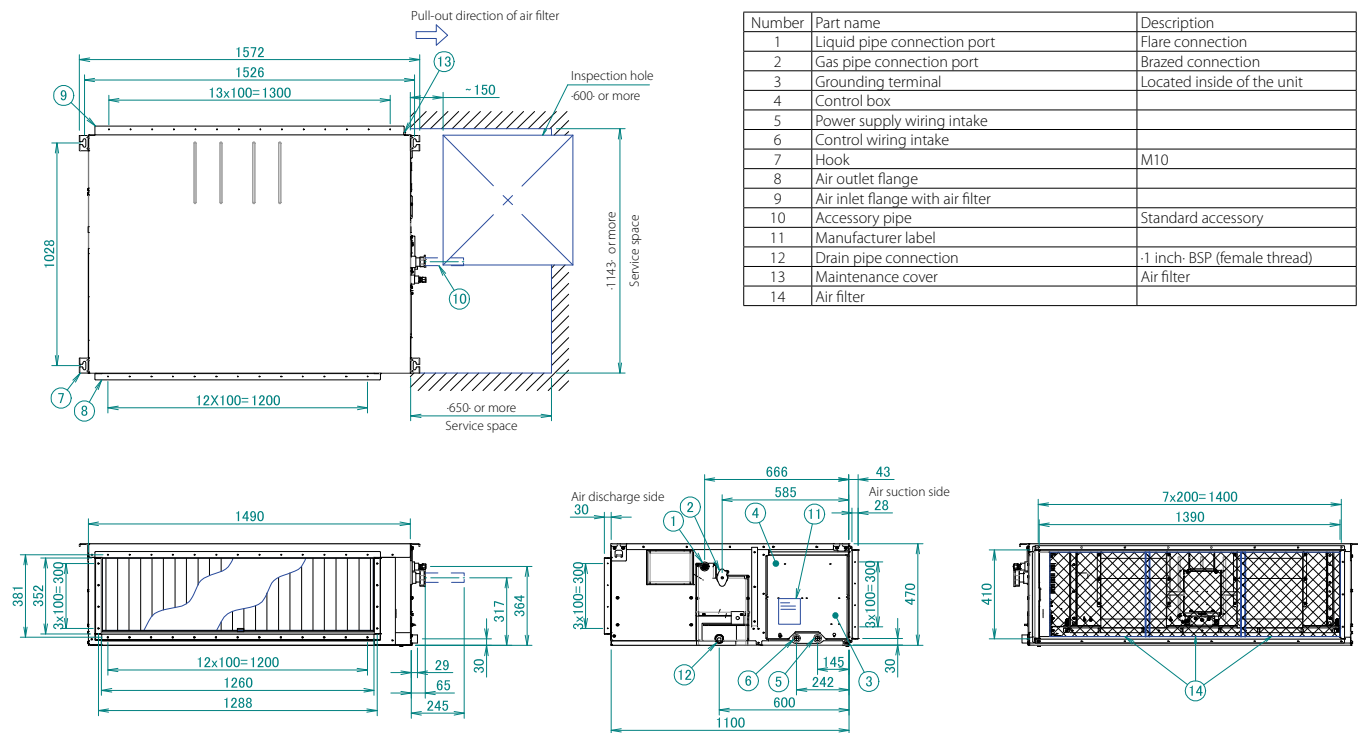

Piping connections Ø		
Indoor unit	Gas pipe	Liquid pipe
FDA200AXVEB	Ø 19.1 Accessory pipe	Ø 9.5
FDA250AXVEB	Ø 19.1 Accessory pipe	Ø 9.5

NOTES

1. The unit nameplate is located on the control box cover.

2D123907

**FDA200A**

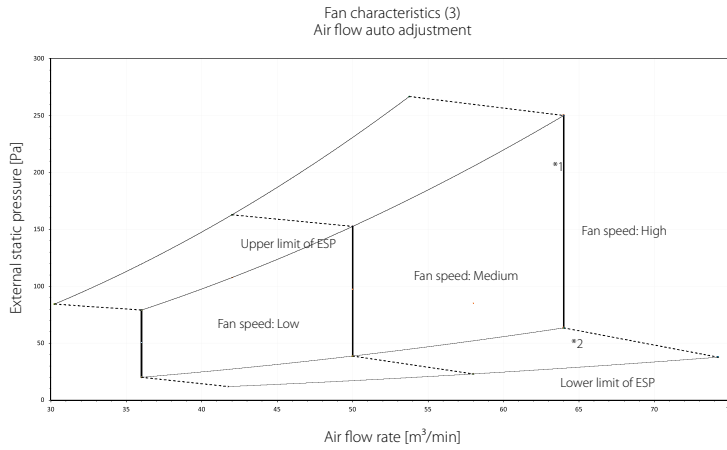
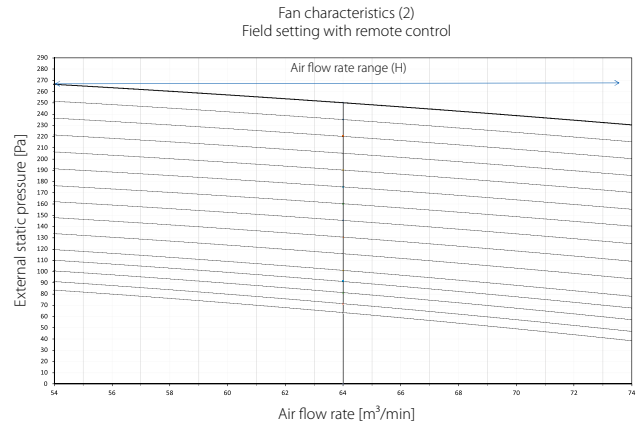
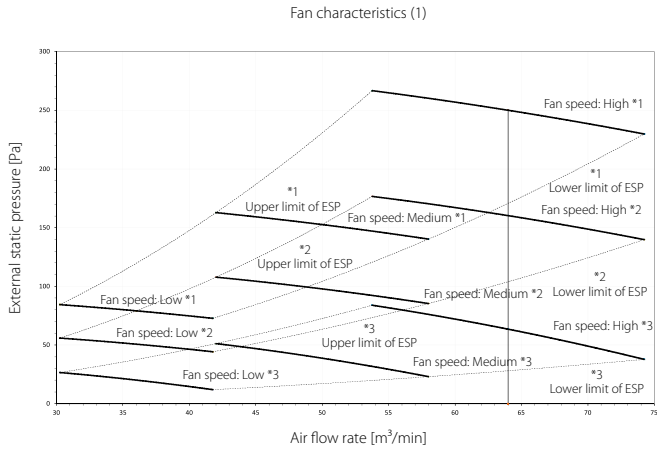

1. Upper limit of ESP by air flow auto adjustment
2. Lower limit of ESP by air flow auto adjustment

Mark		ESP [Pa]
*1	Maximum	160
*2	-	62
*3	Standard	

**4D124460**

**FDA250A**

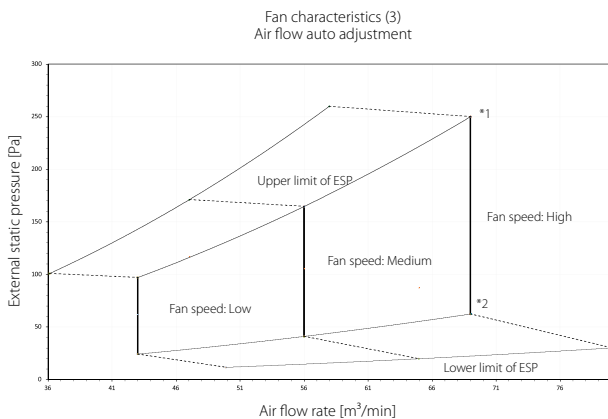
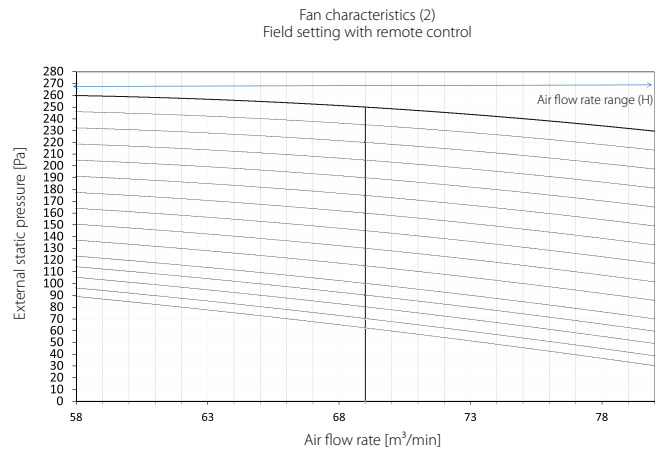
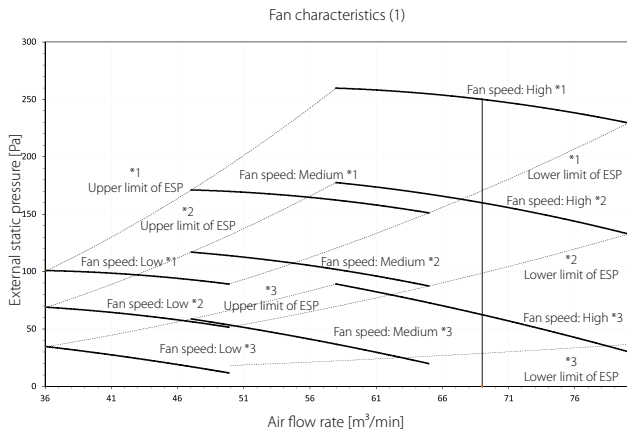

1. Upper limit of ESP by air flow auto adjustment
2. Lower limit of ESP by air flow auto adjustment

Mark		ESP [Pa]
*1	Maximum	250
*2	-	160
*3	Standard	62

**4D124478**





**ADEA35A9**

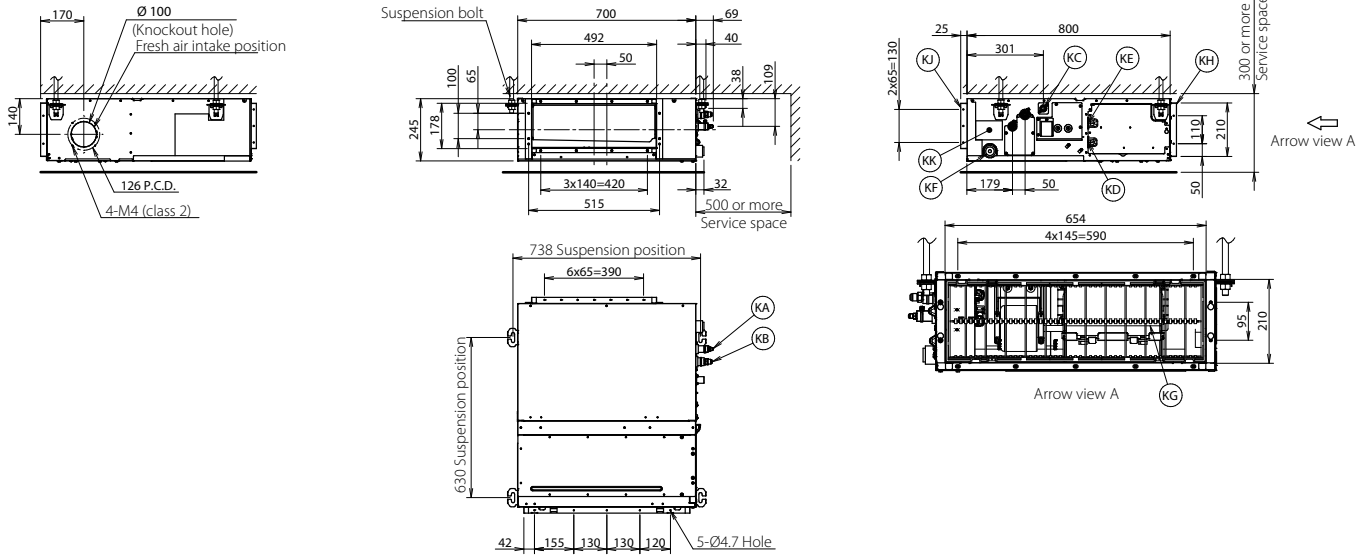

Item	Name	Description
KA	Liquid pipe connection port	ø6.35 flared connection
KB	Gas pipe connection port	ø9.52 flared connection
KC	Drain pipe connection	VP20 (OD ø26, ID ø20)
KD	Wiring connection	/
KE	Power supply connection	/
KF	Drain outlet	VP20 (OD ø26, ID ø20)
KG	Air filter	/
KH	Air suction side	/
KJ	Air discharge side	/
KK	Nameplate	/

**NOTES**

1. When installing optional accessories, refer to their respective documentation.
2. The ceiling depth varies according to the documentation of the specific system.

**3D094988B**

**ADEA50A9**

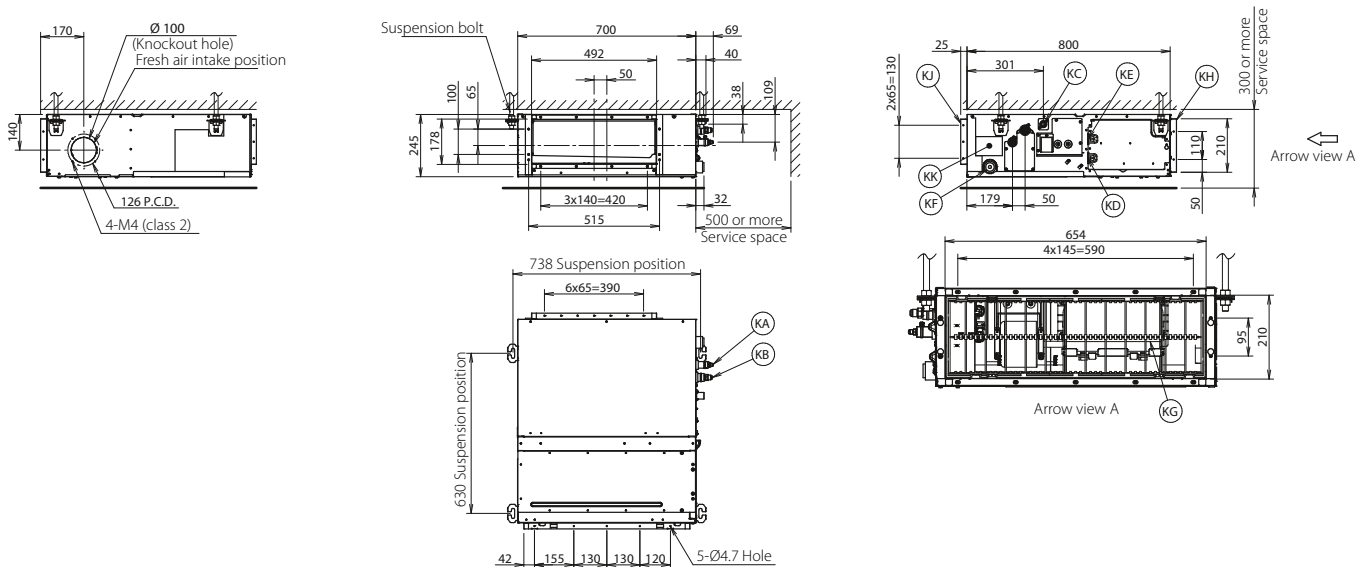

Item	Name	Description
KA	Liquid pipe connection port	ø6.35 flared connection
KB	Gas pipe connection port	ø12.70 flared connection
KC	Drain pipe connection	VP20 (OD ø26, ID ø20)
KD	Wiring connection	/
KE	Power supply connection	/
KF	Drain outlet	VP20 (OD ø26, ID ø20)
KG	Air filter	/
KH	Air suction side	/
KJ	Air discharge side	/
KK	Nameplate	/

**NOTES**

1. When installing optional accessories, refer to their respective documentation.
2. The ceiling depth varies according to the documentation of the specific system.

**3D094918B**

Detailed technical drawings

ADEA60A9

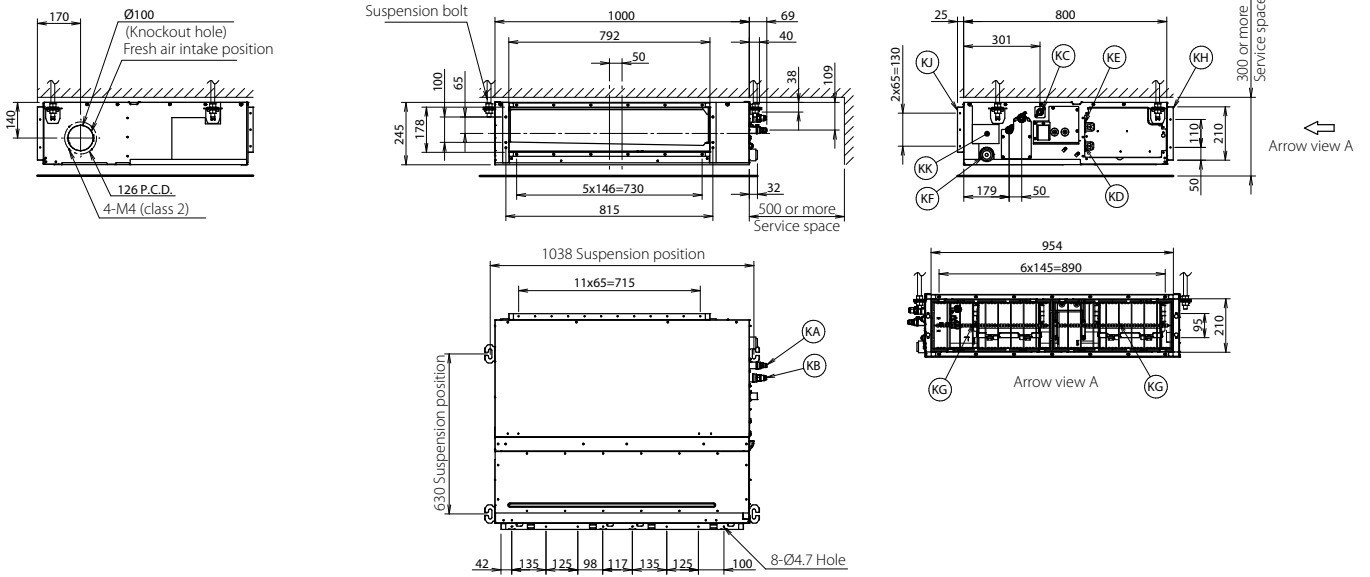

Item	Name	Description
KA	Liquid pipe connection port	ø6.35 flared connection
KB	Gas pipe connection port	ø12.70 flared connection
KC	Drain pipe connection	VP20 (OD ø26, ID ø20)
KD	Wiring connection	/
KE	Power supply connection	/
KF	Drain outlet	VP20 (OD ø26, ID ø20)
KG	Air filter	/
KH	Air suction side	/
KJ	Air discharge side	/
KK	Nameplate	/

NOTES

1. When installing optional accessories, refer to their respective documentation.
2. The ceiling depth varies according to the documentation of the specific system.

3D094983B

ADEA71A9

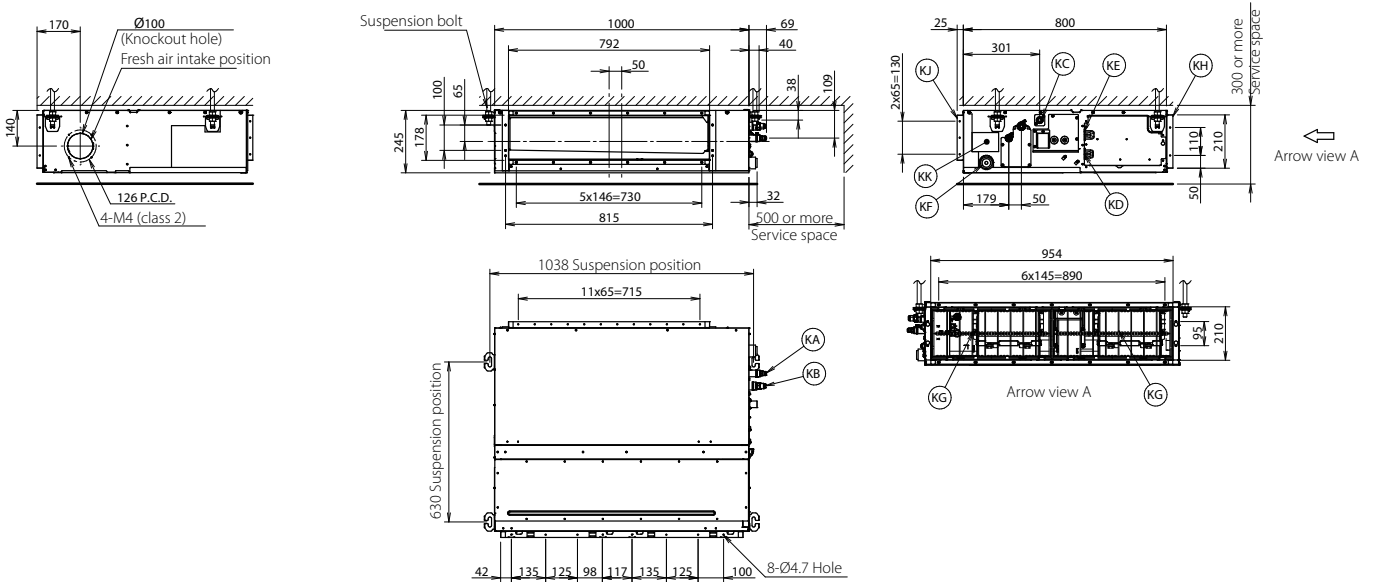

Item	Name	Description
KA	Liquid pipe connection port	ø9.52 flared connection
KB	Gas pipe connection port	ø15.90 flared connection
KC	Drain pipe connection	VP20 (OD ø26, ID ø20)
KD	Wiring connection	/
KE	Power supply connection	/
KF	Drain outlet	VP20 (OD ø26, ID ø20)
KG	Air filter	/
KH	Air suction side	/
KJ	Air discharge side	/
KK	Nameplate	/

NOTES

1. When installing optional accessories, refer to their respective documentation.
2. The ceiling depth varies according to the documentation of the specific system.

3D094915B

**ADEA100-125A**

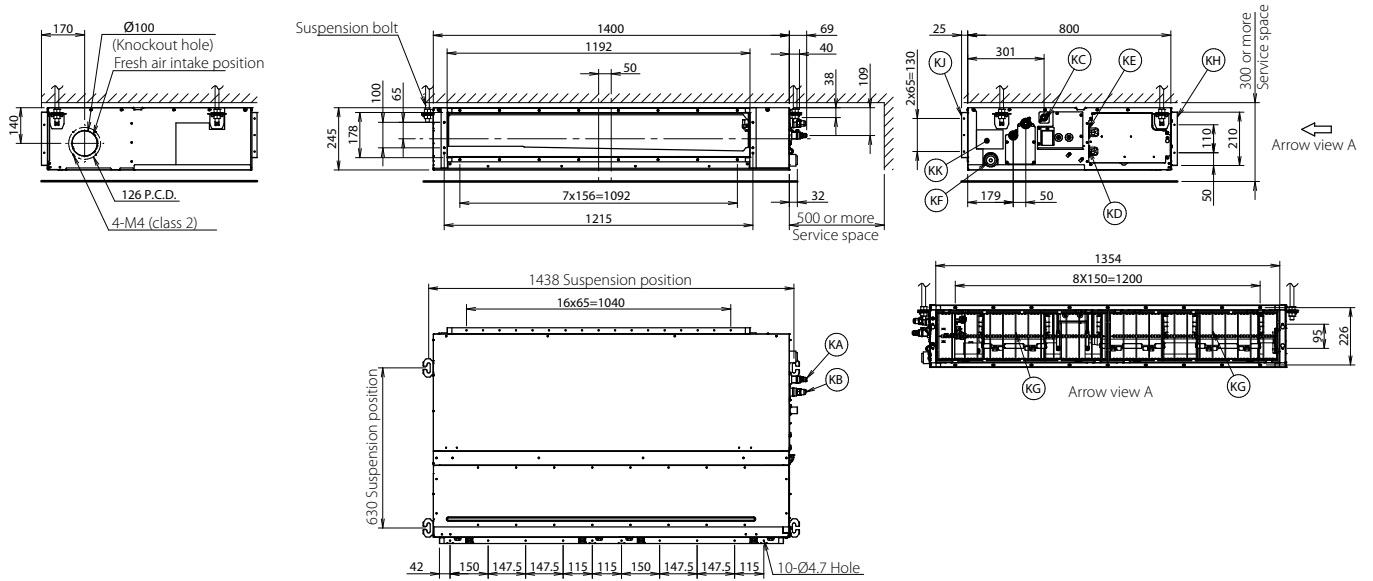

Item	Name	Description
KA	Liquid pipe connection port	ø9.52 flared connection
KB	Gas pipe connection port	ø15.90 flared connection
KC	Drain pipe connection	VP20 (OD ø26, ID ø20)
KD	Wiring connection	/
KE	Power supply connection	/
KF	Drain outlet	VP20 (OD ø26, ID ø20)
KG	Air filter	/
KH	Air suction side	/
KJ	Air discharge side	/
KK	Nameplate	/

**NOTES**

1. When installing optional accessories, refer to their respective documentation.
2. The ceiling depth varies according to the documentation of the specific system.

**3D094914B**

**ADEA35-50A9**

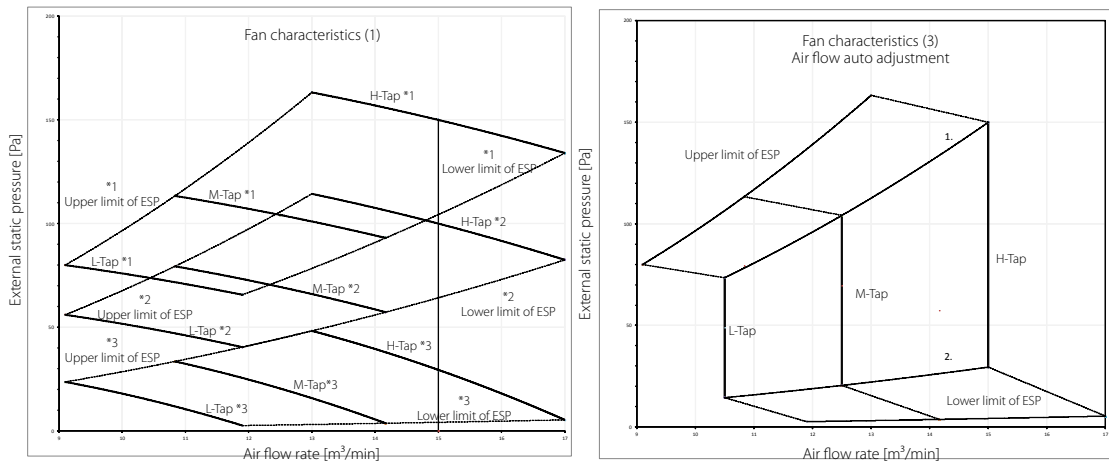

1. Upper limit of ESP by air flow auto adjustment
2. Lower limit of ESP by air flow auto adjustment

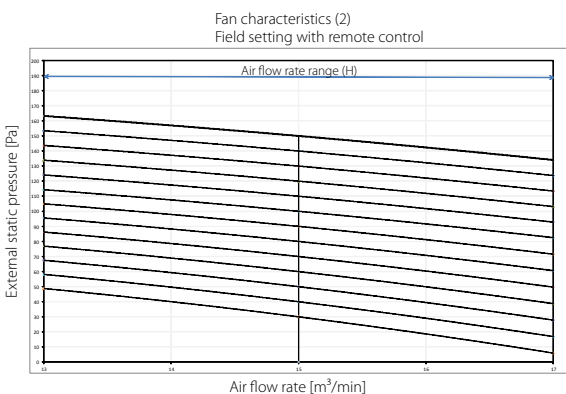

Mark		ESP [Pa]
*1	Maximum	150
*2	-	100
*3	Standard	30

**NOTES**

1. The fan characteristics shown are in "fan only" mode.
2. ESP: External Static Pressure

**3D095521B**

## Detailed technical drawings

### ADEA60-71A9

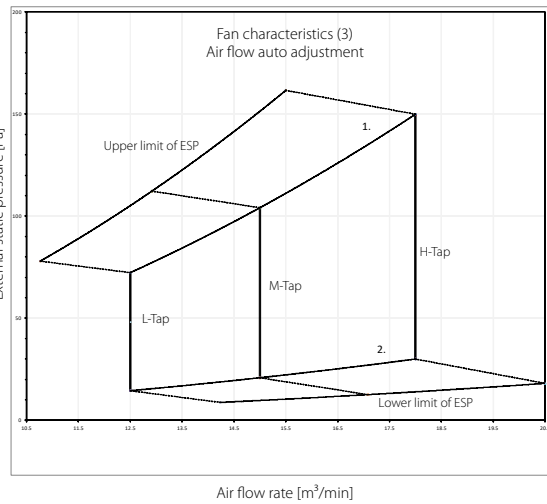
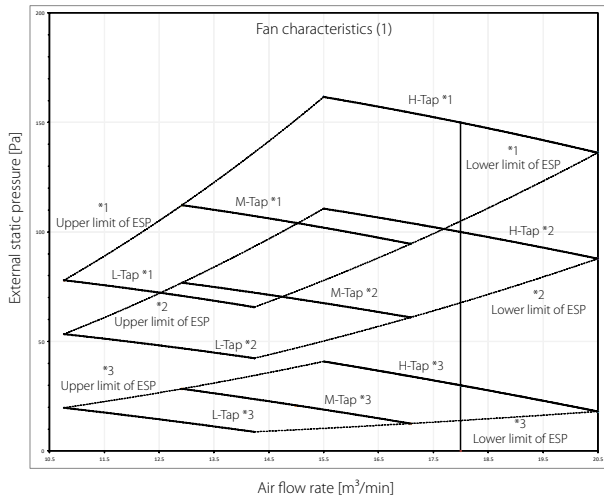

1. Upper limit of ESP by air flow auto adjustment
2. Lower limit of ESP by air flow auto adjustment

Fan characteristics (2)  
Field setting with remote control

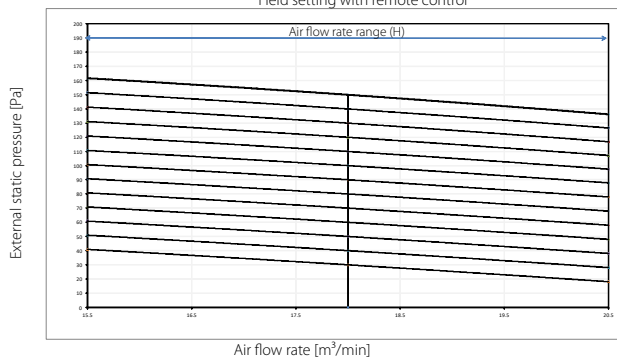

Mark		ESP [Pa]
*1	Maximum	150
*2	-	100
*3	Standard	30

#### NOTES

1. The fan characteristics shown are in "fan only" mode.
2. ESP: External Static Pressure

**3D095524B**

### ADEA100A

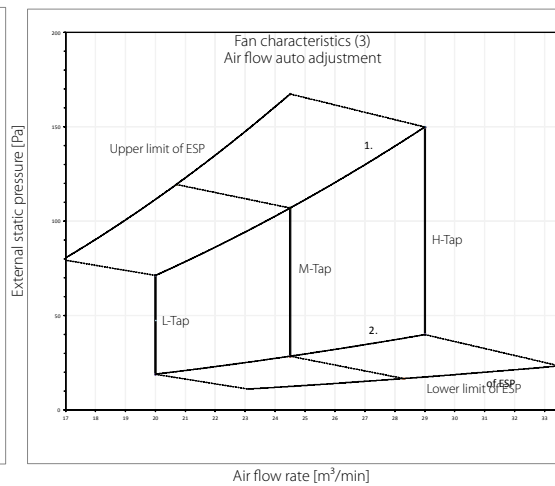
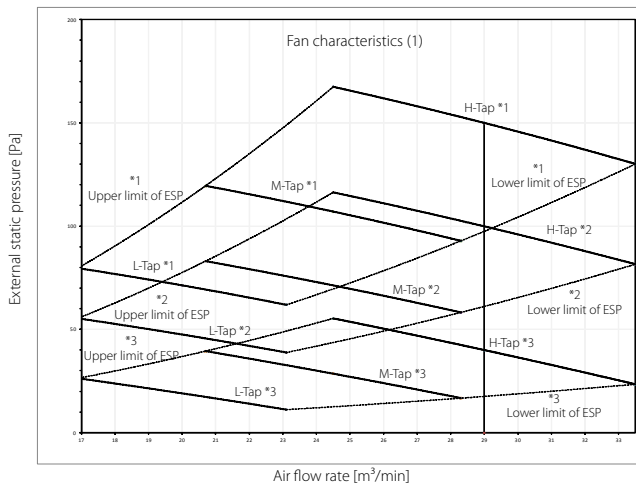

1. Upper limit of ESP by air flow auto adjustment
2. Lower limit of ESP by air flow auto adjustment

Fan characteristics (2)  
Field setting with remote control

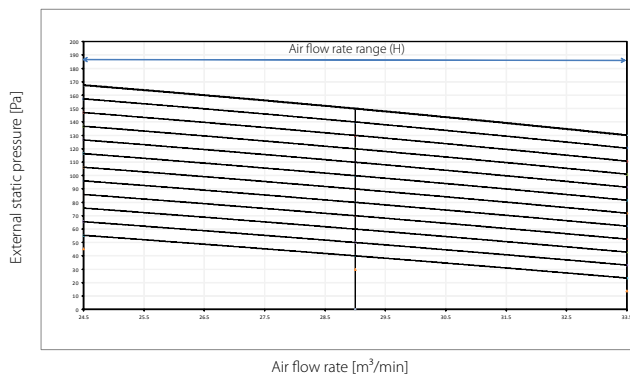

Mark		ESP [Pa]
*1	Maximum	150
*2	-	100
*3	Standard	30

#### NOTES

1. The fan characteristics shown are in "fan only" mode.
2. ESP: External Static Pressure

**3D095526B**



**ADEA125A**

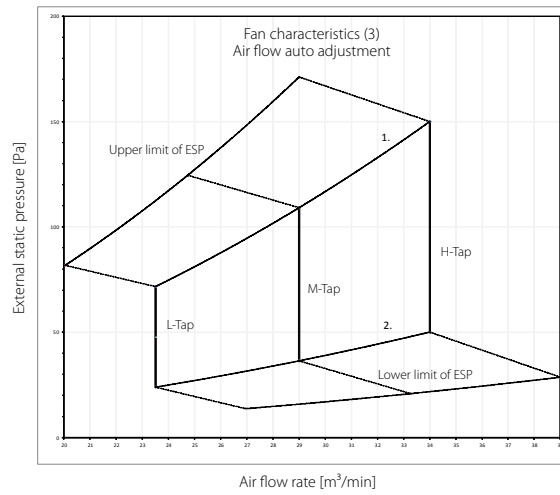
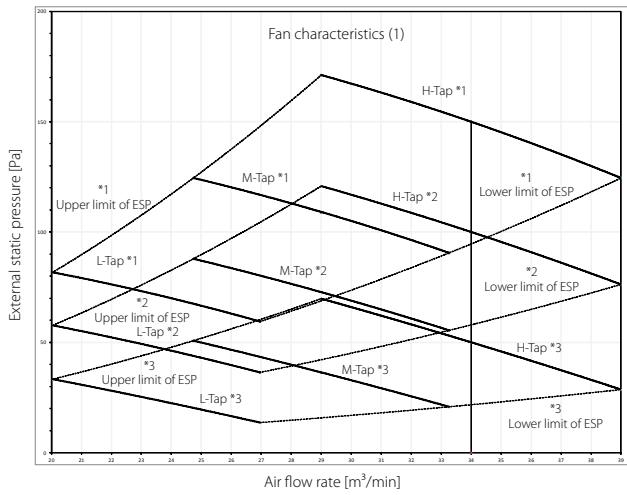

1. Upper limit of ESP by air flow auto adjustment
2. Lower limit of ESP by air flow auto adjustment

Fan characteristics (2)  
Field setting with remote control

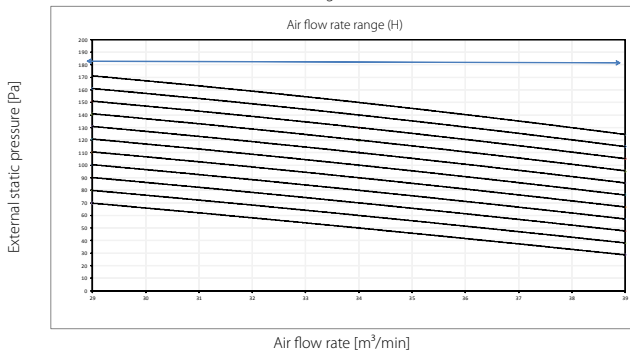

Mark		ESP [Pa]
*1	Maximum	150
*2	-	100
*3	Standard	30

**NOTES**

1. The fan characteristics shown are in "fan only" mode.
2. ESP: External Static Pressure

**3D095527B**

Detailed technical drawings

FAA71B

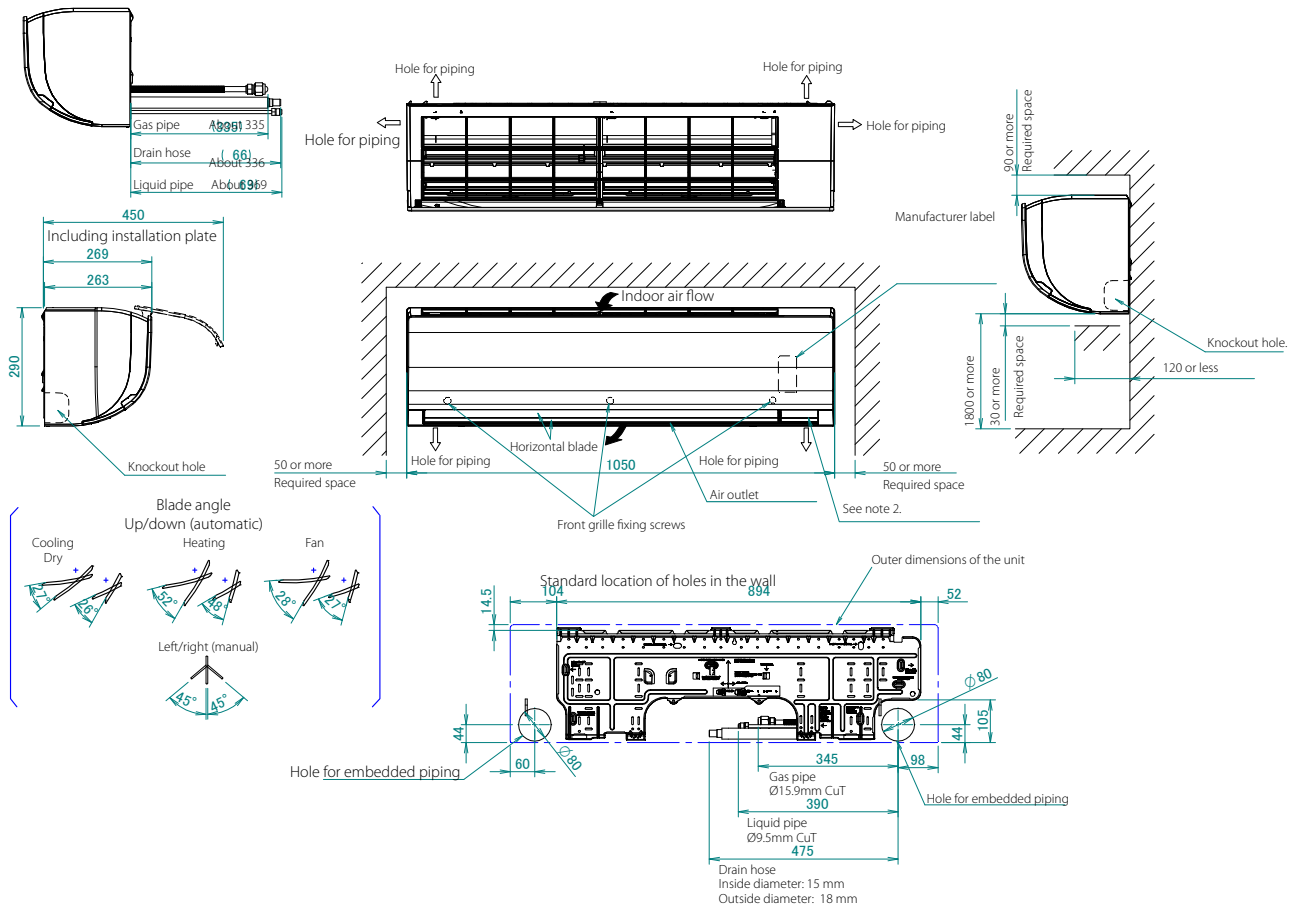

NOTES

1. The mark (➔) shows piping direction
2. When installing a wireless controller, there will be a receiver on this location. For details, see the drawing of the wireless controller.
3. Do not place any objects under the indoor unit. In case of high humidity (>80%), clogged drain outlets, or dirty air filters, condensate may drop out.

3D134459

FAA100B

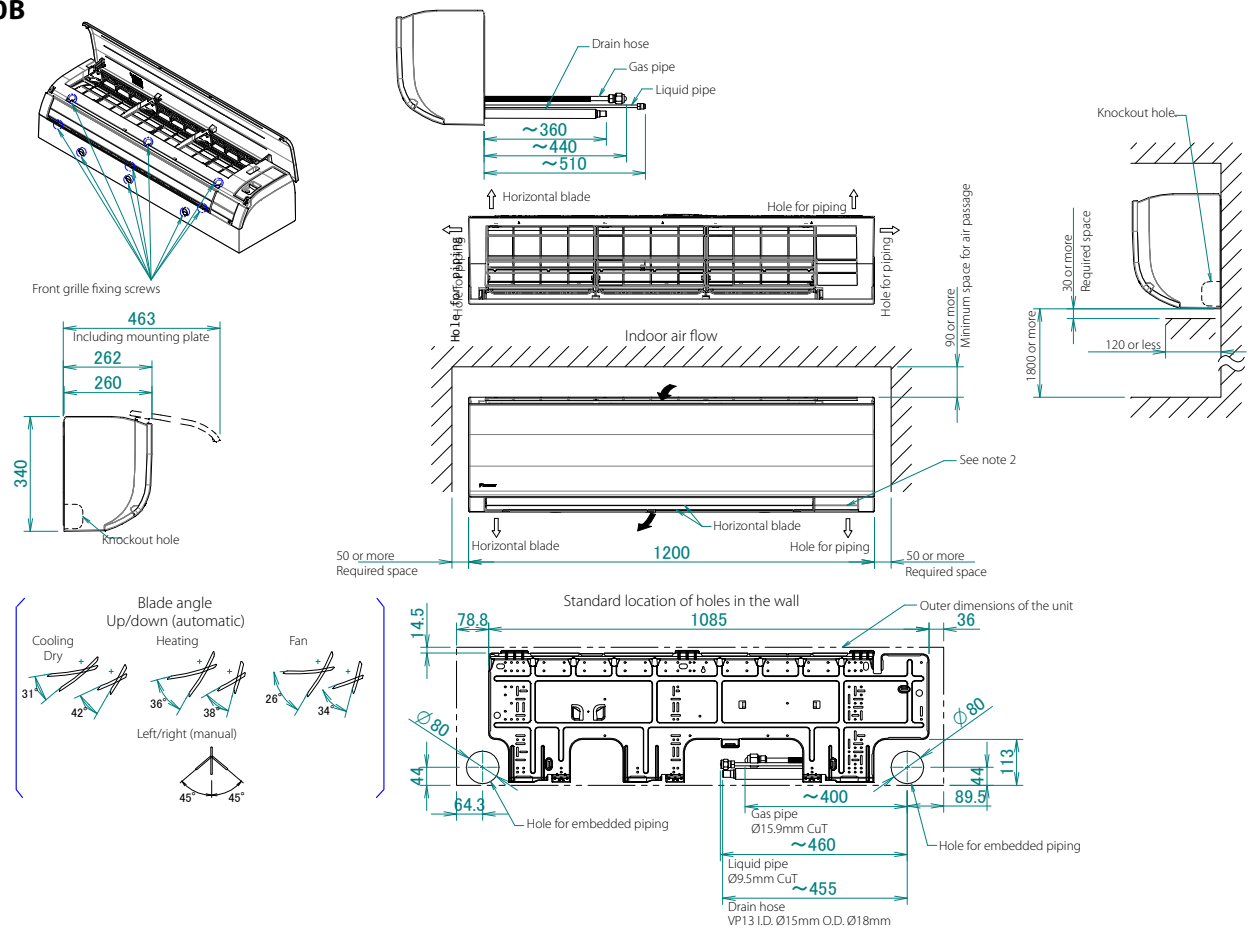

NOTES

1. The mark (➔) shows piping direction
2. When installing a wireless controller, there will be a receiver on this location. For details, see the drawing of the wireless controller.
3. Do not place any objects under the indoor unit. In case of high humidity (>80%), clogged drain outlets, or dirty air filters, condensate may drop out.

3D135741

**FHA35A9**

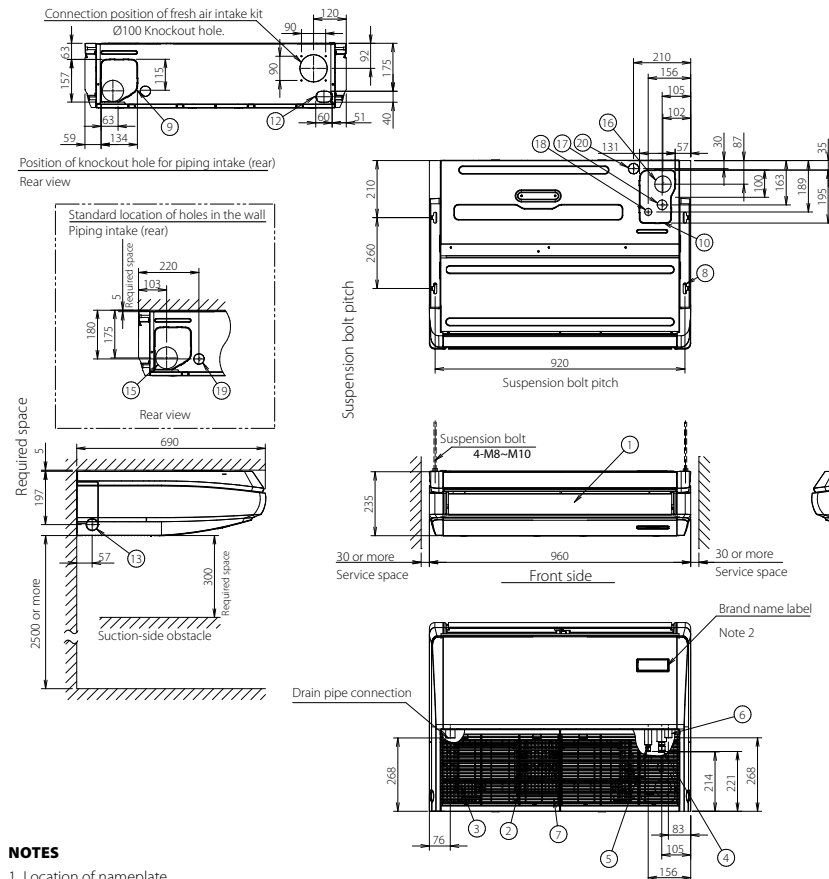

Number	Name	Description
1	Air discharge grille	
2	Air suction grille	
3	Air filter	
4	Gas pipe connection Ø9.5 flare	
5	Liquid pipe connection Ø6.4 flare	
6	Drain pipe connection	VP20
7	Terminal block with earth terminal Located inside of the unit	M4
8	Metal hanger	
9	Position of knockout hole	Rear side
10	Position of knockout hole	Top
11	Piping intake (right)	Knockout hole
12	Drain piping intake (left-rear)	Knockout hole
13	Drain piping intake (left)	Knockout hole
14	Drain piping intake (right)	Knockout hole
15	Standard location of holes in the wall Piping intake (rear)	Ø100
16	Drain piping intake (top)	Ø60
17	Gas piping intake (top)	Ø36
18	Liquid piping intake (top)	Ø26
19	Power supply wiring and control wiring intake (rear)	Ø29
20	Power supply wiring and control wiring intake (top)	Ø29

**NOTES**

1. Location of nameplate  
Bottom of the fan housing inside the suction grille
2. When installing a wireless controller, there will be a receiver on this location. For details, see the drawing of the wireless controller.
3. Do not place any objects under the indoor unit. In case of high humidity (>80%), clogged drain outlets, or dirty air filters, condensate may drop out.

**3D106574A**

**FHA50A9**

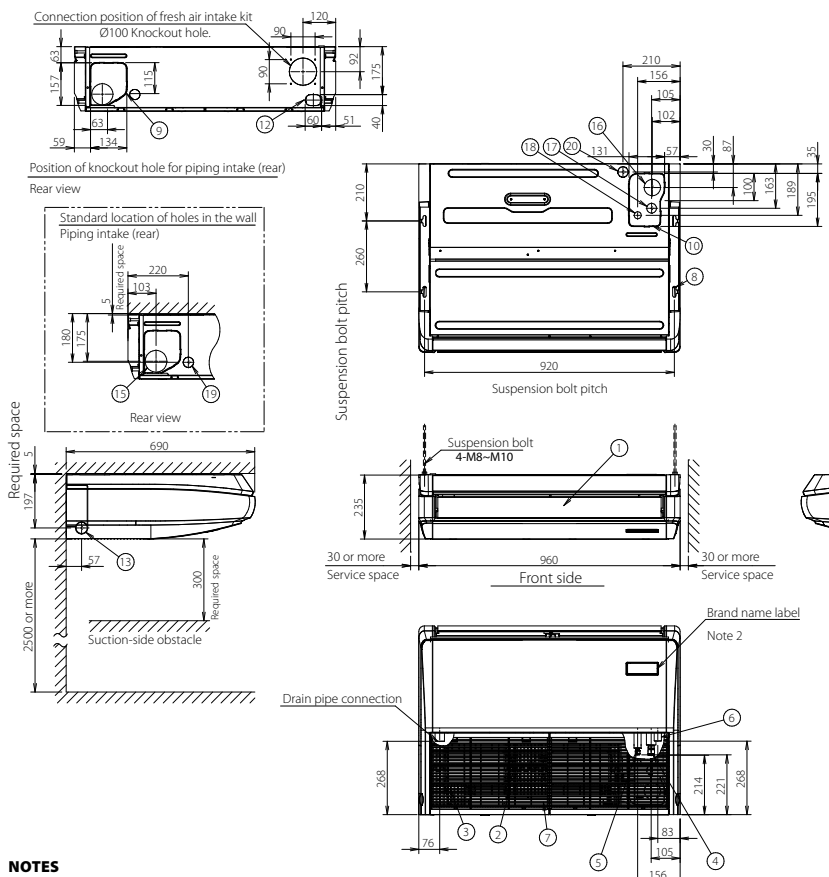

Number	Name	Description
1	Air discharge grille	
2	Air suction grille	
3	Air filter	
4	Gas pipe connection Ø12.7 flare	
5	Liquid pipe connection Ø6.4 flare	
6	Drain pipe connection	VP20
7	Terminal block with earth terminal Located inside of the unit	M4
8	Metal hanger	
9	Position of knockout hole	Rear side
10	Position of knockout hole	Top
11	Piping intake (right)	Knockout hole
12	Drain piping intake (left-rear)	Knockout hole
13	Drain piping intake (left)	Knockout hole
14	Drain piping intake (right)	Knockout hole
15	Standard location of holes in the wall Piping intake (rear)	Ø100
16	Drain piping intake (top)	Ø60
17	Gas piping intake (top)	Ø36
18	Liquid piping intake (top)	Ø26
19	Power supply wiring and control wiring intake (rear)	Ø29
20	Power supply wiring and control wiring intake (top)	Ø29

**NOTES**

1. Location of nameplate  
Bottom of the fan housing inside the suction grille
2. When installing a wireless controller, there will be a receiver on this location. For details, see the drawing of the wireless controller.
3. Do not place any objects under the indoor unit. In case of high humidity (>80%), clogged drain outlets, or dirty air filters, condensate may drop out.

**3D109224A**

Detailed technical drawings

FHA60A9

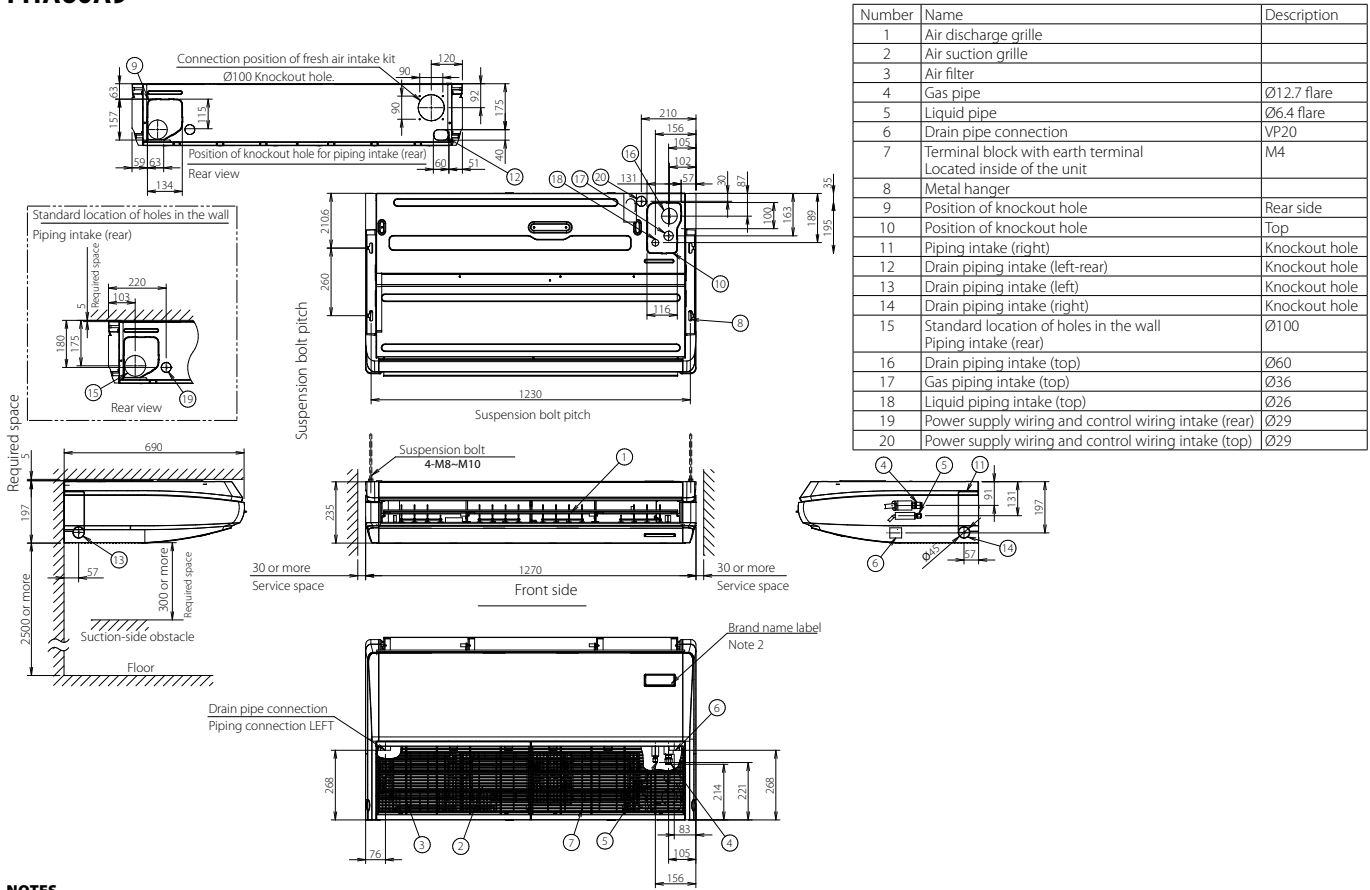

NOTES

1. Location of nameplate  
Bottom of the fan housing inside the suction grille
2. When installing a wireless controller, there will be a receiver on this location. For details, see the drawing of the wireless controller.
3. Do not place any objects under the indoor unit. In case of high humidity (>80%), clogged drain outlets, or dirty air filters, condensate may drop out.

3D106552

FHA71A9

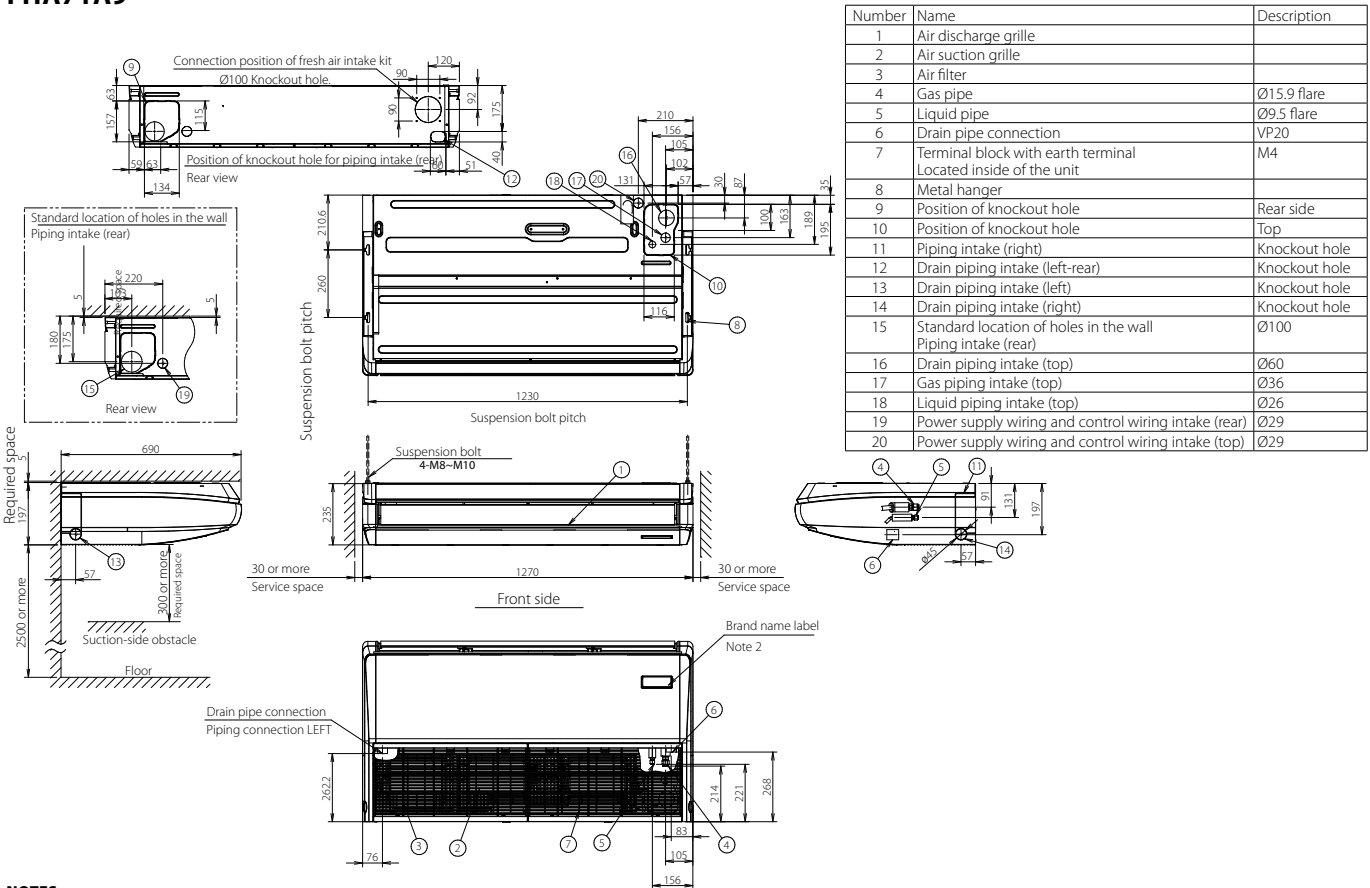

NOTES

1. Location of nameplate  
Bottom of the fan housing inside the suction grille
2. When installing a wireless controller, there will be a receiver on this location. For details, see the drawing of the wireless controller.
3. Do not place any objects under the indoor unit. In case of high humidity (>80%), clogged drain outlets, or dirty air filters, condensate may drop out.

3D109222





FHA100-140A

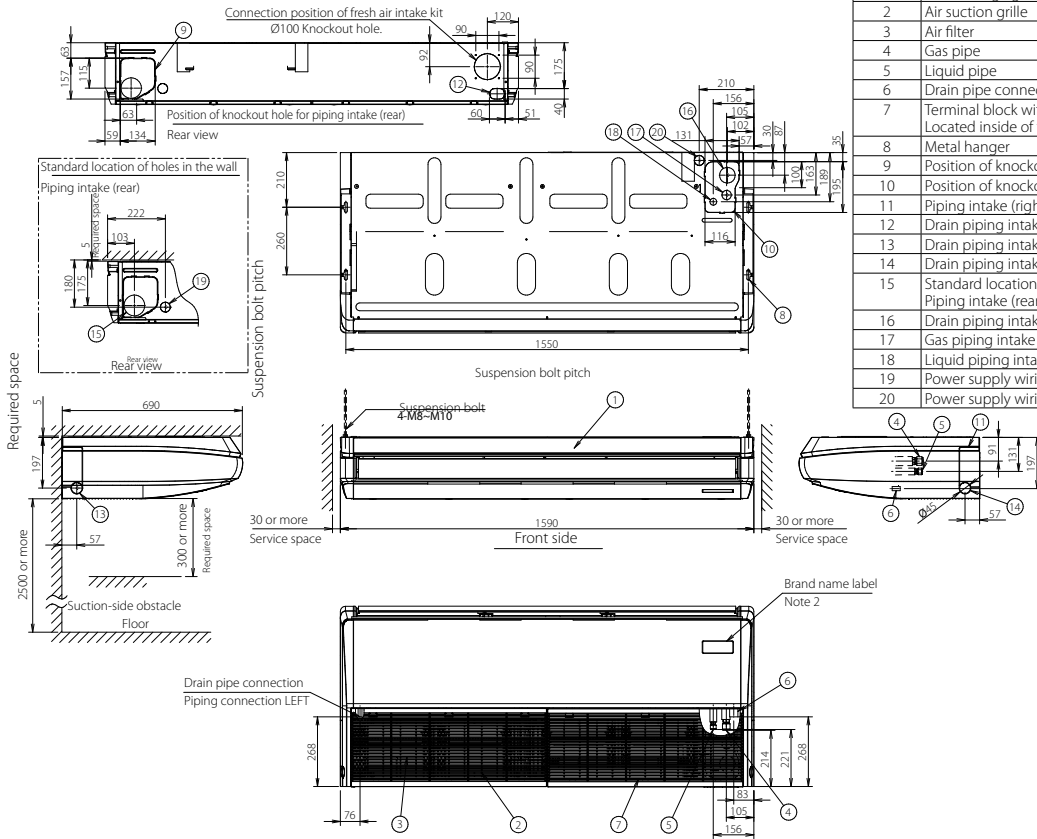

Number	Name	Description
1	Air discharge grille	
2	Air suction grille	
3	Air filter	
4	Gas pipe	Ø15.9 flare
5	Liquid pipe	Ø9.5 flare
6	Drain pipe connection	VP20
7	Terminal block with earth terminal	Located inside of the unit
8	Metal hanger	
9	Position of knockout hole	Rear side
10	Position of knockout hole	Top
11	Piping intake (right)	Knockout hole
12	Drain piping intake (left)	Knockout hole
13	Drain piping intake (right)	Knockout hole
14	Drain piping intake (left-rear)	Knockout hole
15	Standard location of holes in the wall	Ø100
16	Drain piping intake (top)	Ø60
17	Gas piping intake (top)	Ø36
18	Liquid piping intake (top)	Ø26
19	Power supply wiring and control wiring intake (rear)	Ø29
20	Power supply wiring and control wiring intake (top)	Ø29

NOTES

1. Location of nameplate  
Bottom of the fan housing inside the suction grille
2. When installing a wireless controller, there will be a receiver on this location. For details, see the drawing of the wireless controller.
3. Do not place any objects under the indoor unit. In case of high humidity (>80%), clogged drain outlets, or dirty air filters, condensate may drop out.

3D106530A



## Detailed technical drawings

### FUA-A

When closing the air outlet, the required space is 30mm or more. Note (3)

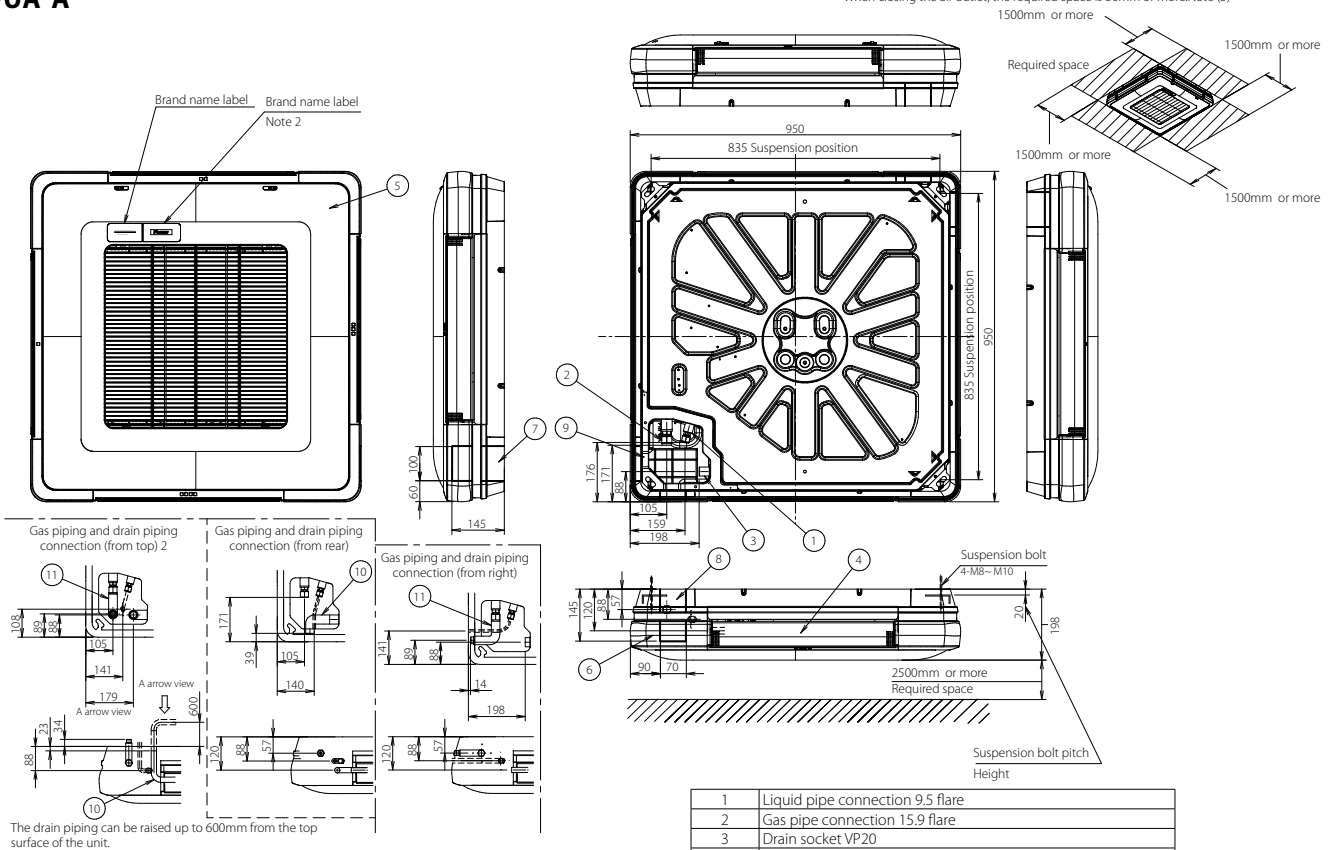

#### NOTES

1. The unit nameplate is located on the control box cover.
2. When installing a wireless controller, there will be a receiver on this location. For details, see the drawing of the wireless controller.
3. When closing the discharge grille in case of 2-way blow or 3-way blow, there are limitations to the piping connection direction. See the installation manual.
4. Do not place any objects under the indoor unit. In case of high humidity (>80%), clogged drain outlets, or dirty air filters, condensate may drop out.

1	Liquid pipe connection 9.5 flare
2	Gas pipe connection 15.9 flare
3	Drain socket VP20
4	Air discharge outlet
5	Air suction grille
6	Corner decoration cover
7	Piping connection right/ Wiring connection
8	Piping connection Rear/ Wiring connection
9	Pipe cover (top)
10	Drain pipe connection (outside diameter 26)
11	L-type piping kit (upward direction) 15.9 flared connection

**3D106356**



### FVA71A

This unit has to be fixed with fixing screws as shown below.  
In case of fixing it at the bottom  
In case vibration resistance is required, fix it at both the bottom and the rear.

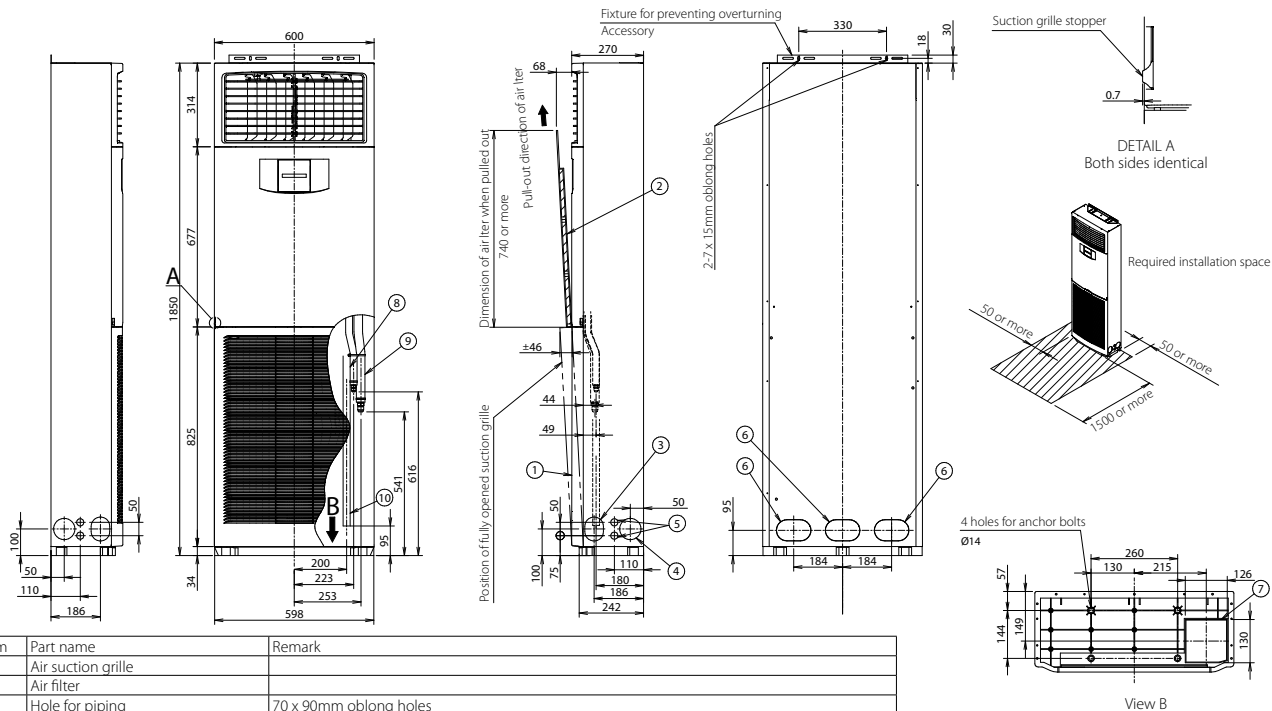

Item	Part name	Remark
1	Air suction grille	
2	Air filter	
3	Hole for piping	70 x 90mm oblong holes
4	Hole for piping	Knockout hole for recirculation piping or wiring of optional equipment Ø80
5	Hole for piping	Knockout hole for recirculation piping or wiring of optional equipment Ø27
6	Piping hole (rear)	80 x 130mm oblong holes
7	Piping hole (bottom)	126 x 130mm oblong holes
8	Liquid pipe	Ø9.5 flared connection
9	Gas pipe	Ø15.9 flared connection
10	Drain pipe connection	VP20

#### NOTES

1. The unit nameplate is located on the switch box cover, inside the suction grille.

**3D110397**

### FVA100-125-140A

This unit has to be fixed with fixing screws as shown below.  
In case of fixing it at the bottom  
In case vibration resistance is required, fix it at both the bottom and the rear.

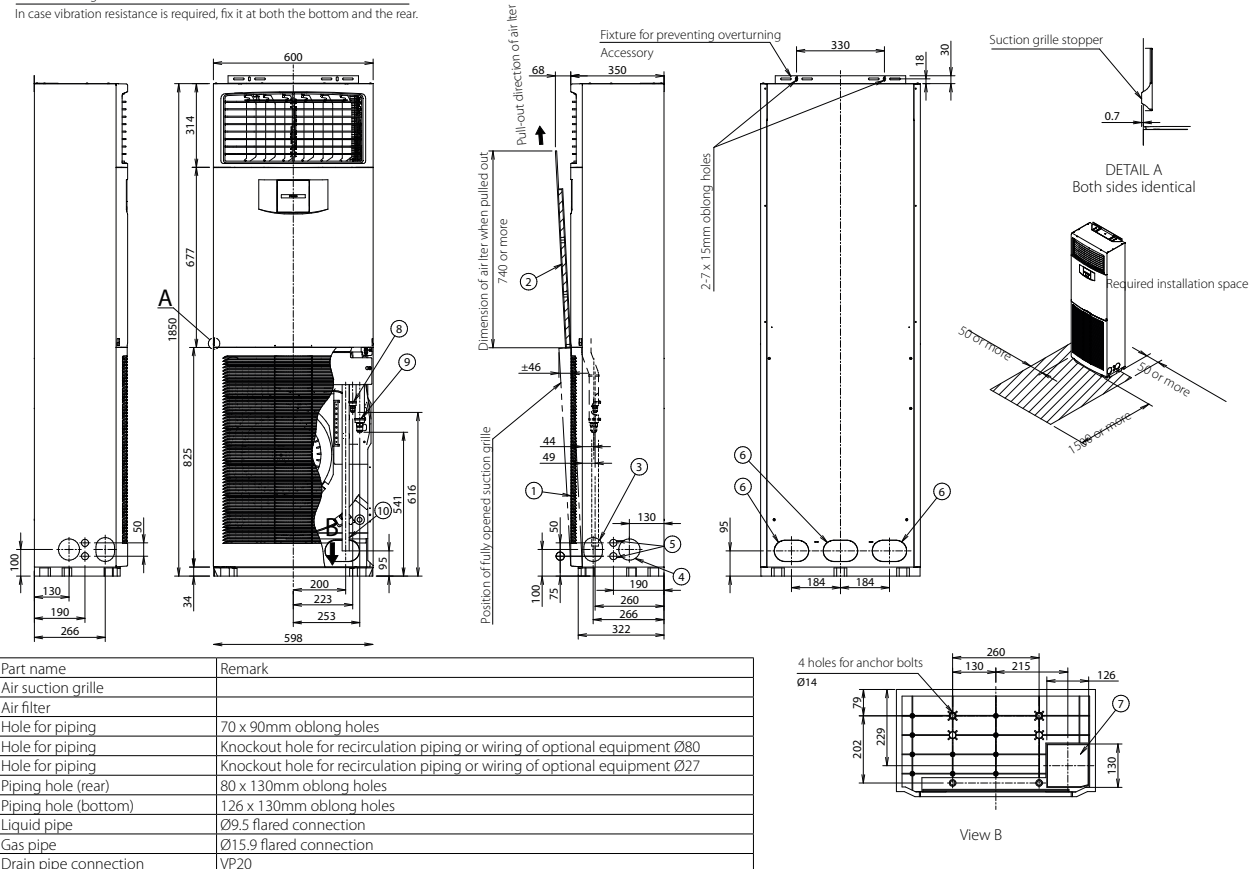

Item	Part name	Remark
1	Air suction grille	
2	Air filter	
3	Hole for piping	70 x 90mm oblong holes
4	Hole for piping	Knockout hole for recirculation piping or wiring of optional equipment Ø80
5	Hole for piping	Knockout hole for recirculation piping or wiring of optional equipment Ø27
6	Piping hole (rear)	80 x 130mm oblong holes
7	Piping hole (bottom)	126 x 130mm oblong holes
8	Liquid pipe	Ø9.5 flared connection
9	Gas pipe	Ø15.9 flared connection
10	Drain pipe connection	VP20

#### NOTES

1. The unit nameplate is located on the switch box cover, inside the suction grille.

**3D110703**

Detailed technical drawings

**FNA25-35A9**

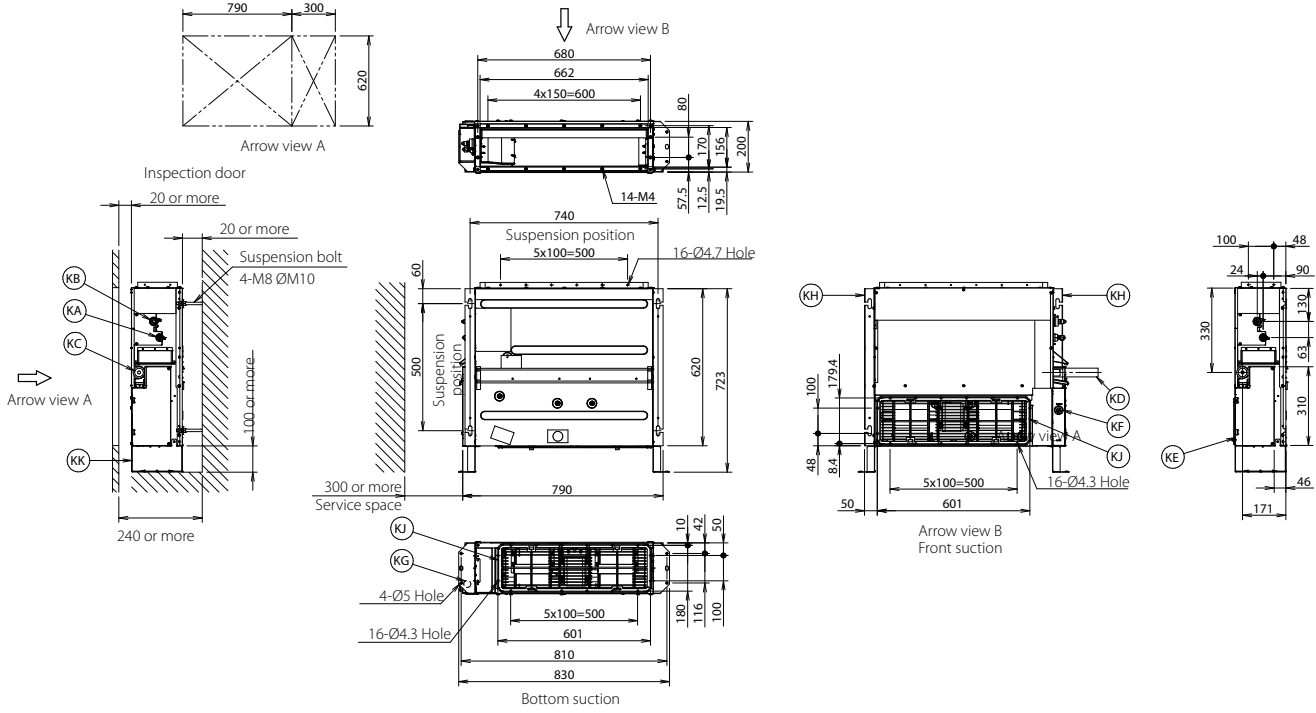

Item	Name	Description
KA	Liquid pipe connection port	Ø6.40 flared connection
KB	Gas pipe connection port	Ø9.50 flared connection
KC	Drain pipe connection	VP20 (OD Ø26, ID Ø20)
KD	Drain hose	ID Ø25
KE	Control box	/
KF	Transmission line	/
KG	Power supply connection	/
KH	Suspension bracket	/
KJ	Air filter	/
KK	Mounting foot	/

**NOTES**

1. When installing optional accessories, refer to their respective documentation.
2. The ceiling depth varies according to the documentation of the specific system.

**3D112885**

**FNA50-60A9**

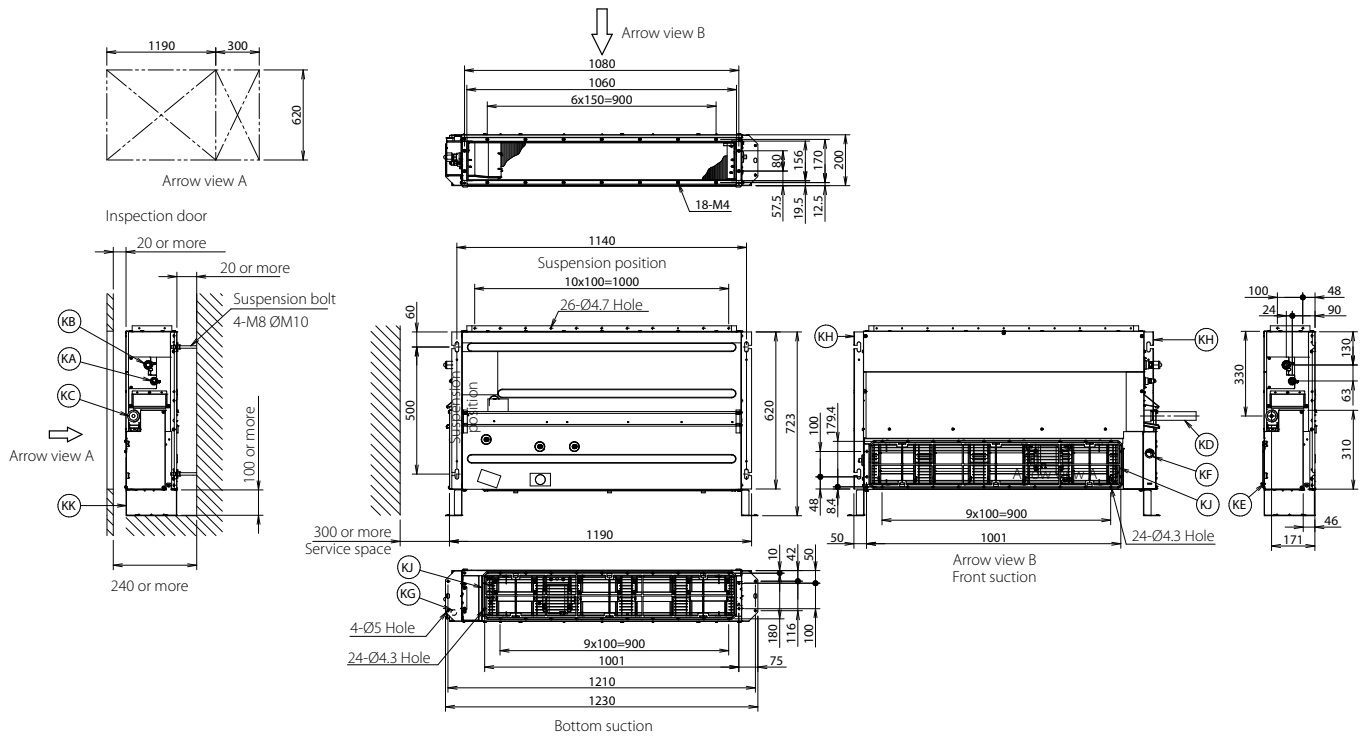

Item	Name	Description
KA	Liquid pipe connection port	Ø6.4 flared connection
KB	Gas pipe connection port	Ø12.70 flared connection
KC	Drain pipe connection	VP20 (OD Ø26, ID Ø20)
KD	Drain hose	ID Ø25
KE	Control box	/
KF	Transmission line	/
KG	Power supply connection	/
KH	Suspension bracket	/
KJ	Air filter	/
KK	Mounting foot	/

**NOTES**

1. When installing optional accessories, refer to their respective documentation.
2. The ceiling depth varies according to the documentation of the specific system.

**3D112884**



### FNA25-35A9

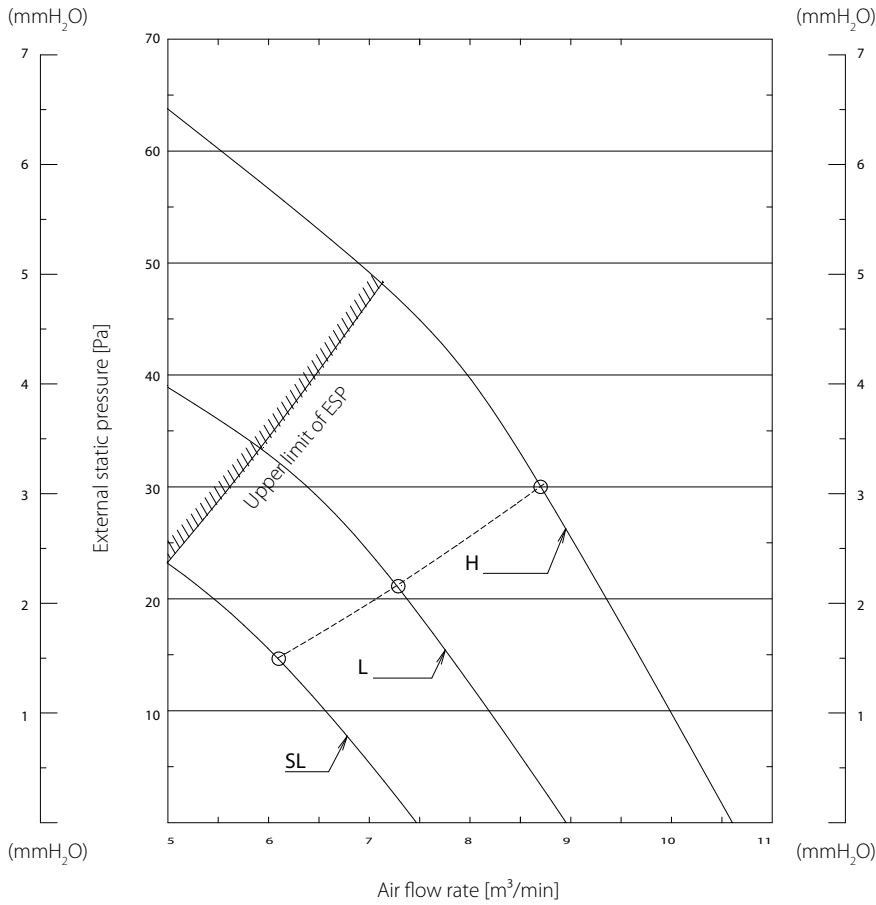

3D081327C

### FNA50A9

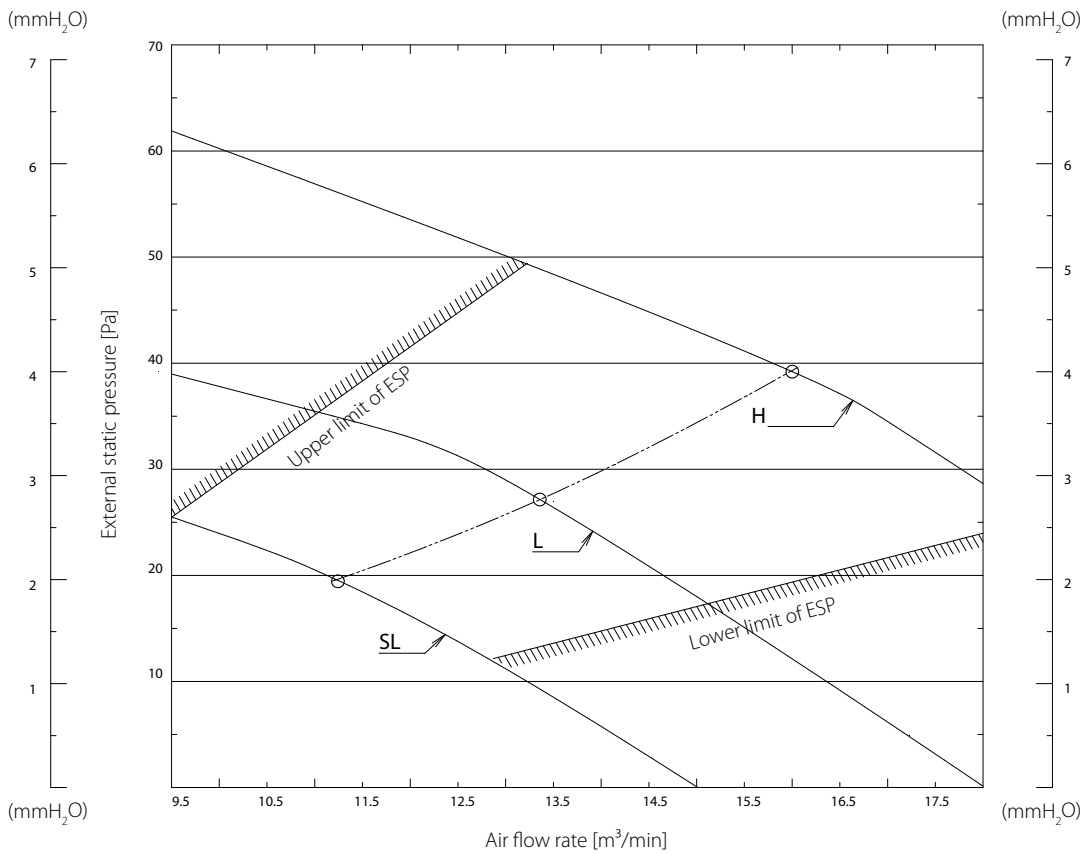

3D085960C

**FNA60A9**

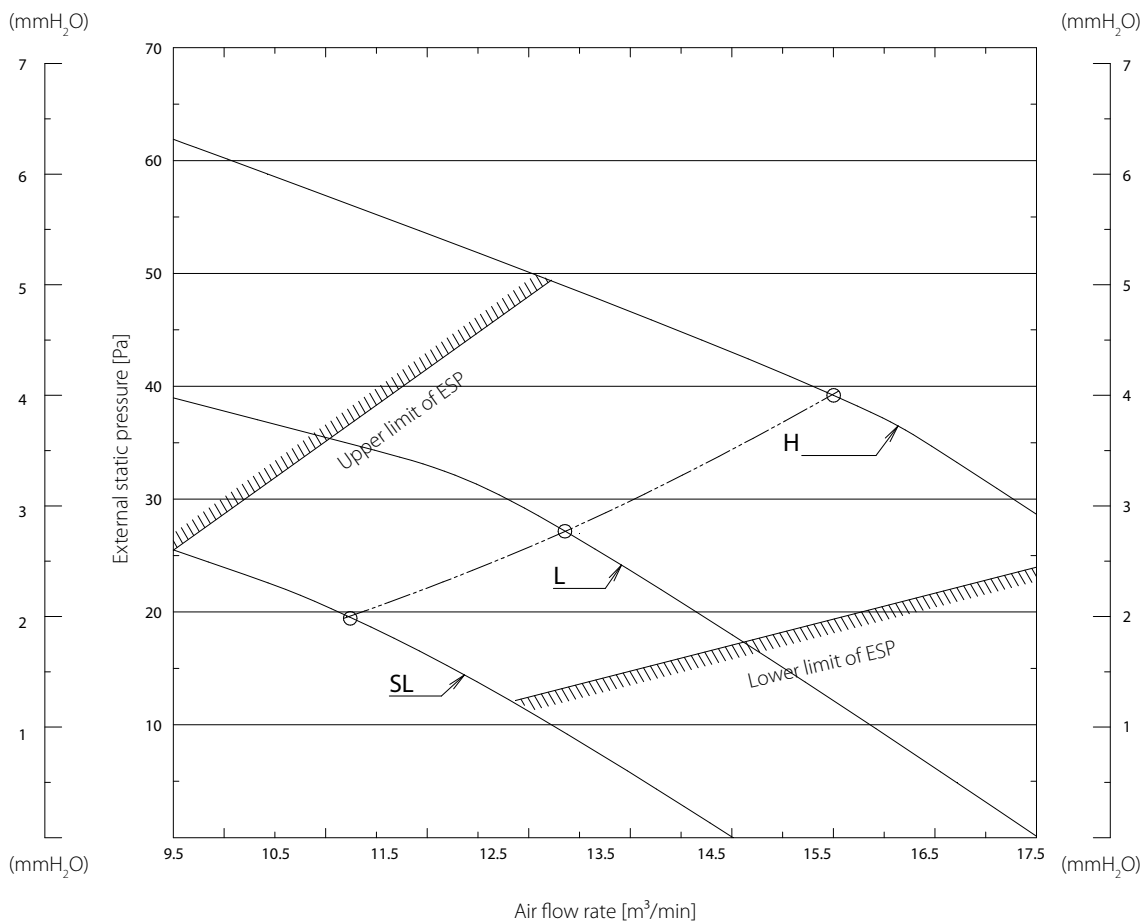

**3D081329C**



## Technical drawings

# Outdoor units

RZAG-A	192
RZAG-NV1/NY1	195
RZASG-MV1/MY1	204
RZA-D	200
AZAS-MV1/MY1	216

Detailed technical drawings

**RZAG35A**

Unit combination restrictions		Power supply		Compressor		OFM		IFM				
Outdoor unit	Indoor unit	Hz	Voltage	Voltage range	MCA	MFA	RHz	RLA	kW	FLA	kW	FLA
RZAG35A2V1B	FDXM35F3V1B9	50	220	MAX. 50Hz 264V MIN. 50Hz 198V	14.53	16	41	4.9	0.058	0.38	0.034	0.3
		50	230					4.7				
		50	240					4.5				
RZAG35A2V1B	FFA35A2VEB9	50	220	MAX. 50Hz 264V MIN. 50Hz 198V	14.43	16	38	4.6	0.058	0.38	0.050	0.2
		50	230					4.4				
		50	240					4.2				
RZAG35A2V1B	FBA35A2VEB9	50	220	MAX. 50Hz 264V MIN. 50Hz 198V	15.63	16	33	3.4	0.058	0.38	0.089	1.4
		50	230					3.3				
		50	240					3.2				
RZAG35A2V1B	FCAG35BVEB	50	220	MAX. 50Hz 264V MIN. 50Hz 198V	14.53	16	37	4.3	0.058	0.38	0.048	0.3
		50	230					4.1				
		50	240					3.9				
RZAG35A2V1B	FNA35A2VEB9	50	220	MAX. 50Hz 264V MIN. 50Hz 198V	14.73	16	41	4.9	0.058	0.38	0.034	0.5
		50	230					4.7				
		50	240					4.5				
RZAG35A2V1B	FTXM35N2V1B	50	220	MAX. 50Hz 264V MIN. 50Hz 198V	14.48	16	40	5.1	0.058	0.38	0.028	0.25
		50	230					4.9				
		50	240					4.7				
RZAG35A2V1B	FHA35AVEB99	50	220	MAX. 50Hz 264V MIN. 50Hz 198V	14.83	16	36	3.8	0.058	0.38	0.090	0.6
		50	230					3.6				
		50	240					3.5				
RZAG35A2V1B	FDXM50F3V1B9	50	220	MAX. 50Hz 264V MIN. 50Hz 198V	15.23	16	41	4.8	0.058	0.38	0.060	0.9
		50	230					4.6				
		50	240					4.4				
RZAG35A2V1B	FFA50A2VEB9	50	220	MAX. 50Hz 264V MIN. 50Hz 198V	14.63	16	38	4.6	0.058	0.38	0.050	0.4
		50	230					4.4				
		50	240					4.2				
RZAG35A2V1B	FBA50A2VEB9	50	220	MAX. 50Hz 264V MIN. 50Hz 198V	15.63	16	33	3.4	0.058	0.38	0.089	1.4
		50	230					3.3				
		50	240					3.2				
RZAG35A2V1B	FCAG50BVEB	50	220	MAX. 50Hz 264V MIN. 50Hz 198V	14.53	16	37	4.3	0.058	0.38	0.048	0.3
		50	230					4.1				
		50	240					3.9				
RZAG35A2V1B	FNA50A2VEB9	50	220	MAX. 50Hz 264V MIN. 50Hz 198V	14.73	16	41	4.8	0.058	0.38	0.060	0.5
		50	230					4.6				
		50	240					4.4				
RZAG35A2V1B	FTXM50N2V1B	50	220	MAX. 50Hz 264V MIN. 50Hz 198V	14.83	16	40	5.0	0.058	0.38	0.046	0.6
		50	230					4.8				
		50	240					4.6				
RZAG35A2V1B	FHA50AVEB99	50	220	MAX. 50Hz 264V MIN. 50Hz 198V	14.83	16	36	3.8	0.058	0.38	0.090	0.6
		50	230					3.6				
		50	240					3.5				
RZAG35A2V1B	FTXM35R2V1B	50	220	MAX. 50Hz 264V MIN. 50Hz 198V	14.53	16	40	5.1	0.058	0.38	0.030	0.3
		50	230					4.9				
		50	240					4.7				
RZAG35A2V1B	FTXM35R5V1B	50	220	MAX. 50Hz 264V MIN. 50Hz 198V	14.53	16	40	5.1	0.058	0.38	0.030	0.3
		50	230					4.9				
		50	240					4.7				
RZAG35A2V1B	FTXM50R2V1B	50	220	MAX. 50Hz 264V MIN. 50Hz 198V	14.83	16	40	5.0	0.058	0.38	0.046	0.3
		50	230					4.8				
		50	240					4.6				

RZAG35A

**3D118439D**

**RZAG50A**

Unit combination restrictions		Power supply		Compressor		OFM		IFM				
Outdoor unit	Indoor unit	Hz	Voltage	Voltage range	MCA	MFA	RHz	RLA	kW	FLA	kW	FLA
RZAG50A2V1B	FDXM50F3V1B9	50	220	MAX. 50Hz 264V MIN. 50Hz 198V	15.23	16	57	5.4	0.058	0.38	0.060	0.9
		50	230					5.2				
		50	240					5.0				
RZAG50A2V1B	FFA50A2VEB9	50	220	MAX. 50Hz 264V MIN. 50Hz 198V	14.63	16	62	5.5	0.058	0.38	0.050	0.4
		50	230					5.2				
		50	240					5.0				
RZAG50A2V1B	FBA50A2VEB9	50	220	MAX. 50Hz 264V MIN. 50Hz 198V	15.63	16	53	6.8	0.058	0.38	0.089	1.4
		50	230					6.5				
		50	240					6.2				
RZAG50A2V1B	FCAG50BVEB	50	220	MAX. 50Hz 264V MIN. 50Hz 198V	14.53	16	56	7.3	0.058	0.38	0.048	0.3
		50	230					7.0				
		50	240					6.7				
RZAG50A2V1B	FNA50A2VEB9	50	220	MAX. 50Hz 264V MIN. 50Hz 198V	14.73	16	57	5.4	0.058	0.38	0.060	0.5
		50	230					5.2				
		50	240					5.0				
RZAG50A2V1B	FTXM50N2V1B	50	220	MAX. 50Hz 264V MIN. 50Hz 198V	14.83	16	54	6.5	0.058	0.38	0.046	0.6
		50	230					6.2				
		50	240					5.9				
RZAG50A2V1B	FHA50AVEB99	50	220	MAX. 50Hz 264V MIN. 50Hz 198V	14.83	16	52	5.0	0.058	0.38	0.090	0.6
		50	230					4.8				
		50	240					4.6				
RZAG50A2V1B	FDXM60F3V1B9	50	220	MAX. 50Hz 264V MIN. 50Hz 198V	15.23	16	57	5.4	0.058	0.38	0.060	0.9
		50	230					5.2				
		50	240					5.0				
RZAG50A2V1B	FFA60A2VEB9	50	220	MAX. 50Hz 264V MIN. 50Hz 198V	14.83	16	62	5.5	0.058	0.38	0.050	0.6
		50	230					5.2				
		50	240					5.0				
RZAG50A2V1B	FBA60A2VEB9	50	220	MAX. 50Hz 264V MIN. 50Hz 198V	15.53	16	53	6.9	0.058	0.38	0.070	1.3
		50	230					6.6				
		50	240					6.3				
RZAG50A2V1B	FCAG60BVEB	50	220	MAX. 50Hz 264V MIN. 50Hz 198V	14.53	16	56	7.3	0.058	0.38	0.048	0.3
		50	230					7.0				
		50	240					6.7				
RZAG50A2V1B	FNA60A2VEB9	50	220	MAX. 50Hz 264V MIN. 50Hz 198V	14.83	16	57	5.4	0.058	0.38	0.060	0.6
		50	230					5.2				
		50	240					5.0				
RZAG50A2V1B	FTXM60N2V1B	50	220	MAX. 50Hz 264V MIN. 50Hz 198V	14.83	16	54	6.5	0.058	0.38	0.046	0.6
		50	230					6.2				
		50	240					5.9				
RZAG50A2V1B	FHA60AVEB99	50	220	MAX. 50Hz 264V MIN. 50Hz 198V	14.83	16	52	5.0	0.058	0.38	0.091	0.6
		50	230					4.8				
		50	240					4.6				
RZAG50A2V1B	FTXM50R2V1B	50	220	MAX. 50Hz 264V MIN. 50Hz 198V	14.83	16	54	6.5	0.058	0.38	0.046	0.6
		50	230					6.2				
		50	240					5.9				
RZAG50A2V1B	FTXM60R2V1B	50	220	MAX. 50Hz 264V MIN. 50Hz 198V	14.83	16	54	6.5	0.058	0.38	0.046	0.6
		50	230					6.2				
		50	240					5.9				

RZAG50A

**3D118440C**





## RZAG60A

Unit combination restrictions		Power supply		Compressor		OFM		IFM				
Outdoor unit	Indoor unit	Hz	Voltage	Voltage range	MCA	MFA	RHz	RLA	kW	FLA	kW	FLA
RZAG60A2V1B	FDXM60F3V1B9	50	220	MAX. 50Hz 264V MIN. 50Hz 198V	17.10	20	70	7.3	0.058	0.38	0.060	0.9
		50	230					6.9				
		50	240					6.7				
RZAG60A2V1B	FFA60A2VEB9	50	220	MAX. 50Hz 264V MIN. 50Hz 198V	16.70	20	70	9.0	0.058	0.38	0.050	0.6
		50	230					8.6				
		50	240					8.2				
RZAG60A2V1B	FBA60A2VEB9	50	220	MAX. 50Hz 264V MIN. 50Hz 198V	17.40	20	65	7.0	0.058	0.38	0.070	1.3
		50	230					6.7				
		50	240					6.4				
RZAG60A2V1B	FCAG60BVEB	50	220	MAX. 50Hz 264V MIN. 50Hz 198V	16.40	20	72	7.5	0.058	0.38	0.048	0.3
		50	230					7.2				
		50	240					6.9				
RZAG60A2V1B	FNA60A2VEB9	50	220	MAX. 50Hz 264V MIN. 50Hz 198V	16.70	20	70	9.0	0.058	0.38	0.060	0.6
		50	230					8.6				
		50	240					8.3				
RZAG60A2V1B	FTXM60N2V1B	50	220	MAX. 50Hz 264V MIN. 50Hz 198V	16.70	20	71	8.4	0.058	0.38	0.046	0.6
		50	230					8.1				
		50	240					7.7				
RZAG60A2V1B	FHA60AVEB99	50	220	MAX. 50Hz 264V MIN. 50Hz 198V	16.70	20	67	8.1	0.058	0.38	0.091	0.6
		50	230					7.7				
		50	240					7.4				
RZAG60A2V1B	FBA71A2VEB9	50	220	MAX. 50Hz 264V MIN. 50Hz 198V	17.40	20	65	8.9	0.058	0.38	0.070	1.3
		50	230					8.5				
		50	240					8.1				
RZAG60A2V1B	FCAG71BVEB	50	220	MAX. 50Hz 264V MIN. 50Hz 198V	16.40	20	72	7.5	0.058	0.38	0.054	0.3
		50	230					7.2				
		50	240					6.9				
RZAG60A2V1B	FTXM71N2V1B	50	220	MAX. 50Hz 264V MIN. 50Hz 198V	16.70	20	71	8.4	0.058	0.38	0.052	0.6
		50	230					8.0				
		50	240					7.7				
RZAG60A2V1B	FHA71AVEB99	50	220	MAX. 50Hz 264V MIN. 50Hz 198V	16.90	20	67	8.1	0.058	0.38	0.091	0.8
		50	230					7.7				
		50	240					7.4				
RZAG60A2V1B	FTXM60R2V1B	50	220	MAX. 50Hz 264V MIN. 50Hz 198V	16.70	20	71	8.4	0.058	0.38	0.046	0.6
		50	230					8.1				
		50	240					7.7				
RZAG60A2V1B	FTXM71R2V1B	50	220	MAX. 50Hz 264V MIN. 50Hz 198V	16.70	20	71	8.4	0.058	0.38	0.052	0.6
		50	230					8.0				
		50	240					7.7				

RZAG60A

**3D118441C**

## RZAG-A

Symbols	Notes
MCA Minimum Circuit Ampere [A]	<ol style="list-style-type: none"> <li>The RLA is based on the following conditions. Outdoor temperature 35°C DB Indoor temperature 27°C DB / 19°C WB</li> <li>Select the wire size according to the MCA.</li> <li>The maximum allowable voltage that is unbalanced between phases is 2%.</li> <li>Use a circuit breaker instead of a fuse.</li> </ol>
MFA Maximum Fuse Ampere [A]	
RLA Rated load amps [A]	
OFM Outdoor fan motor	
IFM Indoor fan motor	
FLA Full Load Ampere [A]	
kW Fan motor rated output [kW]	
RHz Rated operating frequency [Hz]	

**3D118439 - 3D118440 - 3D118441**

**RZAG35A**

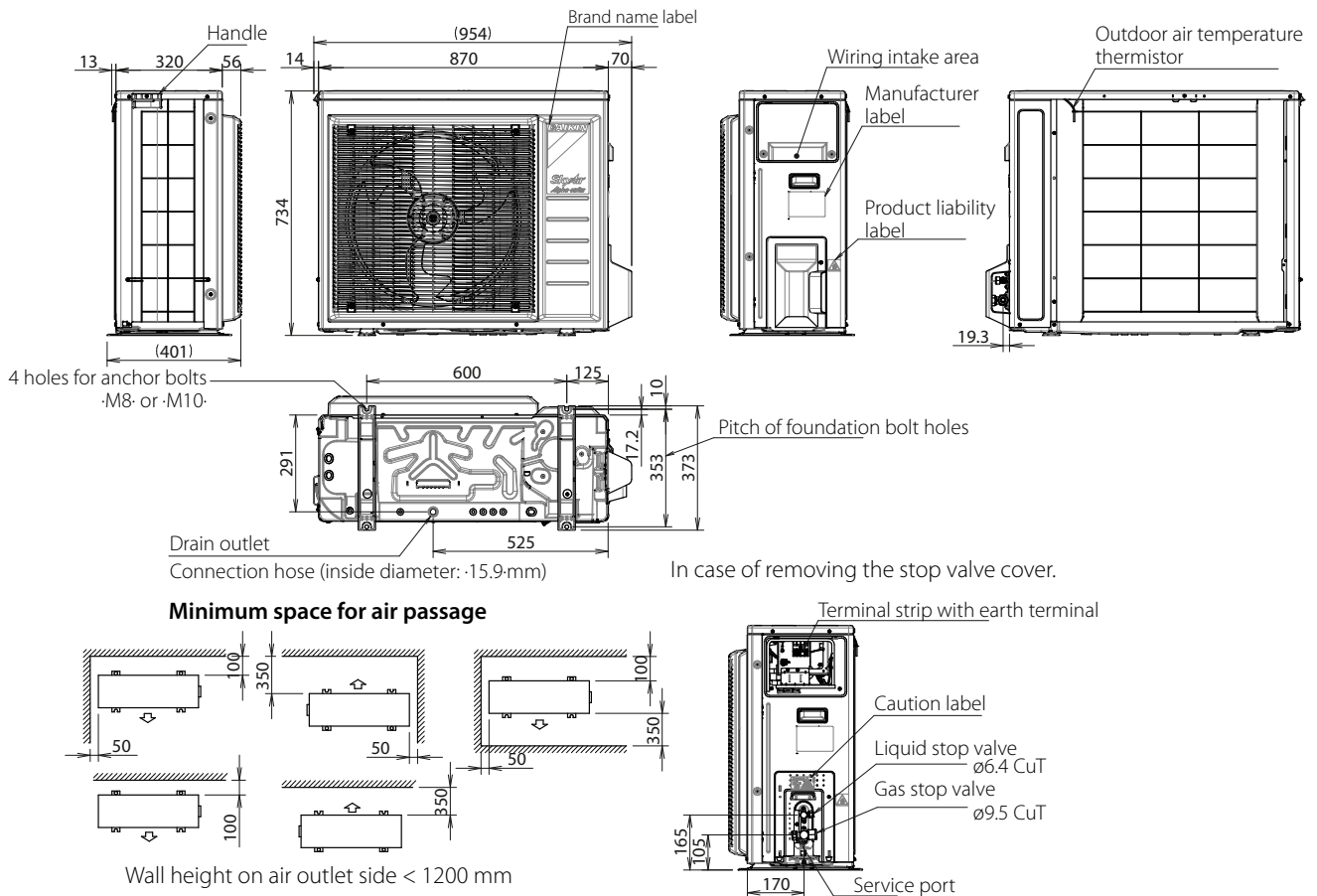

**3D118381A**

**RZAG50-60A**

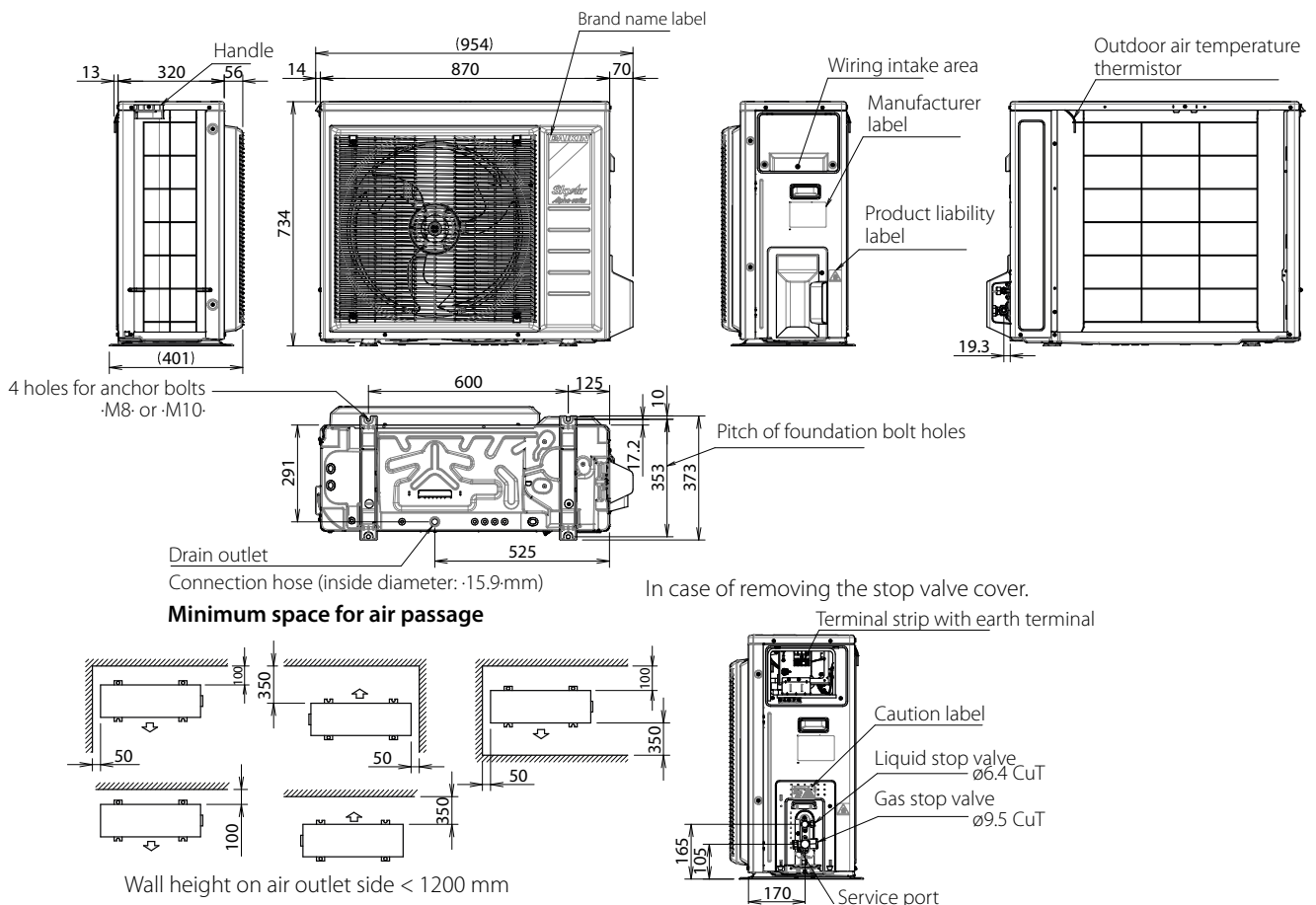

**3D118380A**



## RZAG71-100NV1 COMFORT COOLING

Indoor	Outdoor	Power supply	Voltage range	MCA	TOCA	MFA	Compressor		OFM		IFM						
							MSC	RLA	kW	FLA	kW	FLA					
FCAHG71HVEB	RZAG71N7V1B	50Hz ~ 220-240V	Minimum: ·198 V·	Maximum ·264 V·	17.7	-	20	-	15.5	0.234	0.8	0.091	0.7				
FCAG35BVEB	x2 RZAG71N7V1B				17.6	-	20	-	15.5	0.234	0.8	0.044 x2	0.3 x2	0.4			
FCAG71BVEB	RZAG71N7V1B				17.4	-	20	-	15.5	0.234	0.8	0.054	0.4	0.4			
FFA35A2VEB	x2 RZAG71N7V1B				17.4	-	20	-	15.5	0.234	0.8	0.050 x2	0.2 x2	0.2 x2			
FBA35A2VEB	x2 RZAG71N7V1B				19.9	-	20	-	15.5	0.234	0.8	0.089 x2	1.4 x2	1.4 x2			
FBA71A2VEB	RZAG71N7V1B				18.3	-	20	-	15.5	0.234	0.8	0.070	1.3	1.3			
FNA35A2VEB	x2 RZAG71N7V1B				18.0	-	20	-	15.5	0.234	0.8	0.034 x2	0.5 x2	0.5 x2			
FUA71AVEB9	RZAG71N7V1B				17.9	-	20	-	15.5	0.234	0.8	0.046	0.9	0.9			
FAA71BUV1B	RZAG71N7V1B				17.5	-	20	-	15.5	0.234	0.8	0.048	0.5	0.5			
FVA71AMVEB	RZAG71N7V1B				17.8	-	20	-	15.5	0.234	0.8	0.117	0.8	0.8			
FDXM35F3V1B	x2 RZAG71N7V1B				17.6	-	20	-	15.5	0.234	0.8	0.034 x2	0.3 x2	0.3 x2			
FHA35AVEB99	x2 RZAG71N7V1B				18.2	-	20	-	15.5	0.234	0.8	0.060 x2	0.6 x2	0.6 x2			
FHA71AVEB99	RZAG71N7V1B				17.8	-	20	-	15.5	0.234	0.8	0.091	0.8	0.8			
FCAHG100HVEB	RZAG100N7V1B				50Hz ~ 220-240V	Minimum: ·198 V·	Maximum ·264 V·	22.2	-	32	-	18.8	0.234	1.2	0.221	1.3	
FCAG35BVEB	x3 RZAG100N7V1B							21.7	-	32	-	18.8	0.234	1.2	0.044 x3	0.3 x3	0.3 x3
FCAG50BVEB	x2 RZAG100N7V1B							21.4	-	32	-	18.8	0.234	1.2	0.039 x2	0.3 x2	0.3 x2
FCAG100BVEB	RZAG100N7V1B							21.5	-	32	-	18.8	0.234	1.2	0.117	0.7	0.7
FFA35A2VEB	x3 RZAG100N7V1B							21.4	-	32	-	18.8	0.234	1.2	0.050 x3	0.2 x3	0.2 x3
FFA50A2VEB	x2 RZAG100N7V1B	21.6	-	32				-	18.8	0.234	1.2	0.050 x2	0.4 x2	0.4 x2			
FBA35A2VEB	x3 RZAG100N7V1B	25.2	-	32				-	18.8	0.234	1.2	0.089 x3	1.4 x3	1.4 x3			
FBA50A2VEB	x2 RZAG100N7V1B	23.7	-	32				-	18.8	0.234	1.2	0.089 x2	1.4 x2	1.4 x2			
FBA100A2VEB	RZAG100N7V1B	24.4	-	32				-	18.8	0.234	1.2	0.127	3.5	3.5			
FNA35A2VEB	x3 RZAG100N7V1B	22.4	-	32				-	18.8	0.234	1.2	0.034 x3	0.5 x3	0.5 x3			
FNA50A2VEB	x2 RZAG100N7V1B	21.8	-	32				-	18.8	0.234	1.2	0.060 x2	0.5 x2	0.5 x2			
FUA100AVEB9	RZAG100N7V1B	22.2	-	32				-	18.8	0.234	1.2	0.106	1.3	1.3			
FAA100BUV1B	RZAG100N7V1B	21.7	-	32				-	18.8	0.234	1.2	0.064	0.5	0.5			
FVA100AMVEB	RZAG100N7V1B	22.4	-	32				-	18.8	0.234	1.2	0.238	1.5	1.5			
FDXM35F3V1B	x3 RZAG100N7V1B	21.7	-	32				-	18.8	0.234	1.2	0.034 x3	0.3 x3	0.3 x3			
FDXM50F3V1B	x2 RZAG100N7V1B	22.7	-	32				-	18.8	0.234	1.2	0.060 x2	0.9 x2	0.9 x2			
FHA35AVEB99	x3 RZAG100N7V1B	22.7	-	32				-	18.8	0.234	1.2	0.060 x3	0.6 x3	0.6 x3			
FHA50AVEB99	x2 RZAG100N7V1B	22.0	-	32				-	18.8	0.234	1.2	0.060 x2	0.6 x2	0.6 x2			
FHA100AVEB9	RZAG100N7V1B	22.2	-	32	-	18.8	0.234	1.2	0.150	1.3	1.3						

\* Use a separate power supply for the indoor unit. The value between brackets is the MCA of the outdoor unit. For the MCA of the indoor unit, see the installation manual of the indoor unit.

RZAG71-100NV1

3D120943C

## RZAG125-140NV1 COMFORT COOLING

Indoor	Outdoor	Power supply	Voltage range	MCA	TOCA	MFA	Compressor		OFM		IFM			
							MSC	RLA	kW	FLA	kW	FLA		
FCAHG125HVEB	RZAG125N7V1B	50Hz ~ 220-240V	Minimum: ·198 V·	Maximum ·264 V·	27.5	-	32	-	23.8	0.234	1.2	0.244	1.4	
FCAG35BVEB	x4 RZAG125N7V1B				27.2	-	32	-	23.8	0.234	1.2	0.044 x4	0.3 x4	0.3 x4
FCAG50BVEB	x3 RZAG125N7V1B				26.9	-	32	-	23.8	0.234	1.2	0.039 x3	0.3 x3	0.3 x3
FCAG60BVEB	x2 RZAG125N7V1B				26.6	-	32	-	23.8	0.234	1.2	0.044 x2	0.3 x2	0.3 x2
FCAG125BVEB	RZAG125N7V1B				27.0	-	32	-	23.8	0.234	1.2	0.168	1.0	1.0
FFA35A2VEB	x4 RZAG125N7V1B				26.8	-	32	-	23.8	0.234	1.2	0.050 x4	0.2 x4	0.2 x4
FFA50A2VEB	x3 RZAG125N7V1B				27.2	-	32	-	23.8	0.234	1.2	0.050 x3	0.4 x3	0.4 x3
FFA60A2VEB	x2 RZAG125N7V1B				27.2	-	32	-	23.8	0.234	1.2	0.050 x2	0.6 x2	0.6 x2
FBA35A2VEB	x4 RZAG125N7V1B				31.8	-	32	-	23.8	0.234	1.2	0.089 x4	1.4 x4	1.4 x4
FBA50A2VEB	x3 RZAG125N7V1B				30.4	-	32	-	23.8	0.234	1.2	0.089 x3	1.4 x3	1.4 x3
FBA60A2VEB	x2 RZAG125N7V1B				28.7	-	32	-	23.8	0.234	1.2	0.070 x2	1.3 x2	1.3 x2
FBA125A2VEB	RZAG125N7V1B				30.1	-	32	-	23.8	0.234	1.2	0.187	3.9	3.9
FNA35A2VEB	x4 RZAG125N7V1B				28.1	-	32	-	23.8	0.234	1.2	0.034 x4	0.5 x4	0.5 x4
FNA50A2VEB	x3 RZAG125N7V1B				27.6	-	32	-	23.8	0.234	1.2	0.060 x3	0.5 x3	0.5 x3
FNA60A2VEB	x2 RZAG125N7V1B				27.2	-	32	-	23.8	0.234	1.2	0.060 x2	0.6 x2	0.6 x2
FUA125AVEB9	RZAG125N7V1B				27.5	-	32	-	23.8	0.234	1.2	0.106	1.4	1.4
FDA125AVEB	RZAG125N7V1B				28.2	-	32	-	23.8	0.234	1.2	0.350	2.1	2.1
FVA125AMVEB	RZAG125N7V1B				27.6	-	32	-	23.8	0.234	1.2	0.238	1.5	1.5
FDXM35F3V1B	x4 RZAG125N7V1B	27.2	-	32	-	23.8	0.234	1.2	0.034 x4	0.3 x4	0.3 x4			
FDXM50F3V1B	x3 RZAG125N7V1B	28.8	-	32	-	23.8	0.234	1.2	0.060 x3	0.9 x3	0.9 x3			
FDXM60F3V1B	x2 RZAG125N7V1B	27.9	-	32	-	23.8	0.234	1.2	0.060 x2	0.9 x2	0.9 x2			
FHA35AVEB99	x4 RZAG125N7V1B	28.5	-	32	-	23.8	0.234	1.2	0.060 x4	0.6 x4	0.6 x4			
FHA50AVEB99	x3 RZAG125N7V1B	27.9	-	32	-	23.8	0.234	1.2	0.060 x3	0.6 x3	0.6 x3			
FHA60AVEB99	x2 RZAG125N7V1B	27.2	-	32	-	23.8	0.234	1.2	0.091 x2	0.6 x2	0.6 x2			
FHA125AVEB9	RZAG125N7V1B	27.6	-	32	-	23.8	0.234	1.2	0.150	1.5	1.5			
FCAHG71HVEB	x2 RZAG140N7V1B	50Hz ~ 220-240V	Minimum: ·198 V·	Maximum ·264 V·	27.5	-	32	-	23.6	0.234	1.4	0.091 x2	0.7 x2	
FCAHG140HVEB	RZAG140N7V1B				27.5	-	32	-	23.6	0.234	1.4	0.244	1.4	1.4
FCAG35BVEB	x4 RZAG140N7V1B				27.2	-	32	-	23.6	0.234	1.4	0.044 x4	0.3 x4	0.3 x4
FCAG50BVEB	x3 RZAG140N7V1B				26.9	-	32	-	23.6	0.234	1.4	0.039 x3	0.3 x3	0.3 x3
FCAG71BVEB	x2 RZAG140N7V1B				26.8	-	32	-	23.6	0.234	1.4	0.054 x2	0.4 x2	0.4 x2
FCAG140BVEB	RZAG140N7V1B				27.4	-	32	-	23.6	0.234	1.4	0.168	1.3	1.3
FFA35A2VEB	x4 RZAG140N7V1B				26.8	-	32	-	23.6	0.234	1.4	0.050 x4	0.2 x4	0.2 x4
FFA50A2VEB	x3 RZAG140N7V1B				27.2	-	32	-	23.6	0.234	1.4	0.050 x3	0.4 x3	0.4 x3
FBA35A2VEB	x4 RZAG140N7V1B				31.8	-	32	-	23.6	0.234	1.4	0.089 x4	1.4 x4	1.4 x4
FBA50A2VEB	x3 RZAG140N7V1B				30.4	-	32	-	23.6	0.234	1.4	0.089 x3	1.4 x3	1.4 x3
FBA71A2VEB	x2 RZAG140N7V1B				28.7	-	32	-	23.6	0.234	1.4	0.070 x2	1.3 x2	1.3 x2
FBA140A2VEB	RZAG140N7V1B				30.1	-	32	-	23.6	0.234	1.4	0.187	3.9	3.9
FNA35A2VEB	x4 RZAG140N7V1B				28.1	-	32	-	23.6	0.234	1.4	0.034 x4	0.5 x4	0.5 x4
FNA50A2VEB	x3 RZAG140N7V1B				27.6	-	32	-	23.6	0.234	1.4	0.060 x3	0.5 x3	0.5 x3
FUA71AVEB9	x2 RZAG140N7V1B				27.9	-	32	-	23.6	0.234	1.4	0.046 x2	0.9 x2	0.9 x2
FAA71BUV1B	x2 RZAG140N7V1B				27.0	-	32	-	23.6	0.234	1.4	0.048 x2	0.5 x2	0.5 x2
FVA71AMVEB	x2 RZAG140N7V1B				27.7	-	32	-	23.6	0.234	1.4	0.117 x2	0.8 x2	0.8 x2
FVA140AMVEB	RZAG140N7V1B				27.9	-	32	-	23.6	0.234	1.4	0.276	1.8	1.8
FDXM35F3V1B	x4 RZAG140N7V1B	27.2	-	32	-	23.6	0.234	1.4	0.034 x4	0.3 x4	0.3 x4			
FDXM50F3V1B	x3 RZAG140N7V1B	28.8	-	32	-	23.6	0.234	1.4	0.060 x3	0.9 x3	0.9 x3			
FHA35AVEB99	x4 RZAG140N7V1B	28.5	-	32	-	23.6	0.234	1.4	0.060 x4	0.6 x4	0.6 x4			
FHA50AVEB99	x3 RZAG140N7V1B	27.9	-	32	-	23.6	0.234	1.4	0.060 x3	0.6 x3	0.6 x3			
FHA71AVEB99	x2 RZAG140N7V1B	27.7	-	32	-	23.6	0.234	1.4	0.091 x2	0.8 x2	0.8 x2			
FHA140AVEB99	RZAG140N7V1B	27.9	-	32	-	23.6	0.234	1.4	0.150	1.8	1.8			

\* Use a separate power supply for the indoor unit. The value between brackets is the MCA of the outdoor unit. For the MCA of the indoor unit, see the installation manual of the indoor unit.

RZAG125-140NV1

3D120943C



**RZAG71-100NY1 COMFORT COOLING**

Indoor	Outdoor	Power supply	Voltage range	MCA	TOCA	MFA	Compressor		OFM		IFM			
							MSC	RLA	kW	FLA	kW	FLA		
FCAHG71HVEB	RZAG71N7Y1B	3N~ 50Hz 380-415V	Minimum: -342 V- Maximum -457 V-	11.1	-	16	-	9.2	0.234	0.8	0.091	0.7		
FCAG35BVEB	x2 RZAG71N7Y1B			11.0	-	16	-	9.2	0.234	0.8	0.044 x2	0.3 x2		
FCAG71BVEB	RZAG71N7Y1B			10.8	-	16	-	9.2	0.234	0.8	0.054	0.4		
FFA35A2VEB	x2 RZAG71N7Y1B			10.8	-	16	-	9.2	0.234	0.8	0.050 x2	0.2 x2		
FBA35A2VEB	x2 RZAG71N7Y1B			(10.4)*	-	16	-	9.2	0.234	0.8	0.089 x2	1.4 x2		
FBA71A2VEB	RZAG71N7Y1B			(10.4)*	-	16	-	9.2	0.234	0.8	0.070	1.3		
FNA35A2VEB	x2 RZAG71N7Y1B			11.4	-	16	-	9.2	0.234	0.8	0.034 x2	0.5 x2		
FUA71AVEB9	RZAG71N7Y1B			11.3	-	16	-	9.2	0.234	0.8	0.046	0.9		
FAA71BUV1B	RZAG71N7Y1B			10.9	-	16	-	9.2	0.234	0.8	0.048	0.5		
FVA71AMVEB	RZAG71N7Y1B			11.2	-	16	-	9.2	0.234	0.8	0.117	0.8		
FDXM35F3V1B	x2 RZAG71N7Y1B			11.0	-	16	-	9.2	0.234	0.8	0.034 x2	0.3 x2		
FHA35AVEB99	x2 RZAG71N7Y1B			11.6	-	16	-	9.2	0.234	0.8	0.060 x2	0.6 x2		
FHA71AVEB99	RZAG71N7Y1B			11.2	-	16	-	9.2	0.234	0.8	0.091	0.8		
FCAHG100HVEB	RZAG100N7Y1B			3N~ 50Hz 380-415V	Minimum: -342 V- Maximum -457 V-	14.9	-	16	-	11.8	0.234	1.2	0.221	1.3
FCAG35BVEB	x3 RZAG100N7Y1B					13.0	-	16	-	10.4	0.234	1.2	0.044 x3	0.3 x3
FCAG50BVEB	x2 RZAG100N7Y1B					12.7	-	16	-	10.4	0.234	1.2	0.039 x2	0.3 x2
FCAG100BVEB	RZAG100N7Y1B					14.2	-	16	-	11.8	0.234	1.2	0.117	0.7
FFA35A2VEB	x3 RZAG100N7Y1B					12.7	-	16	-	10.4	0.234	1.2	0.050 x3	0.2 x3
FFA50A2VEB	x2 RZAG100N7Y1B					12.9	-	16	-	10.4	0.234	1.2	0.050 x2	0.4 x2
FBA35A2VEB	x3 RZAG100N7Y1B					(12.1)*	-	16	-	10.4	0.234	1.2	0.089 x3	1.4 x3
FBA50A2VEB	x2 RZAG100N7Y1B	(12.1)*	-			16	-	10.4	0.234	1.2	0.089 x2	1.4 x2		
FBA100A2VEB	RZAG100N7Y1B	(13.5)*	-			16	-	11.8	0.234	1.2	0.127	3.5		
FNA35A2VEB	x3 RZAG100N7Y1B	13.6	-			16	-	10.4	0.234	1.2	0.034 x3	0.5 x3		
FNA50A2VEB	x2 RZAG100N7Y1B	13.1	-			16	-	10.4	0.234	1.2	0.060 x2	0.5 x2		
FUA100AVEB9	RZAG100N7Y1B	14.9	-			16	-	11.8	0.234	1.2	0.106	1.3		
FAA100BUV1B	RZAG100N7Y1B	14.4	-			16	-	11.8	0.234	1.2	0.064	0.9		
FVA100AMVEB	RZAG100N7Y1B	15.1	-			16	-	11.8	0.234	1.2	0.238	1.5		
FDXM35F3V1B	x3 RZAG100N7Y1B	13.0	-			16	-	10.4	0.234	1.2	0.034 x3	0.3 x3		
FDXM50F3V1B	x2 RZAG100N7Y1B	13.9	-			16	-	10.4	0.234	1.2	0.060 x2	0.9 x2		
FHA35AVEB99	x3 RZAG100N7Y1B	13.9	-			16	-	10.4	0.234	1.2	0.060 x3	0.6 x3		
FHA50AVEB99	x2 RZAG100N7Y1B	13.3	-			16	-	10.4	0.234	1.2	0.060 x2	0.6 x2		
FHA100AVEB9	RZAG100N7Y1B	14.9	-			16	-	11.8	0.234	1.2	0.150	1.3		

\* Use a separate power supply for the indoor unit. The value between brackets is the MCA of the outdoor unit. For the MCA of the indoor unit, see the installation manual of the indoor unit.

RZAG71-100NY1

**3D120943C**

**RZAG125-140NY1 COMFORT COOLING**

Indoor	Outdoor	Power supply	Voltage range	MCA	TOCA	MFA	Compressor		OFM		IFM	
							MSC	RLA	kW	FLA	kW	FLA
FCAHG125HVEB	RZAG125N7Y1B	3N~ 50Hz 380-415V	Minimum: -342 V- Maximum -457 V-	15.0	-	16	-	11.8	0.234	1.2	0.244	1.4
FCAG35BVEB	x4 RZAG125N7Y1B			12.2	-	16	-	9.3	0.234	1.2	0.044 x4	0.3 x4
FCAG50BVEB	x3 RZAG125N7Y1B			12.9	-	16	-	10.3	0.234	1.2	0.039 x3	0.3 x3
FCAG60BVEB	x2 RZAG125N7Y1B			14.1	-	16	-	11.8	0.234	1.2	0.044 x2	0.3 x2
FCAG125BVEB	RZAG125N7Y1B			14.6	-	16	-	11.8	0.234	1.2	0.168	1.0
FFA35A2VEB	x4 RZAG125N7Y1B			11.8	-	16	-	9.3	0.234	1.2	0.050 x4	0.2 x4
FFA50A2VEB	x3 RZAG125N7Y1B			13.2	-	16	-	10.3	0.234	1.2	0.050 x3	0.4 x3
FFA60A2VEB	x2 RZAG125N7Y1B			14.8	-	16	-	11.8	0.234	1.2	0.050 x2	0.6 x2
FBA35A2VEB	x4 RZAG125N7Y1B			(10.9)*	-	16	-	9.3	0.234	1.2	0.089 x4	1.4 x4
FBA50A2VEB	x3 RZAG125N7Y1B			(12.0)*	-	16	-	10.3	0.234	1.2	0.089 x3	1.4 x3
FBA60A2VEB	x2 RZAG125N7Y1B			(13.5)*	-	16	-	11.8	0.234	1.2	0.070 x2	1.3 x2
FBA125A2VEB	RZAG125N7Y1B			(13.5)*	-	16	-	11.8	0.234	1.2	0.187	3.9
FNA35A2VEB	x4 RZAG125N7Y1B			13.0	-	16	-	9.3	0.234	1.2	0.034 x4	0.5 x4
FNA50A2VEB	x3 RZAG125N7Y1B			13.5	-	16	-	10.3	0.234	1.2	0.060 x3	0.5 x3
FNA60A2VEB	x2 RZAG125N7Y1B			14.8	-	16	-	11.8	0.234	1.2	0.060 x2	0.6 x2
FUA125AVEB9	RZAG125N7Y1B			15.0	-	16	-	11.8	0.234	1.2	0.106	1.4
FDA125AVEB	RZAG125N7Y1B			15.7	-	16	-	11.8	0.234	1.2	0.350	2.1
FVA125AMVEB	RZAG125N7Y1B			15.1	-	16	-	11.8	0.234	1.2	0.238	1.5
FDXM35F3V1B	x4 RZAG125N7Y1B			12.2	-	16	-	9.3	0.234	1.2	0.034 x4	0.3 x4
FDXM50F3V1B	x3 RZAG125N7Y1B			14.8	-	16	-	10.3	0.234	1.2	0.060 x3	0.9 x3
FDXM60F3V1B	x2 RZAG125N7Y1B	15.4	-	16	-	11.8	0.234	1.2	0.060 x2	0.9 x2		
FHA35AVEB99	x4 RZAG125N7Y1B	13.4	-	16	-	9.3	0.234	1.2	0.060 x4	0.6 x4		
FHA50AVEB99	x3 RZAG125N7Y1B	13.8	-	16	-	10.3	0.234	1.2	0.060 x3	0.6 x3		
FHA60AVEB99	x2 RZAG125N7Y1B	14.8	-	16	-	11.8	0.234	1.2	0.091 x2	0.6 x2		
FHA125AVEB9	RZAG125N7Y1B	15.1	-	16	-	11.8	0.234	1.2	0.150	1.5		
FCAHG71HVEB	x2 RZAG140N7Y1B	3N~ 50Hz 380-415V	Minimum: -342 V- Maximum -457 V-	15.0	-	16	-	11.6	0.234	1.4	0.091 x2	0.7 x2
FCAHG140HVEB	RZAG140N7Y1B			15.0	-	16	-	11.6	0.234	1.4	0.244	1.4
FCAG35BVEB	x4 RZAG140N7Y1B			12.2	-	16	-	9.1	0.234	1.4	0.044 x4	0.3 x4
FCAG50BVEB	x3 RZAG140N7Y1B			12.9	-	16	-	10.1	0.234	1.4	0.039 x3	0.3 x3
FCAG71BVEB	x2 RZAG140N7Y1B			14.4	-	16	-	11.6	0.234	1.4	0.054 x2	0.4 x2
FCAG140BVEB	RZAG140N7Y1B			14.9	-	16	-	11.6	0.234	1.4	0.168	1.3
FFA35A2VEB	x4 RZAG140N7Y1B			11.8	-	16	-	9.1	0.234	1.4	0.050 x4	0.2 x4
FFA50A2VEB	x3 RZAG140N7Y1B			13.2	-	16	-	10.1	0.234	1.4	0.050 x3	0.4 x3
FBA35A2VEB	x4 RZAG140N7Y1B			(10.9)*	-	16	-	9.1	0.234	1.4	0.089 x4	1.4 x4
FBA50A2VEB	x3 RZAG140N7Y1B			(12.0)*	-	16	-	10.1	0.234	1.4	0.089 x3	1.4 x3
FBA71A2VEB	x2 RZAG140N7Y1B			(13.5)*	-	16	-	11.6	0.234	1.4	0.070 x2	1.3 x2
FBA140A2VEB	RZAG140N7Y1B			(13.5)*	-	16	-	11.6	0.234	1.4	0.187	3.9
FNA35A2VEB	x4 RZAG140N7Y1B			13.0	-	16	-	9.1	0.234	1.4	0.034 x4	0.5 x4
FNA50A2VEB	x3 RZAG140N7Y1B			13.5	-	16	-	10.1	0.234	1.4	0.060 x3	0.5 x3
FUA71AVEB9	x2 RZAG140N7Y1B			15.4	-	16	-	11.6	0.234	1.4	0.046 x2	0.9 x2
FAA71BUV1B	x2 RZAG140N7Y1B			14.6	-	16	-	11.6	0.234	1.4	0.048 x2	0.5 x2
FVA71AMVEB	x2 RZAG140N7Y1B			15.2	-	16	-	11.6	0.234	1.4	0.117 x2	0.8 x2
FVA140AMVEB	RZAG140N7Y1B			15.4	-	16	-	11.6	0.234	1.4	0.276	1.8
FDXM35F3V1B	x4 RZAG140N7Y1B			12.2	-	16	-	9.1	0.234	1.4	0.034 x4	0.3 x4
FDXM50F3V1B	x3 RZAG140N7Y1B			14.8	-	16	-	10.1	0.234	1.4	0.060 x3	0.9 x3
FHA35AVEB99	x4 RZAG140N7Y1B	13.4	-	16	-	9.1	0.234	1.4	0.060 x4	0.6 x4		
FHA50AVEB99	x3 RZAG140N7Y1B	13.8	-	16	-	10.1	0.234	1.4	0.060 x3	0.6 x3		
FHA71AVEB99	x2 RZAG140N7Y1B	15.2	-	16	-	11.6	0.234	1.4	0.091 x2	0.8 x2		
FHA140AVEB99	RZAG140N7Y1B	15.4	-	16	-	11.6	0.234	1.4	0.150	1.8		

\* Use a separate power supply for the indoor unit. The value between brackets is the MCA of the outdoor unit. For the MCA of the indoor unit, see the installation manual of the indoor unit.

RZAG125-140NY1

**3D120943C**



## RZAG-NV1/NY1

Symbols	Notes
<p>MCA Minimum Circuit Ampere [A]            TOCA Total overcurrent amps [A]            MFA Maximum Fuse Ampere [A]            MSC Maximum current of the starting compressor [A]            RLA Rated load amps [A]            OFM Outdoor fan motor            IFM Indoor fan motor            FLA Full Load Ampere [A]            kW Fan motor rated output [kW]</p>	<p>1 The -RLA- is based on the following conditions.            Cooling            Indoor temperature -27.0°C DB / -19.0°C WB            Outdoor temperature -35.0°C DB            Heating            Indoor temperature -20.0°C DB            Outdoor temperature -7.0°C DB / -6.0°C WB            2 -TOCA- is the total value of each overcurrent set.            3 Voltage range            4 The maximum allowable voltage that is unbalanced between phases is -2%.            5 -MCA- is the maximum input current.            The capacity of the -MFA- must be greater than that of the -MCA-.            Select the -MFA- according to the table.            6 Select the wire size according to the MCA.            7 -MFA- is used to select the circuit breaker and the ground fault circuit interruptor.            Earth leakage circuit breaker</p>

**3D120943C**

## RZAG71-100NV1 INFRASTRUCTURE COOLING

Indoor	Outdoor	Power supply	Voltage range	Compressor		OFM		IFM						
				MCA	TOCA	MFA	MSC	RLA	kW	FLA	kW	FLA		
FCAHG100HVEB	RZAG71N7V1B	50Hz ~ 220-240V	Minimum: -198 V- Maximum -264 V-	18.3	-	20	-	15.5	0.234	0.8	0.221	1.3		
FCAG35BVEB	x3 RZAG71N7V1B			17.9	-	20	-	15.5	0.234	0.8	0.044 x3	0.3 x3		
FCAG50BVEB	x2 RZAG71N7V1B			17.6	-	20	-	15.5	0.234	0.8	0.039 x2	0.3 x2		
FCAG100BVEB	RZAG71N7V1B			17.7	-	20	-	15.5	0.234	0.8	0.117	0.7		
FFA35A2VEB	x3 RZAG71N7V1B			17.6	-	20	-	15.5	0.234	0.8	0.050 x3	0.2 x3		
FFA50A2VEB	x2 RZAG71N7V1B			17.8	-	20	-	15.5	0.234	0.8	0.050 x2	0.4 x2		
FBA35A2VEB	x3 RZAG71N7V1B			21.3	-	20	-	15.5	0.234	0.8	0.089 x3	1.4 x3		
FBA50A2VEB	x2 RZAG71N7V1B			19.9	-	20	-	15.5	0.234	0.8	0.089 x2	1.4 x2		
FBA100A2VEB	RZAG71N7V1B			20.6	-	20	-	15.5	0.234	0.8	0.127	3.5		
FUA100AVEB9	RZAG71N7V1B			18.3	-	20	-	15.5	0.234	0.8	0.106	1.3		
FAA100BUV1B	RZAG71N7V1B			17.9	-	20	-	15.5	0.234	0.8	0.064	0.5		
FVA100AMVEB	RZAG71N7V1B			18.5	-	20	-	15.5	0.234	0.8	0.238	1.5		
FDXM35F3V1B	x3 RZAG71N7V1B			17.9	-	20	-	15.5	0.234	0.8	0.034 x3	0.3 x3		
FDXM50F3V1B	x2 RZAG71N7V1B			18.8	-	20	-	15.5	0.234	0.8	0.060 x2	0.9 x2		
FHA35AVEB99	x3 RZAG71N7V1B			18.8	-	20	-	15.5	0.234	0.8	0.060 x3	0.6 x3		
FHA50AVEB99	x2 RZAG71N7V1B			18.2	-	20	-	15.5	0.234	0.8	0.060 x2	0.6 x2		
FHA100AVEB99	RZAG71N7V1B			18.3	-	20	-	15.5	0.234	0.8	0.150	1.3		
FCAHG71HVEB	x2 RZAG100N7V1B			50Hz ~ 220-240V	Minimum: -198 V- Maximum -264 V-	22.3	-	32	-	18.8	0.234	1.2	0.091 x2	0.7 x2
FCAHG140HVEB	RZAG100N7V1B					22.3	-	32	-	18.8	0.234	1.2	0.244	1.4
FCAG35BVEB	x4 RZAG100N7V1B					22.0	-	32	-	18.8	0.234	1.2	0.044 x4	0.3 x4
FCAG50BVEB	x3 RZAG100N7V1B	21.7	-			32	-	18.8	0.234	1.2	0.039 x3	0.3 x3		
FCAG71BVEB	x2 RZAG100N7V1B	21.6	-			32	-	18.8	0.234	1.2	0.054 x2	0.4 x2		
FCAG140BVEB	RZAG100N7V1B	22.2	-			32	-	18.8	0.234	1.2	0.168	1.3		
FFA35A2VEB	x4 RZAG100N7V1B	21.6	-			32	-	18.8	0.234	1.2	0.050 x4	0.8		
FFA50A2VEB	x3 RZAG100N7V1B	22.0	-			32	-	18.8	0.234	1.2	0.050 x3	0.4 x3		
FBA35A2VEB	x4 RZAG100N7V1B	26.6	-			32	-	18.8	0.234	1.2	0.089 x4	1.4 x4		
FBA50A2VEB	x3 RZAG100N7V1B	25.2	-			32	-	18.8	0.234	1.2	0.089 x3	1.4 x3		
FBA71A2VEB	x2 RZAG100N7V1B	23.5	-			32	-	18.8	0.234	1.2	0.07 x2	1.3 x2		
FBA140A2VEB	RZAG100N7V1B	24.9	-			32	-	18.8	0.234	1.2	0.187	3.9		
FUA71AVEB9	x2 RZAG100N7V1B	22.7	-			32	-	18.8	0.234	1.2	0.046 x2	0.9 x2		
FAA71BUV1B	x2 RZAG100N7V1B	21.8	-			32	-	18.8	0.234	1.2	0.048 x2	0.5 x2		
FVA140AMVEB	RZAG100N7V1B	22.7	-			32	-	18.8	0.234	1.2	0.276	1.8		
FDXM35F3V1B	x4 RZAG100N7V1B	22.0	-			32	-	18.8	0.234	1.2	0.034 x4	0.3 x4		
FDXM50F3V1B	x3 RZAG100N7V1B	23.6	-			32	-	18.8	0.234	1.2	0.060 x3	0.9 x3		
FHA35AVEB99	x4 RZAG100N7V1B	23.3	-			32	-	18.8	0.234	1.2	0.060 x4	0.6 x4		
FHA50AVEB99	x3 RZAG100N7V1B	22.7	-			32	-	18.8	0.234	1.2	0.060 x3	0.6 x3		
FHA71AVEB99	x2 RZAG100N7V1B	22.5	-			32	-	18.8	0.234	1.2	0.091 x2	0.8 x2		
FHA140AVEB99	RZAG100N7V1B	22.7	-	32	-	18.8	0.234	1.2	0.150	1.8				

\* Use a separate power supply for the indoor unit. The value between brackets is the MCA of the outdoor unit. For the MCA of the indoor unit, see the installation manual of the indoor unit.

RZAG71-100NV1

**3D120944D**

### RZAG125-140NV1 INFRASTRUCTURE COOLING

Indoor	Outdoor	Power supply	Voltage range	Compressor					OFM		IFM					
				MCA	TOCA	MFA	MSC	RLA	kW	FLA	kW	FLA				
FCAHG71HVEB	x2 RZAG125N7V1B	50Hz ~ 220-240V	Minimum: ·198 V·	Maximum ·264 V·	27.5	-	32	-	23.8	0.234	1.2	0.091 x2	0.7 x2			
FCAHG140HVEB	RZAG125N7V1B				27.5	-	32	-	23.8	0.234	1.2	0.244	1.4			
FCAG35BVEB	x4 RZAG125N7V1B				27.2	-	32	-	23.8	0.234	1.2	0.044 x4	0.3 x4			
FCAG50BVEB	x3 RZAG125N7V1B				26.9	-	32	-	23.8	0.234	1.2	0.039 x3	0.3 x3			
FCAG71BVEB	x2 RZAG125N7V1B				26.8	-	32	-	23.8	0.234	1.2	0.054 x2	0.4 x2			
FCAG140BVEB	RZAG125N7V1B				27.4	-	32	-	23.8	0.234	1.2	0.168	1.3			
FFA35A2VEB	x4 RZAG125N7V1B				26.8	-	32	-	23.8	0.234	1.2	0.050 x4	0.2 x4			
FFA50A2VEB	x3 RZAG125N7V1B				27.2	-	32	-	23.8	0.234	1.2	0.050 x3	0.4 x3			
FBA35A2VEB	x4 RZAG125N7V1B				31.8	-	32	-	23.8	0.234	1.2	0.089 x4	1.4 x4			
FBA50A2VEB	x3 RZAG125N7V1B				30.4	-	32	-	23.8	0.234	1.2	0.089 x3	1.4 x3			
FBA71A2VEB	x2 RZAG125N7V1B				28.7	-	32	-	23.8	0.234	1.2	0.07 x2	1.3 x2			
FBA140A2VEB	RZAG125N7V1B				30.1	-	32	-	23.8	0.234	1.2	0.187	3.9			
FUA71AVEB9	x2 RZAG125N7V1B				27.9	-	32	-	23.8	0.234	1.2	0.046 x2	0.9 x2			
FAA71BUV1B	x2 RZAG125N7V1B				27.0	-	32	-	23.8	0.234	1.2	0.048 x2	0.5 x2			
FVA140AMVEB	RZAG125N7V1B				27.9	-	32	-	23.8	0.234	1.2	0.276	1.8			
FDXM35F3V1B	x4 RZAG125N7V1B				27.2	-	32	-	23.8	0.234	1.2	0.034 x4	0.3 x4			
FDXM50F3V1B	x3 RZAG125N7V1B				28.8	-	32	-	23.8	0.234	1.2	0.060 x3	0.9 x3			
FHA35AVEB99	x4 RZAG125N7V1B				28.5	-	32	-	23.8	0.234	1.2	0.060 x4	0.6 x4			
FHA50AVEB99	x3 RZAG125N7V1B				27.9	-	32	-	23.8	0.234	1.2	0.060 x3	0.6 x3			
FHA71AVEB99	x2 RZAG125N7V1B				27.7	-	32	-	23.8	0.234	1.2	0.091 x2	0.8 x2			
FHA140AVEB99	RZAG125N7V1B				27.9	-	32	-	23.8	0.234	1.2	0.15	1.8			
FCAHG71HVEB	x2 RZAG140N7V1B				50Hz ~ 220-240V	Minimum: ·198 V·	Maximum ·264 V·	27.5	-	32	-	23.6	0.234	1.4	0.091 x2	0.7 x2
FCAHG140HVEB	RZAG140N7V1B							27.5	-	32	-	23.6	0.234	1.4	0.244	1.4
FCAG35BVEB	x4 RZAG140N7V1B							27.2	-	32	-	23.6	0.234	1.4	0.044 x4	0.3 x4
FCAG50BVEB	x3 RZAG140N7V1B							26.9	-	32	-	23.6	0.234	1.4	0.039 x3	0.3 x3
FCAG71BVEB	x2 RZAG140N7V1B							26.8	-	32	-	23.6	0.234	1.4	0.054 x2	0.4 x2
FCAG140BVEB	RZAG140N7V1B							27.4	-	32	-	23.6	0.234	1.4	0.168	1.3
FFA35A2VEB	x4 RZAG140N7V1B							26.8	-	32	-	23.6	0.234	1.4	0.050 x4	0.2 x4
FFA50A2VEB	x3 RZAG140N7V1B	27.2	-	32				-	23.6	0.234	1.4	0.050 x3	0.4 x3			
FBA35A2VEB	x4 RZAG140N7V1B	31.8	-	32				-	23.6	0.234	1.4	0.089 x4	1.4 x4			
FBA50A2VEB	x3 RZAG140N7V1B	30.4	-	32				-	23.6	0.234	1.4	0.089 x3	1.4 x3			
FBA71A2VEB	x2 RZAG140N7V1B	28.7	-	32				-	23.6	0.234	1.4	0.070 x2	1.3 x2			
FBA140A2VEB	RZAG140N7V1B	30.1	-	32				-	23.6	0.234	1.4	0.187	3.9			
FUA71AVEB9	x2 RZAG140N7V1B	27.9	-	32				-	23.6	0.234	1.4	0.046 x2	0.9 x2			
FAA71BUV1B	x2 RZAG140N7V1B	27.0	-	32				-	23.6	0.234	1.4	0.048 x2	0.5 x2			
FVA140AMVEB	RZAG140N7V1B	27.9	-	32				-	23.6	0.234	1.4	0.276	1.8			
FDXM35F3V1B	x4 RZAG140N7V1B	27.2	-	32				-	23.6	0.234	1.4	0.034 x4	0.3 x4			
FDXM50F3V1B	x3 RZAG140N7V1B	28.8	-	32				-	23.6	0.234	1.4	0.060 x3	0.9 x3			
FHA35AVEB99	x4 RZAG140N7V1B	28.5	-	32				-	23.6	0.234	1.4	0.060 x4	0.6 x4			
FHA50AVEB99	x3 RZAG140N7V1B	27.9	-	32				-	23.6	0.234	1.4	0.060 x3	0.6 x3			
FHA71AVEB99	x2 RZAG140N7V1B	27.7	-	32				-	23.6	0.234	1.4	0.091 x2	0.8 x2			
FHA140AVEB99	RZAG140N7V1B	27.9	-	32				-	23.6	0.234	1.4	0.150	1.8			

\* Use a separate power supply for the indoor unit. The value between brackets is the MCA of the outdoor unit. For the MCA of the indoor unit, see the installation manual of the indoor unit.

RZAG125-140NV1

**3D120944D**

### RZAG71-100NY1 INFRASTRUCTURE COOLING

Indoor	Outdoor	Power supply	Voltage range	Compressor					OFM		IFM					
				MCA	TOCA	MFA	MSC	RLA	kW	FLA	kW	FLA				
FCAHG100HVEB	RZAG71N7Y1B	3N~ 50Hz 380-415V	Minimum: ·342 V·	Maximum ·457 V·	11.8	-	16	-	9.2	0.234	0.8	0.221	1.3			
FCAG35BVEB	x3 RZAG71N7Y1B				11.3	-	16	-	9.2	0.234	0.8	0.044 x3	0.3 x3			
FCAG50BVEB	x2 RZAG71N7Y1B				11.0	-	16	-	9.2	0.234	0.8	0.039 x2	0.3 x2			
FCAG100BVEB	RZAG71N7Y1B				11.1	-	16	-	9.2	0.234	0.8	0.117	0.7			
FFA35A2VEB	x3 RZAG71N7Y1B				11.0	-	16	-	9.2	0.234	0.8	0.050 x3	0.2 x3			
FFA50A2VEB	x2 RZAG71N7Y1B				11.2	-	16	-	9.2	0.234	0.8	0.050 x2	0.4 x2			
FBA35A2VEB	x3 RZAG71N7Y1B				(10.4)*	-	16	-	9.2	0.234	0.8	0.089 x3	1.4 x3			
FBA50A2VEB	x2 RZAG71N7Y1B				(10.4)*	-	16	-	9.2	0.234	0.8	0.089 x2	1.4 x2			
FBA100A2VEB	RZAG71N7Y1B				(10.4)*	-	16	-	9.2	0.234	0.8	0.127	3.5			
FUA100AVEB9	RZAG71N7Y1B				11.8	-	16	-	9.2	0.234	0.8	0.106	1.3			
FAA100BUV1B	RZAG71N7Y1B				11.3	-	16	-	9.2	0.234	0.8	0.064	0.5			
FVA100AMVEB	RZAG71N7Y1B				12.0	-	16	-	9.2	0.234	0.8	0.238	1.5			
FDXM35F3V1B	x3 RZAG71N7Y1B				11.3	-	16	-	9.2	0.234	0.8	0.034 x3	0.3 x3			
FDXM50F3V1B	x2 RZAG71N7Y1B				12.3	-	16	-	9.2	0.234	0.8	0.060 x2	0.9 x2			
FHA35AVEB99	x3 RZAG71N7Y1B				12.3	-	16	-	9.2	0.234	0.8	0.060 x3	0.6 x3			
FHA50AVEB99	x2 RZAG71N7Y1B				11.6	-	16	-	9.2	0.234	0.8	0.060 x2	0.6 x2			
FHA100AVEB99	RZAG71N7Y1B				11.8	-	16	-	9.2	0.234	0.8	0.15	1.3			
FCAHG71HVEB	x2 RZAG100N7Y1B				3N~ 50Hz 380-415V	Minimum: ·342 V·	Maximum ·457 V·	13.5	-	16	-	10.4	0.234	1.2	0.091 x2	0.7 x2
FCAHG140HVEB	RZAG100N7Y1B							15.0	-	16	-	11.8	0.234	1.2	0.244	1.4
FCAG35BVEB	x4 RZAG100N7Y1B							13.3	-	16	-	10.4	0.234	1.2	0.044 x4	0.3 x4
FCAG50BVEB	x3 RZAG100N7Y1B							13.0	-	16	-	10.4	0.234	1.2	0.039 x3	0.3 x3
FCAG71BVEB	x2 RZAG100N7Y1B							12.9	-	16	-	10.4	0.234	1.2	0.054 x2	0.4 x2
FCAG140BVEB	RZAG100N7Y1B							14.9	-	16	-	11.8	0.234	1.2	0.168	1.3
FFA35A2VEB	x4 RZAG100N7Y1B							12.9	-	16	-	10.4	0.234	1.2	0.050 x4	0.8
FFA50A2VEB	x3 RZAG100N7Y1B							13.3	-	16	-	10.4	0.234	1.2	0.050 x3	0.4 x3
FBA35A2VEB	x4 RZAG100N7Y1B							(12.1)*	-	16	-	10.4	0.234	1.2	0.089 x4	1.4 x4
FBA50A2VEB	x3 RZAG100N7Y1B							(12.1)*	-	16	-	10.4	0.234	1.2	0.089 x3	1.4 x3
FBA71A2VEB	x2 RZAG100N7Y1B							(12.1)*	-	16	-	10.4	0.234	1.2	0.07 x2	1.3 x2
FBA140A2VEB	RZAG100N7Y1B	(13.5)*	-	16				-	11.8	0.234	1.2	0.187	3.9			
FUA71AVEB9	x2 RZAG100N7Y1B	13.9	-	16				-	10.4	0.234	1.2	0.046 x2	0.9 x2			
FAA71BUV1B	x2 RZAG100N7Y1B	13.1	-	16				-	10.4	0.234	1.2	0.048 x2	0.5 x2			
FVA140AMVEB	RZAG100N7Y1B	15.4	-	16				-	11.8	0.234	1.2	0.276	1.8			
FDXM35F3V1B	x4 RZAG100N7Y1B	13.3	-	16				-	10.4	0.234	1.2	0.034 x4	0.3 x4			
FDXM50F3V1B	x3 RZAG100N7Y1B	14.9	-	16				-	10.4	0.234	1.2	0.060 x3	0.9 x3			
FHA35AVEB99	x4 RZAG100N7Y1B	14.6	-	16				-	10.4	0.234	1.2	0.060 x4	0.6 x4			
FHA50AVEB99	x3 RZAG100N7Y1B	13.9	-	16				-	10.4	0.234	1.2	0.060 x3	0.6 x3			
FHA71AVEB99	x2 RZAG100N7Y1B	13.7	-	16				-	10.4	0.234	1.2	0.091 x2	0.8 x2			
FHA140AVEB99	RZAG100N7Y1B	15.4	-	16				-	11.8	0.234	1.2	0.15	1.8			

\* Use a separate power supply for the indoor unit. The value between brackets is the MCA of the outdoor unit. For the MCA of the indoor unit, see the installation manual of the indoor unit.

RZAG71-100NY1

**3D120944D**



## RZAG125-140NY1 INFRASTRUCTURE COOLING

Indoor	Outdoor	Power supply	Voltage range	MCA	TOCA	MFA	Compressor		OFM		IFM			
							MSC	RLA	kW	FLA	kW	FLA		
FCAHG11HVEB	x2 RZAG125N7Y1B	3N~ 50Hz 380-415V	Minimum: -342 V· Maximum -457 V·	15.0	-	16	-	11.8	0.234	1.2	0.091 x2	0.7 x2		
FCAHG140HVEB	RZAG125N7Y1B			15.0	-	16	-	11.8	0.234	1.2	0.244	1.4		
FCAG35BVEB	x4 RZAG125N7Y1B			12.2	-	16	-	9.3	0.234	1.2	0.044 x4	0.3 x4		
FCAG50BVEB	x3 RZAG125N7Y1B			12.9	-	16	-	10.3	0.234	1.2	0.039 x3	0.3 x3		
FCAG71BVEB	x2 RZAG125N7Y1B			14.4	-	16	-	11.8	0.234	1.2	0.054 x2	0.4 x2		
FCAG140BVEB	RZAG125N7Y1B			14.9	-	16	-	11.8	0.234	1.2	0.168	1.3		
FFA35A2VEB	x4 RZAG125N7Y1B			11.8	-	16	-	9.3	0.234	1.2	0.050 x4	0.2 x4		
FFA50A2VEB	x3 RZAG125N7Y1B			13.2	-	16	-	10.3	0.234	1.2	0.050 x3	0.4 x3		
FBA35A2VEB	x4 RZAG125N7Y1B			(10.9)*	-	16	-	9.3	0.234	1.2	0.089 x4	1.4 x4		
FBA50A2VEB	x3 RZAG125N7Y1B			(12.0)*	-	16	-	10.3	0.234	1.2	0.089 x3	1.4 x3		
FBA71A2VEB	x2 RZAG125N7Y1B			(13.5)*	-	16	-	11.8	0.234	1.2	0.070 x2	1.3 x2		
FBA140A2VEB	RZAG125N7Y1B			(13.5)*	-	16	-	11.8	0.234	1.2	0.187	3.9		
FUA71AVEB9	x2 RZAG125N7Y1B			15.4	-	16	-	11.8	0.234	1.2	0.046 x2	0.9 x2		
FAA71BUV1B	x2 RZAG125N7Y1B			14.6	-	16	-	11.8	0.234	1.2	0.048 x2	0.5 x2		
FVA140AMVEB	RZAG125N7Y1B			15.4	-	16	-	11.8	0.234	1.2	0.276	1.8		
FDXM35F3V1B	x4 RZAG125N7Y1B			12.2	-	16	-	9.3	0.234	1.2	0.034 x4	0.3 x4		
FDXM50F3V1B	x3 RZAG125N7Y1B			14.8	-	16	-	10.3	0.234	1.2	0.060 x3	0.9 x3		
FHA35AVEB99	x4 RZAG125N7Y1B			13.4	-	16	-	9.3	0.234	1.2	0.060 x4	0.6 x4		
FHA50AVEB99	x3 RZAG125N7Y1B			13.8	-	16	-	10.3	0.234	1.2	0.060 x3	0.6 x3		
FHA71AVEB99	x2 RZAG125N7Y1B			15.2	-	16	-	11.8	0.234	1.2	0.091 x2	0.8 x2		
FHA140AVEB99	RZAG125N7Y1B			15.4	-	16	-	11.8	0.234	1.2	0.150	1.8		
FCAHG11HVEB	x2 RZAG140N7Y1B			3N~ 50Hz 380-415V	Minimum: -342 V· Maximum -457 V·	15.0	-	16	-	11.6	0.234	1.4	0.091 x2	0.7 x2
FCAHG140HVEB	RZAG140N7Y1B					15.0	-	16	-	11.6	0.234	1.4	0.244	1.4
FCAG35BVEB	x4 RZAG140N7Y1B					12.2	-	16	-	9.1	0.234	1.4	0.044 x4	0.3 x4
FCAG50BVEB	x3 RZAG140N7Y1B					12.9	-	16	-	10.1	0.234	1.4	0.039 x3	0.3 x3
FCAG71BVEB	x2 RZAG140N7Y1B					14.4	-	16	-	11.6	0.234	1.4	0.054 x2	0.4 x2
FCAG140BVEB	RZAG140N7Y1B					14.9	-	16	-	11.6	0.234	1.4	0.168	1.3
FFA35A2VEB	x4 RZAG140N7Y1B					11.8	-	16	-	9.1	0.234	1.4	0.050 x4	0.2 x4
FFA50A2VEB	x3 RZAG140N7Y1B	13.2	-			16	-	10.1	0.234	1.4	0.050 x3	0.4 x3		
FBA35A2VEB	x4 RZAG140N7Y1B	(10.9)*	-			16	-	9.1	0.234	1.4	0.089 x4	1.4 x4		
FBA50A2VEB	x3 RZAG140N7Y1B	(12.0)*	-			16	-	10.1	0.234	1.4	0.089 x3	1.4 x3		
FBA71A2VEB	x2 RZAG140N7Y1B	(13.5)*	-			16	-	11.6	0.234	1.4	0.070 x2	1.3 x2		
FBA140A2VEB	RZAG140N7Y1B	(13.5)*	-			16	-	11.6	0.234	1.4	0.187	3.9		
FUA71AVEB9	x2 RZAG140N7Y1B	15.4	-			16	-	11.6	0.234	1.4	0.046 x2	0.9 x2		
FAA71BUV1B	x2 RZAG140N7Y1B	14.6	-			16	-	11.6	0.234	1.4	0.048 x2	0.5 x2		
FVA140AMVEB	RZAG140N7Y1B	15.4	-			16	-	11.6	0.234	1.4	0.276	1.8		
FDXM35F3V1B	x4 RZAG140N7Y1B	12.2	-			16	-	9.1	0.234	1.4	0.034 x4	0.3 x4		
FDXM50F3V1B	x3 RZAG140N7Y1B	14.8	-			16	-	10.1	0.234	1.4	0.060 x3	0.9 x3		
FHA35AVEB99	x4 RZAG140N7Y1B	13.4	-			16	-	9.1	0.234	1.4	0.060 x4	0.6 x4		
FHA50AVEB99	x3 RZAG140N7Y1B	13.8	-			16	-	10.1	0.234	1.4	0.060 x3	0.6 x3		
FHA71AVEB99	x2 RZAG140N7Y1B	15.2	-			16	-	11.6	0.234	1.4	0.091 x2	0.8 x2		
FHA140AVEB99	RZAG140N7Y1B	15.4	-			16	-	11.6	0.234	1.4	0.150	1.8		

\* Use a separate power supply for the indoor unit. The value between brackets is the MCA of the indoor unit. For the actual MCA value, see the installation manual of the indoor unit.

RZAG125-140NY1

**3D120944D**

## RZAG-NV1/NY1

Symbols	Notes
MCA Minimum Circuit Ampere [A]	<p>1 The -RLA- is based on the following conditions. Cooling Indoor temperature -27.0°C DB / -19.0°C WB Outdoor temperature -35.0°C DB Heating Indoor temperature -20.0°C DB Outdoor temperature -7.0°C DB / -6.0°C WB</p> <p>2 -TOCA- is the total value of each overcurrent set.</p> <p>3 Voltage range The units are suitable for use with electrical systems in which the voltage supplied to the unit terminals is not below or above the listed range limits.</p> <p>4 The maximum allowable voltage that is unbalanced between phases is -2%.</p> <p>5 -MCA- is the maximum input current. The capacity of the -MFA- must be greater than that of the -MCA-.</p> <p>6 Select the wire size according to the MCA.</p> <p>7 -MFA- is used to select the circuit breaker and the ground fault circuit interruptor. Earth leakage circuit breaker</p>
TOCA Total overcurrent amps [A]	
MFA Maximum Fuse Ampere [A]	
MSC Maximum current of the starting compressor [A]	
RLA Rated load amps [A]	
OFM Outdoor fan motor	
IFM Indoor fan motor	
FLA Full Load Ampere [A]	
kW Fan motor rated output [kW]	

**3D120944D**



Detailed technical drawings

**RZAG-NV1 / RZAG-NY1**

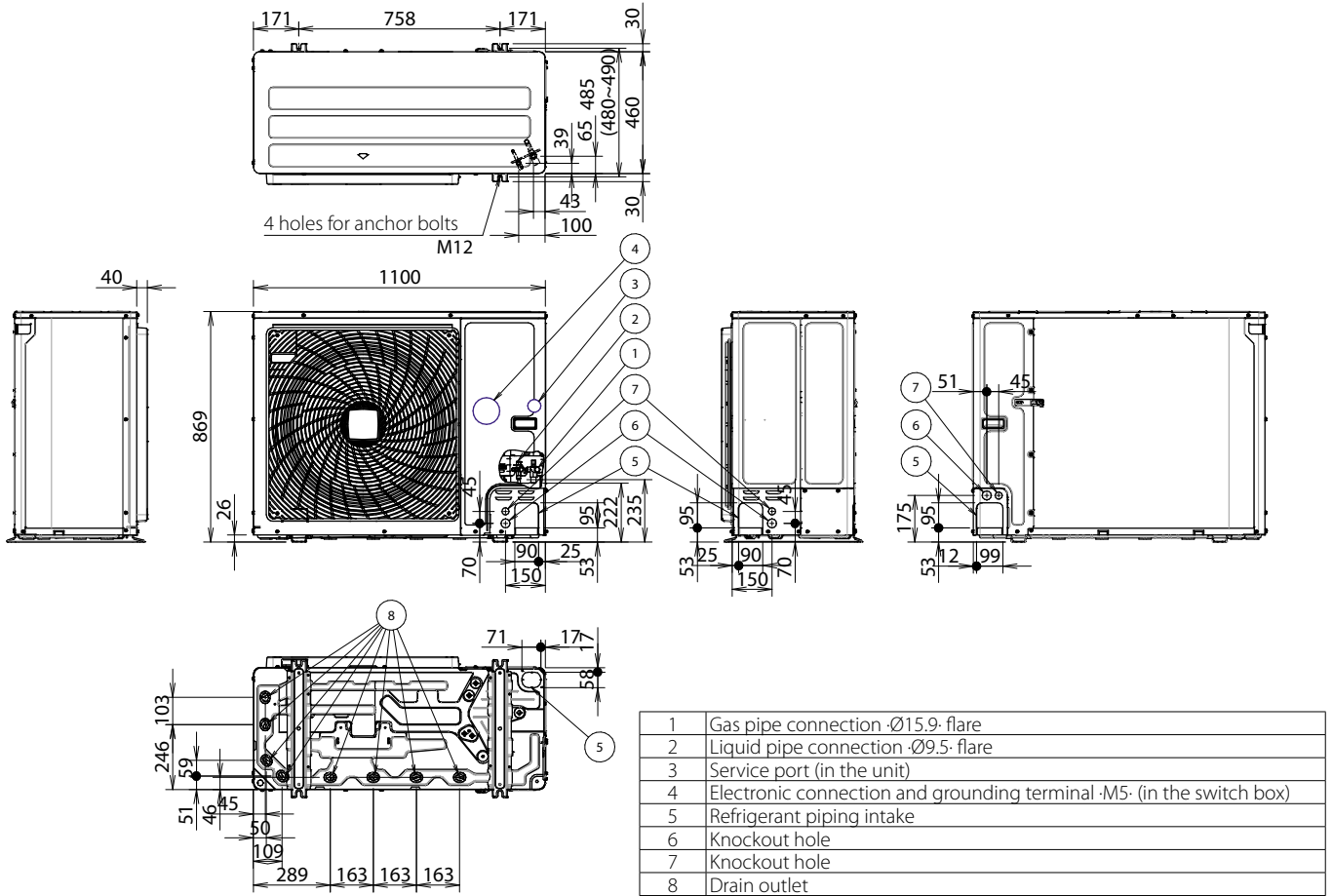

**3D120936**

**RZAG-NV1/NY1  
RZA-D**

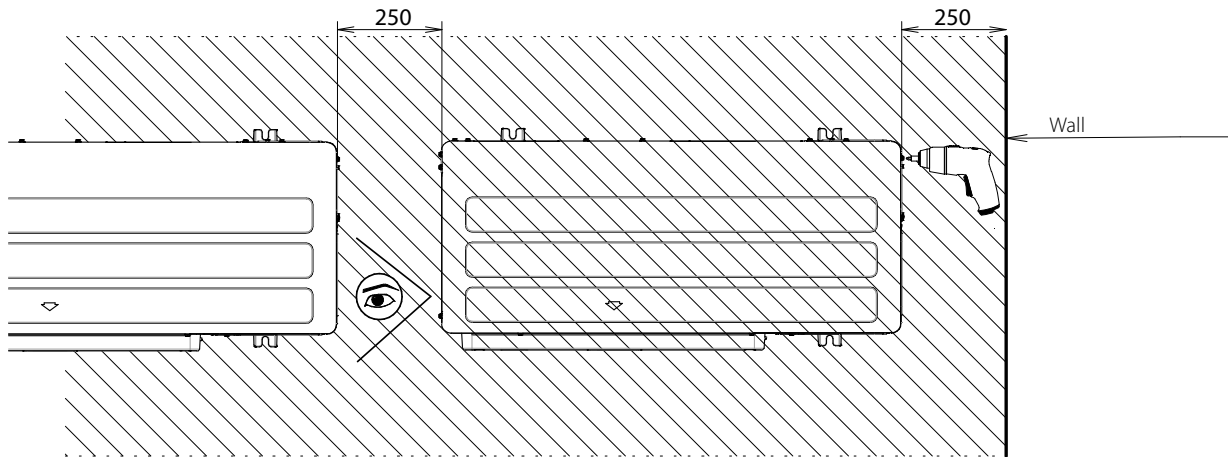

\* For optimal serviceability, provide ·250-mm of free space.  
For more installation and service space guidelines, see drawing ·3D069554·.

**3D110012**





**RZAG-NV1/NY1  
RZA-D**

<b>Suction side</b>	In the illustrations below, the service space at the suction side is based on 35°C DB and cooling operation. Foresee more space in the following cases: <ul style="list-style-type: none"> <li>• When the suction side temperature regularly exceeds this temperature.</li> <li>• When the heat load of the outdoor units is expected to regularly exceed the maximum operating capacity.</li> </ul>
<b>Discharge side</b>	Take refrigerant piping work into account when positioning the units. If your layout does not match with any of the layouts below, contact your dealer.

Single unit | Single row of units

	A~E	$H_b, H_D, H_U$	(mm)									
			a	b	c	d	e	$e_b$		$e_D$		
	B	—		≥100								
	A, B, C	—	≥100 <sup>(1)</sup>	≥100	≥100							
	B, E	—		≥100			≥1000			≤500		
	A, B, C, E	—	≥150 <sup>(1)</sup>	≥150	≥150		≥1000			≤500		
	D	—				≥500						
	D, E	—				≥500	≥1000	≥500				
	B, D	$H_D > H_U$ $H_D \leq H_U$		≥100	≥100	≥500	≥500					
	B, D, E	$H_D > H_U$	$H_b \leq \frac{1}{2}H_U$	≥250		≥750	≥1000	≤500			1	
			$\frac{1}{2}H_U < H_b \leq H_U$	≥250		≥1000	≥1000	≤500				
		$H_D \leq H_U$	$H_b > H_U$	⊘								
$H_b \leq \frac{1}{2}H_U$			≥100		≥1000	≥1000	≤500					
B, D, E	$H_D \leq H_U$	$\frac{1}{2}H_U < H_b \leq H_U$	≥200		≥1000	≥1000	≤500					
		$H_b > H_U$	⊘									
	A, B, C	—	≥200 <sup>(1)</sup>	≥300	≥1000							
	A, B, C, E	—	≥200 <sup>(1)</sup>	≥300	≥1000		≥1000			≤500		
	D	—				≥1000						
	D, E	—				≥1000	≥1000	≤500				
	B, D	$H_D > H_U$ $H_D \leq H_U$	$H_b > H_U$	≥300		≥1000						
			$H_b \leq H_U$	$H_b \leq \frac{1}{2}H_U$	≥250		≥1500					
	B, D, E	$H_D \leq H_U$	$\frac{1}{2}H_U < H_b \leq H_U$	≥300		≥1500						
			$H_D > H_U$	$H_b \leq \frac{1}{2}H_U$	≥300		≥1000	≥1000	≤500		1+2	
	$\frac{1}{2}H_U < H_b \leq H_U$	≥300			≥1250	≥1000	≤500					
	$H_b > H_U$	⊘										
B, D, E	$H_D \leq H_U$	$H_b \leq \frac{1}{2}H_U$	≥250		≥1500	≥1000	≤500					
		$\frac{1}{2}H_U < H_b \leq H_U$	≥300		≥1500	≥1000	≤500					
		$H_b > H_U$	⊘									

(1) For better serviceability, use a distance ≥250 mm

**A, B, C, D** Obstacles (walls/baffle plates)

**E** Obstacle (roof)

**a, b, c, d, e** Minimum service space between the unit and obstacles A, B, C, D and E

**eB** Maximum distance between the unit and the edge of obstacle E, in the direction of obstacle B

**eD** Maximum distance between the unit and the edge of obstacle E, in the direction of obstacle D

**H<sub>U</sub>** Height of the unit

**H<sub>B</sub>, H<sub>D</sub>** Height of obstacles B and D

1 Seal the bottom of the installation frame to prevent discharged air from flowing back to the suction side through the bottom of the unit.

2 Maximum two units can be installed.

⊘ Not allowed



### Detailed technical drawings

## RZAG-NV1/NY1 RZA-D

### Multiple rows of units

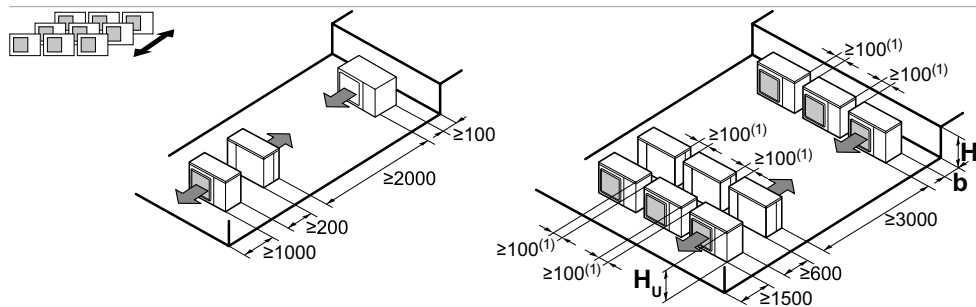

$H_b, H_u$	$b$ (mm)
$H_b \leq \frac{1}{2}H_u$	$b \geq 250$
$\frac{1}{2}H_u < H_b \leq H_u$	$b \geq 300$
$H_b > H_u$	

(1) For better serviceability, use a distance  $\geq 250$  mm

### Stacked units (max. 2 levels)



A1

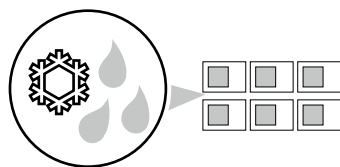

A2

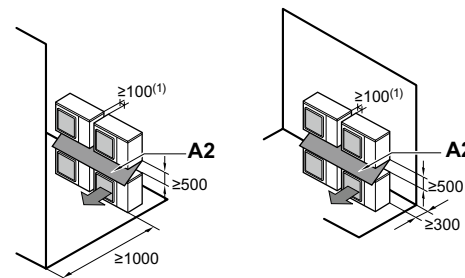

B1

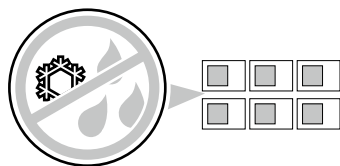

B2

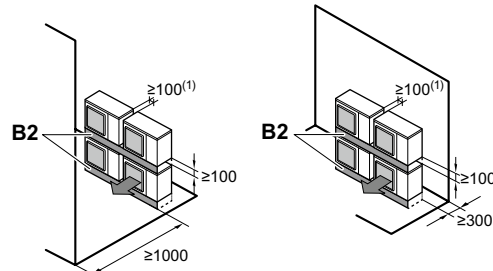

(1) For better serviceability, use a distance  $\geq 250$  mm

**A1=>A2** (A1) If there is danger of drainage dripping and freezing between the upper and lower units...

(A2) Then install a roof between the upper and lower units. Install the upper unit high enough above the lower unit to prevent ice buildup at the upper unit's bottom plate.

**B1=>B2** (B1) If there is no danger of drainage dripping and freezing between the upper and lower units...

(B2) Then it is not required to install a roof, but seal the gap between the upper and lower units to prevent discharged air from flowing back to the suction side through the bottom of the unit.



## RZAG-NV1/NY1

To determine if adding additional refrigerant is necessary

If	Then
$(L1+L2+L3+L4+L5+L6+L7) \leq$ chargeless length Chargeless length= 10 m (size-down) 40 m (standard) 15 m (size-up)	You do not have to add additional refrigerant.
$(L1+L2+L3+L4+L5+L6+L7) >$ chargeless length	You must add additional refrigerant. For future servicing, encircle the selected amount in the tables below.

### INFORMATION

Piping length is the largest one way length of liquid piping.

To determine the additional refrigerant amount (R in kg) (in case of pair)

Standard piping size:

	L1 (m)				
L1 (standard):	40~50 m	50~55 m	55~60 m	60~75 m	75~85 m
R:	0.35 kg	0.7 kg <sup>(a)</sup> 0.55 kg <sup>(b)</sup>	0.7 kg <sup>(a)</sup>	1.05 kg <sup>(a)</sup>	1.55 kg <sup>(a)</sup>

(a) Only for RZAG100~140.

(b) Only for RZAG71.

Size-up piping size:

	L1 (m)			
L1 (size-up):	15~20 m	20~25 m	20~25 m	30~35 m
R:	0.35 kg	0.7 kg	1.05 kg <sup>(a)</sup>	1.4 kg <sup>(a)</sup>

(a) Only for RZAG100~140.

To determine the additional refrigerant amount (R in kg) (in case of twin, triple and double twin)

1. Determine G1 and G2.

G1 (m)	Total length of <x> liquid piping x= Ø9.5 mm (standard) x= Ø12.7 mm (size-up)
G2 (m)	Total length of Ø6.4 mm liquid piping

2. Determine R1 and R2.

If	Then
$G1 > 40$ m <sup>(a)</sup>	Use the table below to determine R1 (length= $G1-40$ m) <sup>(a)</sup> and R2 (length=G2). R1=0.0 kg.
$G1 \leq 40$ m <sup>(a)</sup> (and $G1+G2 > 40$ m) <sup>(a)</sup>	Use the table below to determine R2 (length= $G1+G2-40$ m) <sup>(a)</sup>

(a) In case of size-up: Replace 40 m by 15 m.

In case of standard liquid pipe size:

	Length						
	0~10 m	10~15 m	15~20 m	20~30 m	30~40 m	40~45 m	
R1:	0.35 kg	0.7 kg <sup>(a)</sup> 0.55 kg <sup>(b)</sup>	0.7 kg <sup>(a)</sup>	1.05 kg <sup>(a)</sup>	1.4 kg <sup>(a)</sup>	1.55 kg <sup>(a)</sup>	
R2:	0.2 kg	0.4 kg	0.4 kg	0.6 kg	0.8 kg <sup>(a)</sup>	1 kg <sup>(a)</sup>	

In case of size-up liquid pipe size:

	Length							
	0~5 m	5~10 m	10~15 m	15~20 m	20~30 m	30~40m	40~45m	
R1:	0.35 kg	0.7 kg	1.05 kg <sup>(a)</sup>	1.4 kg <sup>(a)</sup>	-	-	-	
R2:	0.35 kg	0.35 kg	0.7 kg <sup>(a)</sup>	0.7 kg <sup>(a)</sup>	1.05 kg <sup>(a)</sup>	1.4 kg <sup>(a)</sup>	-	

(a) Only for RZAG100~140.

(b) Only for RZAG125-140.

3. Determine the additional refrigerant amount: R=R1+R2.

Examples

Layout	Additional refrigerant amount (R)
	Case: Twin, standard liquid pipe size 1. G1 Total Ø9.5 => G1=45 m G2 Total Ø6.4 => G2=7+5=12 m 2. Case: $G1 > 40$ m R1 Length= $G1-40$ m=5 m => R1=0.35 kg R2 Length= $G2$ =12 m => R2=0.4 kg 3. R R=R1+R2=0.35+0.4=0.75 kg
	Case: Triple, standard liquid pipe size 1. G1 Total Ø9.5 => G1=15 m G2 Total Ø6.4 => G2=20+17+17=54 m 2. Case: $G1 \leq 40$ m (and $G1+G2 > 40$ m) R1 R1=0.0 kg R2 Length= $G1+G2-40$ m=15+54-40=29 m => R2=0.6 kg 3. R R=R1+R2=0.0+0.6=0.6 kg



### RZASG71-100MV1

Indoor	Outdoor	Power supply	Voltage range	MCA	TOCA	MFA	Compressor		OFM		IFM			
							MSC	RLA	kW	FLA	kW	FLA		
FCAG35BVEB	x2 RZASG71M2V1B	50Hz ~ 220-240V	Minimum: -198 V- Maximum -264 V-	17.6	-	20	-	15.4	0.094	0.9	0.044 x2	0.3 x2		
FCAG71BVEB	RZASG71M2V1B			17.4	-	20	-	15.4	0.094	0.9	0.054	0.4		
FFA35A2VEB	x2 RZASG71M2V1B			17.8	-	20	-	15.4	0.094	0.9	0.050 x2	0.4 x2		
FBA35A2VEB	x2 RZASG71M2V1B			18.2	-	20	-	15.4	0.094	0.9	0.089 x2	0.6 x2		
FBA71A2VEB	RZASG71M2V1B			17.5	-	20	-	15.4	0.094	0.9	0.070	0.5		
FNA35A2VEB	x2 RZASG71M2V1B			17.3	-	20	-	15.4	0.094	0.9	0.034 x2	0.3		
FUA71AVEB9	RZASG71M2V1B			17.9	-	20	-	15.4	0.094	0.9	0.046	0.9		
FAA71BUBV1B	RZASG71M2V1B			17.4	-	20	-	15.4	0.094	0.9	0.048	0.4		
FVA71AMVEB	RZASG71M2V1B			17.6	-	20	-	15.4	0.094	0.9	0.117	0.6		
FDXM35F3V1B	x2 RZASG71M2V1B			17.6	-	20	-	15.4	0.094	0.9	0.034 x2	0.3 x2		
FHA35AVEB99	x2 RZASG71M2V1B			18.2	-	20	-	15.4	0.094	0.9	0.060 x2	0.6 x2		
FHA71AVEB99	RZASG71M2V1B			17.8	-	20	-	15.4	0.094	0.9	0.091	0.8		
FCAG35BVEB	x3 RZASG100M7V1B			50Hz ~ 220-240V	Minimum: -198 V- Maximum -264 V-	21.7	-	25	-	19.0	0.200	1.0	0.044 x3	0.3 x3
FCAG50BVEB	x2 RZASG100M7V1B					21.4	-	25	-	19.0	0.200	1.0	0.039 x2	0.3 x2
FCAG100BVEB	RZASG100M7V1B					21.5	-	25	-	19.0	0.200	1.0	0.117	0.7
FFA35A2VEB	x3 RZASG100M7V1B					22.0	-	25	-	19.0	0.200	1.0	0.050 x3	0.4 x3
FFA50A2VEB	x2 RZASG100M7V1B	21.6	-			25	-	19.0	0.200	1.0	0.050 x2	0.4 x2		
FBA35A2VEB	x3 RZASG100M7V1B	22.7	-			25	-	19.0	0.200	1.0	0.089 x3	0.6 x3		
FBA50A2VEB	x2 RZASG100M7V1B	22.0	-			25	-	19.0	0.200	1.0	0.089 x2	0.6 x2		
FBA100A2VEB	RZASG100M7V1B	21.8	-			25	-	19.0	0.200	1.0	0.127	1.0		
FNA35A2VEB	x3 RZASG100M7V1B	21.7	-			25	-	19.0	0.200	1.0	0.034 x3	0.3 x3		
FNA50A2VEB	x2 RZASG100M7V1B	21.8	-			25	-	19.0	0.200	1.0	0.060 x2	0.5 x2		
FUA100AVEB9	RZASG100M7V1B	22.2	-			25	-	19.0	0.200	1.0	0.106	1.3		
FAA100BUBV1B	RZASG100M7V1B	21.7	-			25	-	19.0	0.200	1.0	0.064	0.4		
FVA100AMVEB	RZASG100M7V1B	22.0	-			25	-	19.0	0.200	1.0	0.238	1.2		
FDXM35F3V1B	x3 RZASG100M7V1B	21.7	-			25	-	19.0	0.200	1.0	0.034 x3	0.3 x3		
FDXM50F3V1B	x2 RZASG100M7V1B	21.8	-			25	-	19.0	0.200	1.0	0.060 x2	0.5 x2		
FHA35AVEB99	x3 RZASG100M7V1B	22.7	-			25	-	19.0	0.200	1.0	0.060 x3	0.6 x3		
FHA50AVEB99	x2 RZASG100M7V1B	22.0	-	25	-	19.0	0.200	1.0	0.060 x2	0.6 x2				
FHA100AVEB99	RZASG100M7V1B	22.2	-	25	-	19.0	0.200	1.0	0.150	1.3				

RZASG71-100MV1

**3D110014G**

### RZASG125-140MV1

Indoor	Outdoor	Power supply	Voltage range	MCA	TOCA	MFA	Compressor		OFM		IFM	
							MSC	RLA	kW	FLA	kW	FLA
FCAG35BVEB	x4 RZASG125M7V1B	50Hz ~ 220-240V	Minimum: -198 V- Maximum -264 V-	28.0	-	32	-	24.7	0.200	1.0	0.044 x4	0.3 x4
FCAG50BVEB	x3 RZASG125M7V1B			27.7	-	32	-	24.7	0.200	1.0	0.039 x3	0.3 x3
FCAG60BVEB	x2 RZASG125M7V1B			27.4	-	32	-	24.7	0.200	1.0	0.044 x2	0.3 x2
FCAG125BVEB	RZASG125M7V1B			27.8	-	32	-	24.7	0.200	1.0	0.168	1.0
FFA35A2VEB	x4 RZASG125M7V1B			28.4	-	32	-	24.7	0.200	1.0	0.050 x4	0.4 x4
FFA50A2VEB	x3 RZASG125M7V1B			28.0	-	32	-	24.7	0.200	1.0	0.050 x3	0.4 x3
FFA60A2VEB	x2 RZASG125M7V1B			28.0	-	32	-	24.7	0.200	1.0	0.050 x2	0.6 x2
FBA35A2VEB	x4 RZASG125M7V1B			29.2	-	32	-	24.7	0.200	1.0	0.089 x4	0.6 x4
FBA50A2VEB	x3 RZASG125M7V1B			28.6	-	32	-	24.7	0.200	1.0	0.089 x3	0.6 x3
FBA60A2VEB	x2 RZASG125M7V1B			27.8	-	32	-	24.7	0.200	1.0	0.070 x2	0.5 x2
FBA125A2VEB	RZASG125M7V1B			28.3	-	32	-	24.7	0.200	1.0	0.187	1.5
FNA35A2VEB	x4 RZASG125M7V1B			28.0	-	32	-	24.7	0.200	1.0	0.034 x4	0.3 x4
FNA50A2VEB	x3 RZASG125M7V1B			28.3	-	32	-	24.7	0.200	1.0	0.060 x3	0.5 x3
FNA60A2VEB	x2 RZASG125M7V1B			27.8	-	32	-	24.7	0.200	1.0	0.060 x2	0.5 x2
FUA125AVEB9	RZASG125M7V1B			28.2	-	32	-	24.7	0.200	1.0	0.106	1.4
FDA125AVEB9	RZASG125M7V1B			28.9	-	32	-	24.7	0.200	1.0	0.350	2.1
FVA125AMVEB	RZASG125M7V1B	28.0	-	32	-	24.7	0.200	1.0	0.238	1.2		
FDXM35F3V1B	x4 RZASG125M7V1B	28.0	-	32	-	24.7	0.200	1.0	0.034 x4	0.3 x4		
FDXM50F3V1B	x3 RZASG125M7V1B	28.3	-	32	-	24.7	0.200	1.0	0.060 x3	0.5 x3		
FDXM60F3V1B	x2 RZASG125M7V1B	27.8	-	32	-	24.7	0.200	1.0	0.060 x2	0.5 x2		
FHA35AVEB99	x4 RZASG125M7V1B	29.2	-	32	-	24.7	0.200	1.0	0.060 x4	0.6 x4		
FHA50AVEB99	x3 RZASG125M7V1B	28.6	-	32	-	24.7	0.200	1.0	0.060 x3	0.6 x3		
FHA60AVEB99	x2 RZASG125M7V1B	28.0	-	32	-	24.7	0.200	1.0	0.091 x2	0.6 x2		
FHA125AVEB99	RZASG125M7V1B	28.3	-	32	-	24.7	0.200	1.0	0.150	1.5		
FCAG35BVEB	x4 RZASG140M7V1B	50Hz ~ 220-240V	Minimum: -198 V- Maximum -264 V-	27.2	-	32	-	24.0	0.200	1.0	0.044 x4	0.3 x4
FCAG50BVEB	x3 RZASG140M7V1B			26.9	-	32	-	24.0	0.200	1.0	0.039 x3	0.3 x3
FCAG71BVEB	x2 RZASG140M7V1B			26.8	-	32	-	24.0	0.200	1.0	0.054 x2	0.4 x2
FCAG140BVEB	RZASG140M7V1B			27.0	-	32	-	24.0	0.200	1.0	0.168	1.0
FFA35A2VEB	x4 RZASG140M7V1B			27.7	-	32	-	24.0	0.200	1.0	0.050 x4	0.4 x4
FFA50A2VEB	x3 RZASG140M7V1B			27.2	-	32	-	24.0	0.200	1.0	0.050 x3	0.4 x3
FBA35A2VEB	x4 RZASG140M7V1B			28.5	-	32	-	24.0	0.200	1.0	0.089 x4	0.6 x4
FBA50A2VEB	x3 RZASG140M7V1B			27.9	-	32	-	24.0	0.200	1.0	0.089 x3	0.6 x3
FBA71A2VEB	x2 RZASG140M7V1B			27.0	-	32	-	24.0	0.200	1.0	0.070 x2	0.5 x2
FBA140A2VEB	RZASG140M7V1B			27.6	-	32	-	24.0	0.200	1.0	0.187	1.5
FNA35A2VEB	x4 RZASG140M7V1B			27.2	-	32	-	24.0	0.200	1.0	0.034 x4	0.3 x4
FNA50A2VEB	x3 RZASG140M7V1B			27.6	-	32	-	24.0	0.200	1.0	0.060 x3	0.5 x3
FUA71AVEB9	x2 RZASG140M7V1B			27.9	-	32	-	24.0	0.200	1.0	0.046 x2	0.9 x2
FAA71BUBV1B	x2 RZASG140M7V1B			26.8	-	32	-	24.0	0.200	1.0	0.048 x2	0.4 x2
FVA71AMVEB	x2 RZASG140M7V1B			27.2	-	32	-	24.0	0.200	1.0	0.117 x2	0.6 x2
FVA140AMVEB	RZASG140M7V1B			27.5	-	32	-	24.0	0.200	1.0	0.276	1.4
FDXM35F3V1B	x4 RZASG140M7V1B	27.2	-	32	-	24.0	0.200	1.0	0.034 x4	0.3 x4		
FDXM50F3V1B	x3 RZASG140M7V1B	27.6	-	32	-	24.0	0.200	1.0	0.060 x3	0.5 x3		
FHA35AVEB99	x4 RZASG140M7V1B	28.5	-	32	-	24.0	0.200	1.0	0.060 x4	0.6 x4		
FHA50AVEB99	x3 RZASG140M7V1B	27.9	-	32	-	24.0	0.200	1.0	0.060 x3	0.6 x3		
FHA71AVEB99	x2 RZASG140M7V1B	27.7	-	32	-	24.0	0.200	1.0	0.091 x2	0.8 x2		
FHA140AVEB99	RZASG140M7V1B	27.9	-	32	-	24.0	0.200	1.0	0.150	1.8		

RZASG125-140MV1

**3D110014G**



## RZASG100MY1

Indoor	Outdoor	Power supply	Voltage range	MCA	TOCA	MFA	Compressor		OFM		IFM	
							MSC	RLA	kW	FLA	kW	FLA
FCAG35BVEB	x3 RZASG100M7Y1B	3N~ 50Hz 380-415V	Minimum: -342 V- Maximum -456 V-	13.0	--	16	--	10.6	0.200	1.0	0.044 x3	0.3 x3
FCAG50BVEB	x2 RZASG100M7Y1B			12.7	--	16	--	10.6	0.200	1.0	0.039 x2	0.3 x2
FCAG100BVEB	RZASG100M7Y1B			14.2	--	16	--	12.0	0.200	1.0	0.117	0.7
FFA35A2VEB	x3 RZASG100M7Y1B			13.3	--	16	--	10.6	0.200	1.0	0.050 x3	0.4 x3
FFA50A2VEB	x2 RZASG100M7Y1B			12.9	--	16	--	10.6	0.200	1.0	0.050 x2	0.4 x2
FBA35A2VEB	x3 RZASG100M7Y1B			13.9	--	16	--	10.6	0.200	1.0	0.089 x3	0.6 x3
FBA50A2VEB	x2 RZASG100M7Y1B			13.3	--	16	--	10.6	0.200	1.0	0.089 x2	0.6 x2
FBA100A2VEB	RZASG100M7Y1B			14.6	--	16	--	12.0	0.200	1.0	0.127	1.0
FNA35A2VEB	x3 RZASG100M7Y1B			13.0	--	16	--	10.6	0.200	1.0	0.034 x3	0.3 x3
FNA50A2VEB	x2 RZASG100M7Y1B			13.1	--	16	--	10.6	0.200	1.0	0.060 x2	0.5 x2
FUA100AVEB9	RZASG100M7Y1B			14.9	--	16	--	12.0	0.200	1.0	0.106	1.3
FAA100BUV1B	RZASG100M7Y1B			14.4	--	16	--	12.0	0.200	1.0	0.064	0.4
FVA100AMVEB	RZASG100M7Y1B			14.8	--	16	--	12.0	0.200	1.0	0.238	1.2
FDXM35F3V1B	x3 RZASG100M7Y1B			13.0	--	16	--	10.6	0.200	1.0	0.034 x3	0.3 x3
FDXM50F3V1B	x2 RZASG100M7Y1B			13.1	--	16	--	10.6	0.200	1.0	0.060 x2	0.5 x2
FHA35AVEB99	x3 RZASG100M7Y1B			13.9	--	16	--	10.6	0.200	1.0	0.060 x3	0.6 x3
FHA50AVEB99	x2 RZASG100M7Y1B			13.3	--	16	--	10.6	0.200	1.0	0.060 x2	0.6 x2
FHA100AVEB99	RZASG100M7Y1B			14.9	--	16	--	12.0	0.200	1.0	0.150	1.3

RZASG100MY1

**3D110014G**

## RZASG125-140MY1

Indoor	Outdoor	Power supply	Voltage range	MCA	TOCA	MFA	Compressor		OFM		IFM	
							MSC	RLA	kW	FLA	kW	FLA
FCAG35BVEB	x4 RZASG125M7Y1B	3N~ 50Hz 380-415V	Minimum: -342 V- Maximum -456 V-	12.2	--	16	--	9.5	0.200	1.0	0.044 x4	0.3 x4
FCAG50BVEB	x3 RZASG125M7Y1B			13.0	--	16	--	10.6	0.200	1.0	0.039 x3	0.3 x3
FCAG60BVEB	x2 RZASG125M7Y1B			12.7	--	16	--	10.6	0.200	1.0	0.044 x2	0.3 x2
FCAG125BVEB	RZASG125M7Y1B			14.6	--	16	--	12.0	0.200	1.0	0.168	1.0
FFA35A2VEB	x4 RZASG125M7Y1B			12.6	--	16	--	9.5	0.200	1.0	0.050 x4	0.4 x4
FFA50A2VEB	x3 RZASG125M7Y1B			13.3	--	16	--	10.6	0.200	1.0	0.050 x3	0.4 x3
FFA60A2VEB	x2 RZASG125M7Y1B			13.3	--	16	--	10.6	0.200	1.0	0.050 x2	0.6 x2
FBA35A2VEB	x4 RZASG125M7Y1B			13.4	--	16	--	9.5	0.200	1.0	0.089 x4	0.6 x4
FBA50A2VEB	x3 RZASG125M7Y1B			13.9	--	16	--	10.6	0.200	1.0	0.089 x3	0.6 x3
FBA60A2VEB	x2 RZASG125M7Y1B			13.1	--	16	--	10.6	0.200	1.0	0.070 x2	0.5 x2
FBA125A2VEB	RZASG125M7Y1B			15.1	--	16	--	12.0	0.200	1.0	0.187	1.5
FNA35A2VEB	x4 RZASG125M7Y1B			12.2	--	16	--	9.5	0.200	1.0	0.034 x4	0.3 x4
FNA50A2VEB	x3 RZASG125M7Y1B			13.6	--	16	--	10.6	0.200	1.0	0.060 x3	0.5 x3
FNA60A2VEB	x2 RZASG125M7Y1B			13.1	--	16	--	10.6	0.200	1.0	0.060 x2	0.5 x2
FUA125AVEB9	RZASG125M7Y1B			15.0	--	16	--	12.0	0.200	1.0	0.106	1.4
FDA125AVEB9	RZASG125M7Y1B			15.7	--	16	--	12.0	0.200	1.0	0.350	2.1
FVA125AMVEB	RZASG125M7Y1B			14.8	--	16	--	12.0	0.200	1.0	0.238	1.2
FDXM35F3V1B	x4 RZASG125M7Y1B			12.2	--	16	--	9.5	0.200	1.0	0.034 x4	0.3 x4
FDXM50F3V1B	x3 RZASG125M7Y1B			13.6	--	16	--	10.6	0.200	1.0	0.060 x3	0.5 x3
FDXM60F3V1B	x2 RZASG125M7Y1B			13.1	--	16	--	10.6	0.200	1.0	0.060 x2	0.5 x2
FHA35AVEB99	x4 RZASG125M7Y1B	13.4	--	16	--	9.5	0.200	1.0	0.060 x4	0.6 x4		
FHA50AVEB99	x3 RZASG125M7Y1B	13.9	--	16	--	10.6	0.200	1.0	0.060 x3	0.6 x3		
FHA60AVEB99	x2 RZASG125M7Y1B	13.3	--	16	--	10.6	0.200	1.0	0.091 x2	0.6 x2		
FHA125AVEB99	RZASG125M7Y1B	15.1	--	16	--	12.0	0.200	1.0	0.150	1.5		
FCAG35BVEB	x4 RZASG140M7Y1B	3N~ 50Hz 380-415V	Minimum: -342 V- Maximum -456 V-	12.2	--	16	--	9.5	0.200	1.0	0.044 x4	0.3 x4
FCAG50BVEB	x3 RZASG140M7Y1B			12.9	--	16	--	10.5	0.200	1.0	0.039 x3	0.3 x3
FCAG71BVEB	x2 RZASG140M7Y1B			14.4	--	16	--	12.0	0.200	1.0	0.054 x2	0.4 x2
FCAG140BVEB	RZASG140M7Y1B			14.6	--	16	--	12.0	0.200	1.0	0.168	1.0
FFA35A2VEB	x4 RZASG140M7Y1B			12.6	--	16	--	9.5	0.200	1.0	0.050 x4	0.4 x4
FFA50A2VEB	x3 RZASG140M7Y1B			13.2	--	16	--	10.5	0.200	1.0	0.050 x3	0.4 x3
FBA35A2VEB	x4 RZASG140M7Y1B			13.4	--	16	--	9.5	0.200	1.0	0.089 x4	0.6 x4
FBA50A2VEB	x3 RZASG140M7Y1B			13.8	--	16	--	10.5	0.200	1.0	0.089 x3	0.6 x3
FBA71A2VEB	x2 RZASG140M7Y1B			14.6	--	16	--	12.0	0.200	1.0	0.070 x2	0.5 x2
FBA140A2VEB	RZASG140M7Y1B			15.1	--	16	--	12.0	0.200	1.0	0.187	1.5
FNA35A2VEB	x4 RZASG140M7Y1B			12.2	--	16	--	9.5	0.200	1.0	0.034 x4	0.3 x4
FNA50A2VEB	x3 RZASG140M7Y1B			13.5	--	16	--	10.5	0.200	1.0	0.060 x3	0.5 x3
FUA71AVEB9	x2 RZASG140M7Y1B			15.4	--	16	--	12.0	0.200	1.0	0.046 x2	0.9 x2
FAA71BUV1B	x2 RZASG140M7Y1B			14.4	--	16	--	12.0	0.200	1.0	0.048 x2	0.4 x2
FVA71AMVEB	x2 RZASG140M7Y1B			14.8	--	16	--	12.0	0.200	1.0	0.117 x2	0.6 x2
FVA140AMVEB	RZASG140M7Y1B			15.0	--	16	--	12.0	0.200	1.0	0.276	1.4
FDXM35F3V1B	x4 RZASG140M7Y1B			12.2	--	16	--	9.5	0.200	1.0	0.034 x4	0.3 x4
FDXM50F3V1B	x3 RZASG140M7Y1B			13.5	--	16	--	10.5	0.200	1.0	0.060 x3	0.5 x3
FHA35AVEB99	x4 RZASG140M7Y1B			13.4	--	16	--	9.5	0.200	1.0	0.060 x4	0.6 x4
FHA50AVEB99	x3 RZASG140M7Y1B			13.8	--	16	--	10.5	0.200	1.0	0.060 x3	0.6 x3
FHA71AVEB99	x2 RZASG140M7Y1B	15.2	--	16	--	12.0	0.200	1.0	0.091 x2	0.8 x2		
FHA140AVEB99	RZASG140M7Y1B	15.4	--	16	--	12.0	0.200	1.0	0.150	1.8		

RZASG125-140MY1

**3D110014G**

**RZASG-MV1/MY1**

Symbols	Notes
MCA Minimum Circuit Ampere [A] TOCA Total overcurrent amps [A] MFA Maximum Fuse Ampere [A] MSC Maximum current of the starting compressor [A] RLA Rated load amps [A] OFM Outdoor fan motor IFM Indoor fan motor FLA Full Load Ampere [A] KW Fan motor rated output [kW]	<p>1 The -RLA- is based on the following conditions.</p> <p>Cooling Indoor temperature -27.0°C DB / -19.0°C WB Outdoor temperature -35.0°C DB</p> <p>Heating Indoor temperature -20.0°C DB Outdoor temperature -7.0°C DB / -6.0°C WB</p> <p>2 -TOCA- is the total value of each overcurrent set.</p> <p>3 Voltage range The units are suitable for use with electrical systems in which the voltage supplied to the unit terminals is not below or above the listed range limits.</p> <p>4 The maximum allowable voltage that is unbalanced between phases is -2%.</p> <p>5 -MCA- is the maximum input current. The capacity of the -MFA- must be greater than that of the -MCA-. Select the -MFA- according to the table.</p> <p>6 Select the wire size according to the MCA.</p> <p>7 -MFA- is used to select the circuit breaker and the ground fault circuit interruptor. Earth leakage circuit breaker</p>

**3D110014G**

**RZASG71MV1**

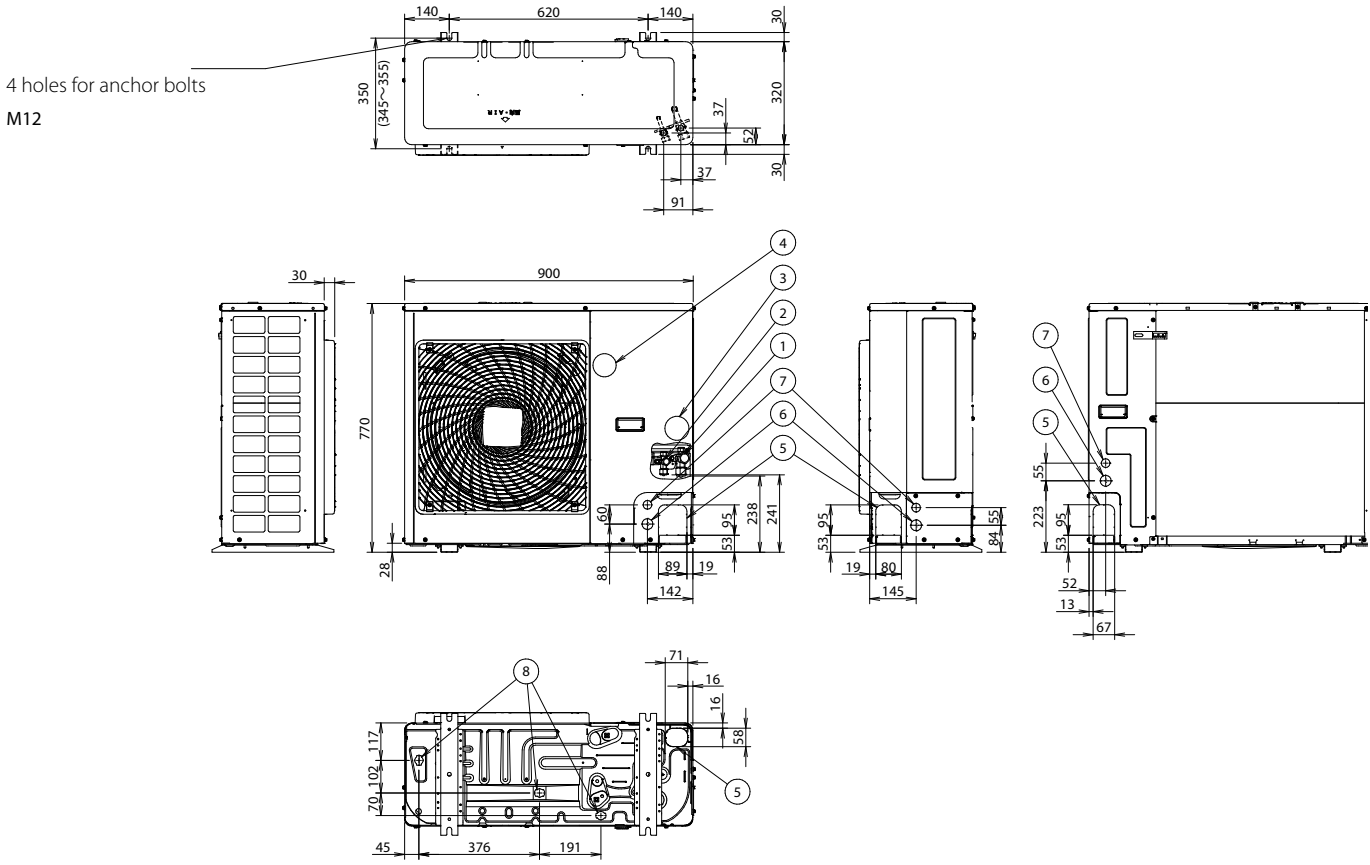

1	Gas pipe connection -Ø15.9- flare
2	Liquid pipe connection -Ø9.5- flare
3	Service port (in the unit)
4	Electronic connection and grounding terminal -M5- (in the switch box)
5	Refrigerant piping intake
6	Power supply wiring intake (knockout hole Ø34)
7	Control wiring intake (knockout hole Ø27)
8	Drain outlet

**3D110013**

**RZASG100-140MV1/MY1**

4 holes for anchor bolts  
M12

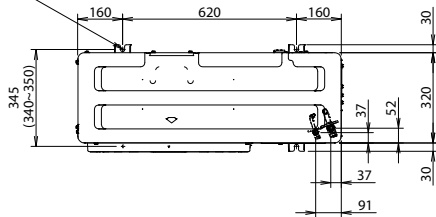

Model	AA	AB
RZAG71* / RZASG100-125* / AZAS100-125*	331	337
RZASG140* / AZAS140*	414	420

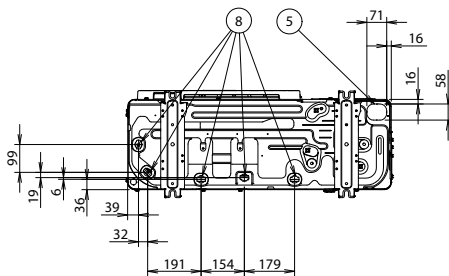
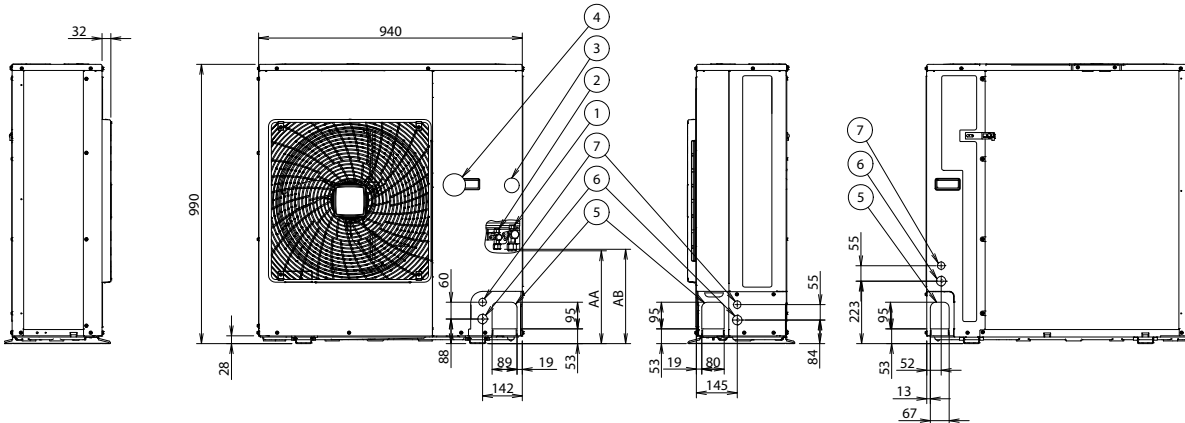

1	Gas pipe connection ·Ø15.9· flare
2	Liquid pipe connection ·Ø9.5· flare
3	Service port (in the unit)
4	Electronic connection and grounding terminal ·M5· (in the switch box)
5	Refrigerant piping intake
6	Power supply wiring intake (knockout hole Ø34)
7	Control wiring intake (knockout hole Ø27)
8	Drain outlet

**3D110011**



### RZASG-MV1/MY1

#### Installation service space

The measure of these values is "mm".

#### (A) When there are obstacles on suction sides.

**• No obstacle above**

(1) Stand-alone installation

- Obstacle on the suction side only

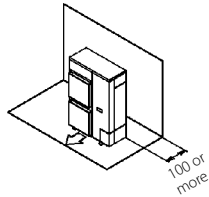

- Obstacle on both sides and suction side, too

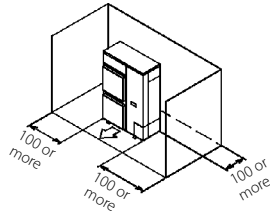

(2) Series installation (2 or more) (note 1)

- Obstacle on the suction side and both sides

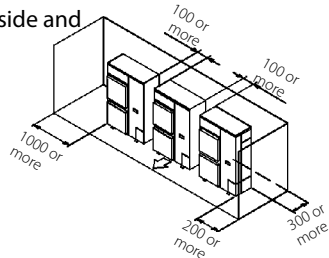

**• Obstacle above, too**

(1) Stand-alone installation

- Obstacle on the suction side, too

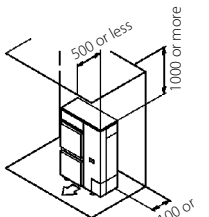

- Obstacle on both sides and suction side, too

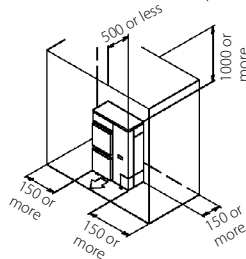

(2) Series installation (2 or more) (note 1)

- Obstacle on the suction side and both sides

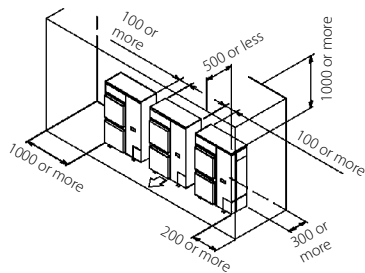

#### (B) When there are obstacles on discharge sides.

**• No obstacle above**

(1) Stand-alone installation

- Obstacle on the discharge side only

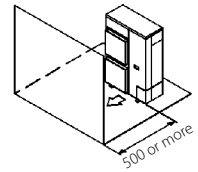

(2) Series installation (2 or more) (note 1)

- Obstacle on the suction side only

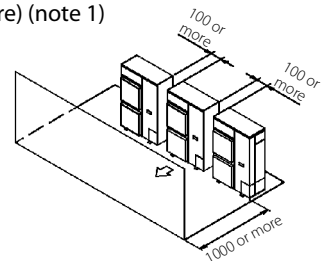

**• Obstacle above, too**

(1) Stand-alone installation

- Obstacle on the discharge side only, too

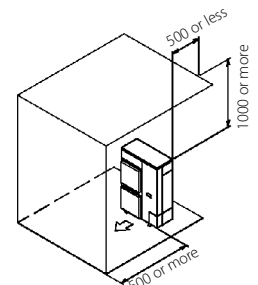

(2) Series installation (2 or more) (note 1)

- Obstacle on discharge side

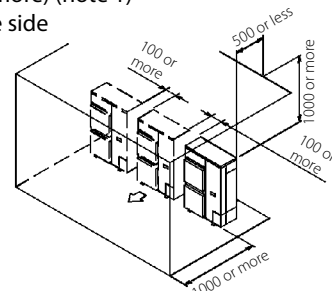

#### (C) When there are obstacles on both suction and discharge sides:

##### Pattern 1

When the obstacles on the discharge side is higher than the unit. (L > H)

(There is no limit for the height of obstructions on the suction side.)

**• No obstacle above**

(1) Stand-alone installation

- No obstacle above

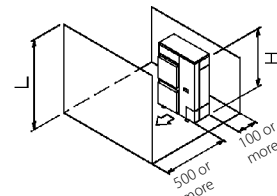

(2) Series installation (2 or more) (note 1)

- No obstacle above

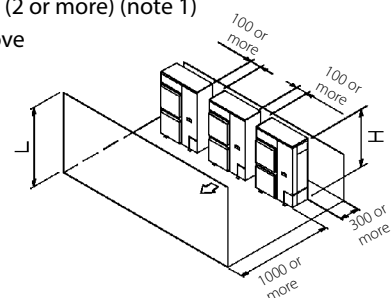

3D069554





**RZASG-MV1/MY1**

**• Obstacle above, too**

(1) Stand-alone installation (note 2)

- When there are obstacles on suction, discharge and top sides.

The relations between H, A and L are as follows:

	L	A
$L \leq H$	$L \leq 1/2H$	750 or more
	$1/2H < L \leq H$	1000 or more
$H < L$	Set the stand as: $L \leq H$ Refer to the column of $L \leq H$ for A	

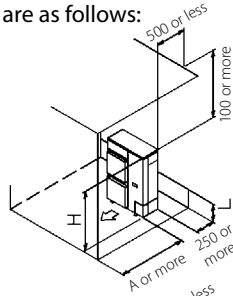

(2) Series installation (2 or more) (note 1,2)

- When there are obstacles on suction, discharge and top sides.
- The relations between H, A and L are as follows:

	L	A
$L \leq H$	$L \leq 1/2H$	1000 or more
	$1/2H < L \leq H$	1250 or more
$H < L$	Set the stand as: $L \leq H$ Refer to the column of $L \leq H$ for A	

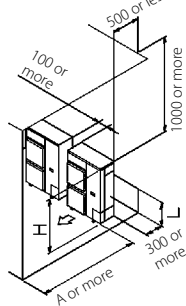

Limit of series installation is 2 units.

**Pattern 2**

When the obstacle on the discharge side is lower than the unit ( $L \leq H$ )

(There is no limit for the height of obstructions on the suction side.)

**• No obstacle above**

(1) Stand-alone installation

- No obstacle above

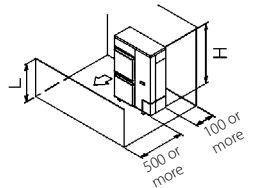

(2) Series installation (2 or more) (note 1, 2)

- When there are obstacles on both suction and discharge sides.
- The relations between H, A and L are as follows.

	L	A
$L \leq 1/2H$	$L \leq 1/2H$	250 or more
	$1/2H < L \leq H$	300 or more

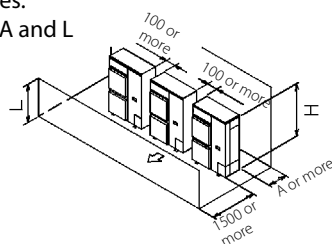

**• Obstacle above**

(1) Stand-alone installation (note 2)

- When there are obstacles on suction, discharge and top sides.

The relations between H, A and L are as follows.

	L	A
$L \leq H$	$L \leq 1/2H$	100 or more
	$1/2H < L \leq H$	200 or more
$H < L$	Set the stand as: $L \leq H$ Refer to the column of $L \leq H$ for A	

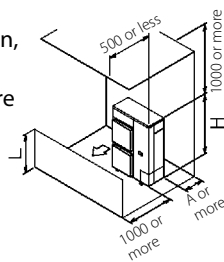

(2) Series installation (2 or more) (note 1,2)

- When there are obstacles on suction, discharge and top sides.
- The relations between H, A and L are as follows.

	L	A
$L \leq H$	$L \leq 1/2H$	250 or more
	$1/2H < L \leq H$	300 or more
$H < L$	Set the stand as: $L \leq H$ Refer to the column of $L \leq H$ for A	

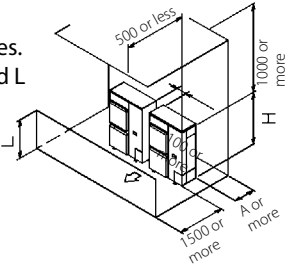

Limit of series installation is 2 units.

**(D) Double-decker installation**

(1) Obstacle on the discharge side. (1)

- Do not exceed two levels for stacked installation.
- Install a roof cover similar to A (field supply), as outdoor units with downward drainage are prone to dripping and freezing.
- Install the upper-level outdoor unit so that its bottom plate is a sufficient height above the roof cover. This is to prevent the buildup of ice on the underside of the bottom plate.

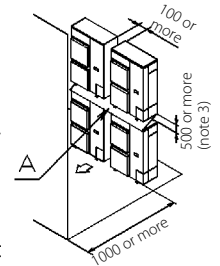

(2) Obstacle on the suction side. (1)

- Do not exceed two levels for stacked installation.
- Install a roof cover similar to A (field supply), as outdoor units with downward drainage are prone to dripping and freezing.
- Install the upper-level outdoor unit so that its bottom plate is a sufficient height above the roof cover. This is to prevent the buildup of ice on the underside of the bottom plate.

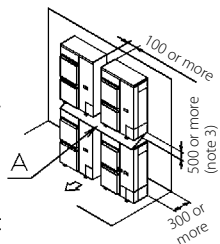

**(E) Multiple rows of series installation (on the rooftop, etc.)**

(1) One row of stand-alone installation

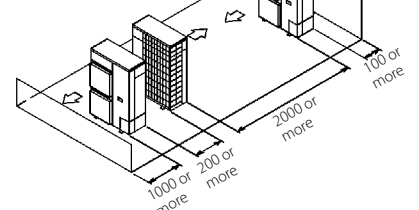

(2) Rows of series installation (2 or more)

The relations between H, A and L are as follows.

	L	A
$L \leq H$	$L \leq 1/2H$	1000 or more
	$1/2H < L \leq H$	1250 or more
$H < L$	Set the stand as: $L \leq H$ Refer to the column of $L \leq H$ for A	

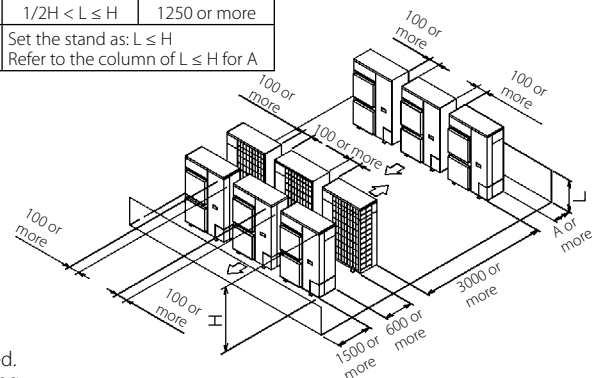

**NOTES**

1. In case of the sideways's piping, make a 100mm gap between the unit above.
2. Close the bottom of the installation frame to prevent the discharged air from being bypassed.
3. It is not necessary to install a roof cover if there is no danger of drainage dripping and freezing. In this case, the space between the upper and lower outdoor units should be at least 100mm. Close off the gap between the upper and lower units so there is no re intake of discharged air.

## RZASG-MV1/MY1

### To determine if adding additional refrigerant is necessary

if	Then
$(L1+L2+L3+L4+L5+L6+L7) \leq 30$ m (chargeless length)	You do not have to add additional refrigerant.
$(L1+L2+L3+L4+L5+L6+L7) > 30$ m (chargeless length)	You must add additional refrigerant. For future servicing, encircle the selected amount in the tables below.

### INFORMATION

Piping length is the largest one way length of liquid piping.

### To determine the additional refrigerant amount (R in kg) (in case of pair)

	L1 (m)	
	30~40 m	40~50 m
<b>L1:</b>		
<b>R:</b>	0.35 kg	0.7 kg

### To determine the additional refrigerant amount (R in kg) (in case of twin, triple and double twin)

#### 1. Determine R1 and R2.

if	Then
$G1 > 30$ m	Use the table below to determine R1
$G1 \leq 30$ m (and $G1+G2 > 30$ m)	$R1 = 0.0$ kg. Use the table below to determine R2.

	Length (total length of liquid piping - 30 m)				
	0~10 m	10~20 m	20~30 m	30~40 m	40~45 m
<b>R1:</b>	0.35 kg	0.7 kg	1.05 kg <sup>(a)</sup>	1.4 kg <sup>(a)</sup>	
<b>R2:</b>	0.2 kg	0.4 kg	0.6 kg	0.8 kg <sup>(a)</sup>	1 kg <sup>(b)</sup>

a) Only for RZASG100~140.

b) Only for RZASG100+125.

#### 2. Determine the additional refrigerant amount: $R=R1+R2$ .

#### Examples

Layout	Additional refrigerant amount (R)	
	Case: Twin, standard liquid pipe size	
	1.	G1 Total Ø9.5 => G1=35 m G2 Total Ø6.4 => G2=7+5=12 m
	2.	Case: $G1 > 30$ m R1 Length= $G1 - 30$ m = 5 m => $R1 = 0.35$ kg R2 Length= $G2 = 12$ m => $R2 = 0.4$ kg
	3.	R = $R1 + R2 = 0.35 + 0.4 = 0.75$ kg
	Case: Triple, standard liquid pipe size	
	1.	G1 Total Ø9.5 => G1=5 m G2 Total Ø6.4 => G2=15+12+17=44 m
	2.	Case: $G1 \leq 30$ m (and $G1+G2 > 30$ m) R1 $R1 = 0.0$ kg R2 Length= $G1 + G2 - 30$ m = 5+44-30=19 m => $R2 = 0.4$ kg
	3.	R = $R1 + R2 = 0.0 + 0.4 = 0.4$ kg

RZA-D

Indoor	Outdoor	Power supply	Voltage range	MCA	TOCA	MFA	Compressor		OFM		IFM
							MSC	RLA	kW	FLA	FLA
FDA200A2VEB	RZA200D7Y1B	3N~ 50Hz 380-415V	Minimum: -342 V. Maximum: -457 V.	(15.9)*	-	20	-	14.0	0.6	1.3	4.0
FCAG50BVEB	x4 RZA200D7Y1B			16.1	-	20	-	13.0	0.6	1.3	0.3 x4
FCAG60BVEB	x3 RZA200D7Y1B			16.7	-	20	-	13.9	0.6	1.3	0.3 x3
FCAG71BVEB	x3 RZA200D7Y1B			16.7	-	20	-	13.9	0.6	1.3	0.3 x3
FCAG100BVEB	x2 RZA200D7Y1B			16.4	-	20	-	13.1	0.6	1.3	0.7 x2
FFA50A2VEB	x4 RZA200D7Y1B			16.5	-	20	-	13.0	0.6	1.3	0.4 x4
FFA60A2VEB	x3 RZA200D7Y1B			17.7	-	20	-	13.9	0.6	1.3	0.6 x3
FBA50A2VEB	x4 RZA200D7Y1B			(14.9)*	-	20	-	13.0	0.6	1.3	1.4 x4
FBA60A2VEB	x3 RZA200D7Y1B			(15.8)*	-	20	-	13.9	0.6	1.3	1.3 x3
FBA71A2VEB	x3 RZA200D7Y1B			(15.8)*	-	20	-	13.9	0.6	1.3	1.3 x3
FBA100A2VEB	x2 RZA200D7Y1B			(15.0)*	-	20	-	13.1	0.6	1.3	3.5 x2
FHA50AVEB	x4 RZA200D7Y1B			17.4	-	20	-	13.0	0.6	1.3	0.6 x4
FHA60AVEB	x3 RZA200D7Y1B			17.7	-	20	-	13.9	0.6	1.3	0.6 x3
FHA71AVEB	x3 RZA200D7Y1B			18.3	-	20	-	13.9	0.6	1.3	0.8 x3
FHA100AVEB	x2 RZA200D7Y1B			17.7	-	20	-	13.1	0.6	1.3	1.3 x2
FUA71AVEB	x3 RZA200D7Y1B			18.6	-	20	-	13.9	0.6	1.3	0.9 x3
FUA100AVEB	x2 RZA200D7Y1B			17.7	-	20	-	13.1	0.6	1.3	1.3 x2
FAA71BUV1B	x3 RZA200D7Y1B			17.4	-	20	-	13.9	0.6	1.3	0.5 x3
FAA100BUV1B	x2 RZA200D7Y1B			16.8	-	20	-	13.1	0.6	1.3	0.9 x2
FVA71AMVEB	x3 RZA200D7Y1B			18.3	-	20	-	13.9	0.6	1.3	0.8 x3
FVA100AMVEB	x2 RZA200D7Y1B			18.1	-	20	-	13.1	0.6	1.3	1.5 x2
FDXM50F3V1B	x4 RZA200D7Y1B			18.6	-	20	-	13.0	0.6	1.3	0.9 x4
FDXM60F3V1B	x3 RZA200D7Y1B			18.6	-	20	-	13.9	0.6	1.3	0.9 x3
FNA50A2VEB	x4 RZA200D7Y1B			17.0	-	20	-	13.0	0.6	1.3	0.5 x4
FNA60A2VEB	x3 RZA200D7Y1B			17.7	-	20	-	13.9	0.6	1.3	0.6 x3
FDA250A2VEB	RZA250D7Y1B			(15.9)*	-	20	-	14.0	0.6	1.3	4.3
FCAG60BVEB	x4 RZA250D7Y1B			17.2	-	20	-	14.0	0.6	1.3	0.3 x4
FCAG125BVEB	x2 RZA250D7Y1B			18.2	-	20	-	13.6	0.6	1.3	1.3 x2
FFA60A2VEB	x4 RZA250D7Y1B			18.4	-	20	-	14.0	0.6	1.3	0.6 x4
FBA60A2VEB	x4 RZA250D7Y1B			(15.9)*	-	20	-	14.0	0.6	1.3	1.3 x4
FBA125A2VEB	x2 RZA250D7Y1B			(15.5)*	-	20	-	13.6	0.6	1.3	3.6 x2
FHA60AVEB	x4 RZA250D7Y1B			18.4	-	20	-	14.0	0.6	1.3	0.6 x4
FHA125AVEB	x2 RZA250D7Y1B	18.6	-	20	-	13.6	0.6	1.3	1.5 x2		
FUA125AVEB	x2 RZA250D7Y1B	18.4	-	20	-	13.6	0.6	1.3	1.4 x2		
FDA125A5VEB	x2 RZA250D7Y1B	19.9	-	20	-	13.6	0.6	1.3	2.1 x2		
FVA125AMVEB	x2 RZA250D7Y1B	18.6	-	20	-	13.6	0.6	1.3	1.5 x2		
FDXM60F3V1B	x4 RZA250D7Y1B	19.7	-	20	-	14.0	0.6	1.3	0.9 x4		
FNA60A2VEB	x4 RZA250D7Y1B	18.4	-	20	-	14.0	0.6	1.3	0.6 x4		

\* Use a separate power supply for the indoor unit. The value between brackets is the MCA of the outdoor unit. For the MCA of the indoor unit, see the installation manual of the indoor unit.

RZA-D

3D125194B

RZA-D

Symbols	Notes
MCA Minimum Circuit Ampere [A]	<p>1 The -RLA- is based on the following conditions.</p> <p>Cooling Indoor temperature -27.0°C DB / -19.0°C WB Outdoor temperature -35.0°C DB</p> <p>Heating Indoor temperature -20.0°C DB Outdoor temperature -7.0°C DB / -6.0°C WB</p> <p>2 -TOCA- is the total value of each overcurrent set.</p> <p>3 Voltage range The units are suitable for use with electrical systems in which the voltage supplied to the unit terminals is not below or above the listed range limits.</p> <p>4 The maximum allowable voltage that is unbalanced between phases is -2%.</p> <p>5 -MCA- is the maximum input current. The capacity of the -MFA- must be greater than that of the -MCA-.</p> <p>6 Select the wire size according to the MCA.</p> <p>7 -MFA- is used to select the circuit breaker and the ground fault circuit interruptor. Earth leakage circuit breaker</p>
TOCA Total overcurrent amps [A]	
MFA Maximum Fuse Ampere [A]	
MSC Maximum current of the starting compressor [A]	
RLA Rated load amps [A]	
OFM Outdoor fan motor	
IFM Indoor fan motor	
FLA Full Load Ampere [A]	
KW Fan motor rated output [kW]	

3D125194B



## Detailed technical drawings

### RZA-D

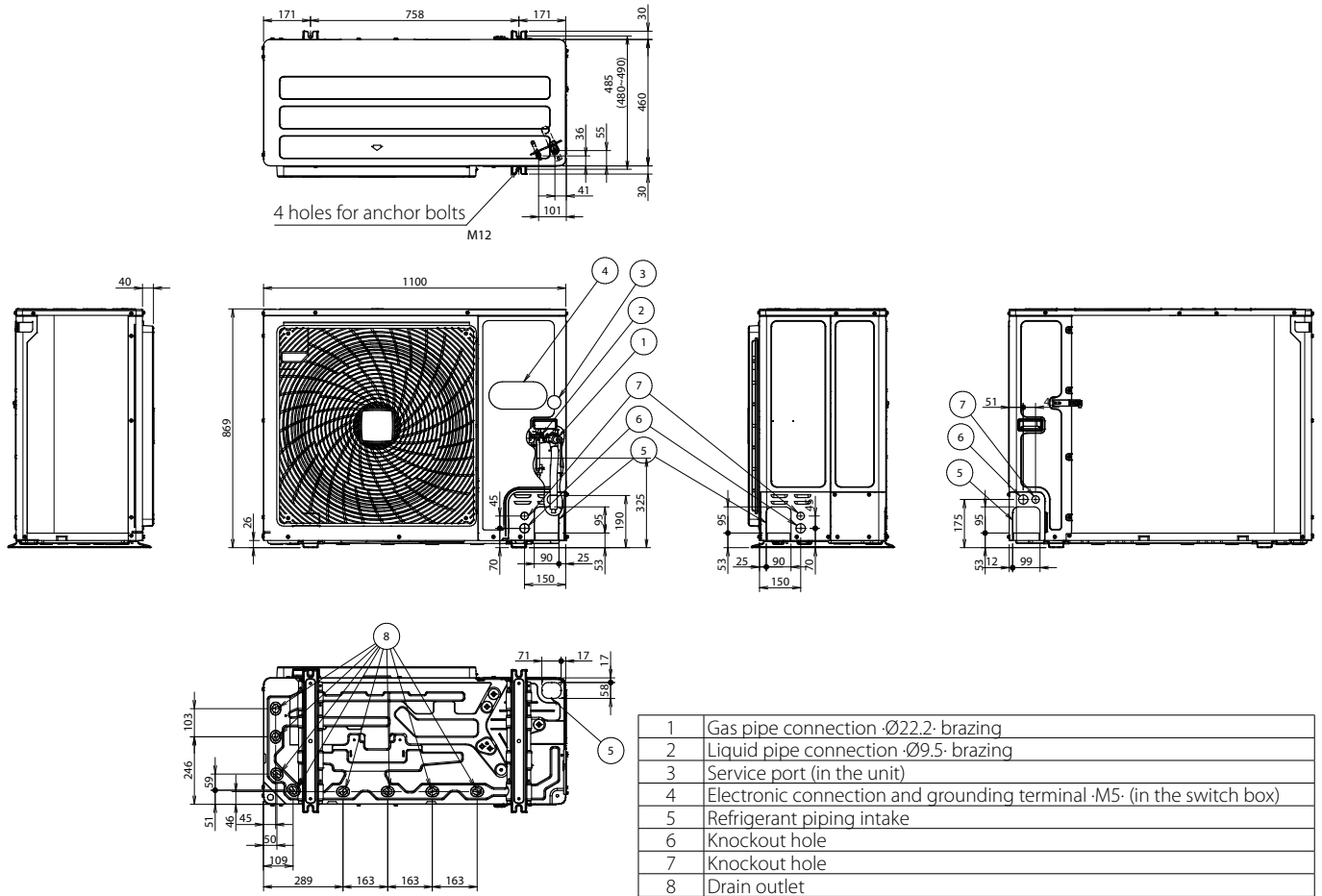

3D120937

### RZAG-NV1/NY1 RZA-D

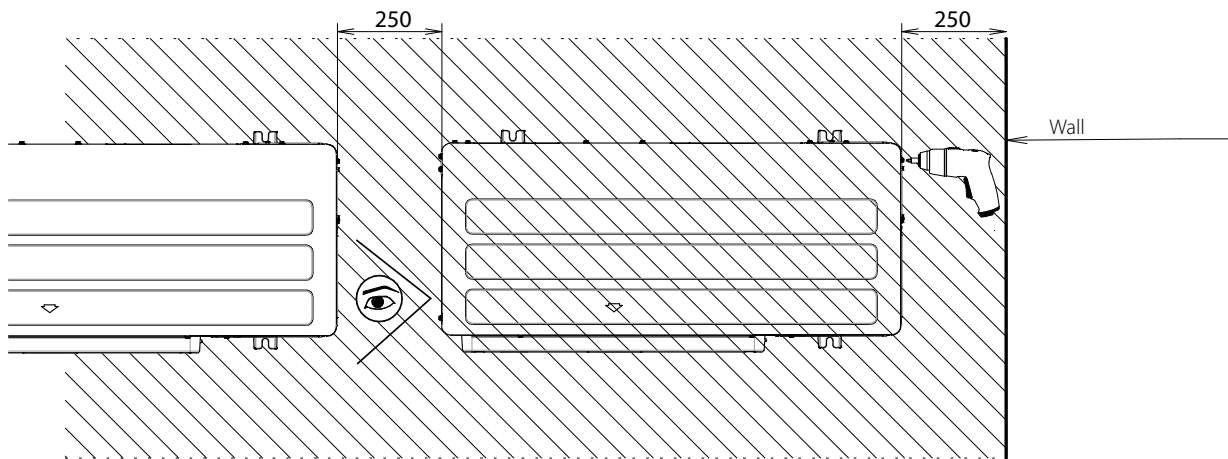

\* For optimal serviceability, provide ·250-mm of free space.  
For more installation and service space guidelines, see drawing ·3D069554·.

3D110012

**RZAG-NV1/NY1  
RZA-D**

<b>Suction side</b>	In the illustrations below, the service space at the suction side is based on 35°C DB and cooling operation. Foresee more space in the following cases: • When the suction side temperature regularly exceeds this temperature. • When the heat load of the outdoor units is expected to regularly exceed the maximum operating capacity.
<b>Discharge side</b>	Take refrigerant piping work into account when positioning the units. If your layout does not match with any of the layouts below, contact your dealer.

Single unit | Single row of units

A~E	$H_b, H_D, H_U$	(mm)								
		a	b	c	d	e	$e_b$	$e_D$		
B	—		≥100							
A, B, C	—	≥100 <sup>(1)</sup>	≥100	≥100						
B, E	—		≥100			≥1000			≤500	
A, B, C, E	—	≥150 <sup>(1)</sup>	≥150	≥150		≥1000			≤500	
D	—				≥500					
D, E	—				≥500	≥1000	≥500			
B, D	$H_D > H_U$		≥100		≥500					
	$H_D < H_U$		≥100		≥500					
B, D, E	$H_D > H_U$	$H_b \leq \frac{1}{2}H_U$	≥250		≥750	≥1000	≤500			1
		$\frac{1}{2}H_U < H_b \leq H_U$	≥250		≥1000	≥1000	≤500			
	$H_b > H_U$	⊘								
	$H_D \leq H_U$	$H_b \leq \frac{1}{2}H_U$	≥100		≥1000	≥1000		≤500		
$\frac{1}{2}H_U < H_b \leq H_U$		≥200		≥1000	≥1000		≤500			
$H_D > H_U$	⊘									
	$H_D > H_U$	⊘								
A, B, C	—	≥200 <sup>(1)</sup>	≥300	≥1000						
A, B, C, E	—	≥200 <sup>(1)</sup>	≥300	≥1000		≥1000			≤500	
D	—				≥1000					
D, E	—				≥1000	≥1000	≤500			
B, D	$H_D > H_U$		≥300		≥1000					
	$H_D \leq H_U$	$H_b \leq \frac{1}{2}H_U$	≥250		≥1500					
$\frac{1}{2}H_U < H_b \leq H_U$		≥300		≥1500						
B, D, E	$H_D > H_U$	$H_b \leq \frac{1}{2}H_U$	≥300		≥1000	≥1000	≤500			1+2
		$\frac{1}{2}H_U < H_b \leq H_U$	≥300		≥1250	≥1000	≤500			
	$H_b > H_U$	⊘								
	$H_D \leq H_U$	$H_b \leq \frac{1}{2}H_U$	≥250		≥1500	≥1000		≤500		
$\frac{1}{2}H_U < H_b \leq H_U$		≥300		≥1500	≥1000		≤500			
$H_D > H_U$	⊘									
	$H_D > H_U$	⊘								

(1) For better serviceability, use a distance ≥250 mm

**A, B, C, D** Obstacles (walls/baffle plates)

**E** Obstacle (roof)

**a, b, c, d, e** Minimum service space between the unit and obstacles A, B, C, D and E

**eB** Maximum distance between the unit and the edge of obstacle E, in the direction of obstacle B

**eD** Maximum distance between the unit and the edge of obstacle E, in the direction of obstacle D

**H<sub>U</sub>** Height of the unit

**H<sub>B</sub>, H<sub>D</sub>** Height of obstacles B and D

1 Seal the bottom of the installation frame to prevent discharged air from flowing back to the suction side through the bottom of the unit.

2 Maximum two units can be installed.

⊘ Not allowed

Detailed technical drawings

**RZAG-NV1/NY1**  
**RZA-D**

Multiple rows of units

$H_b, H_u$	$b$ (mm)
$H_b \leq \frac{1}{2}H_u$	$b \geq 250$
$\frac{1}{2}H_u < H_b \leq H_u$	$b \geq 300$
$H_b > H_u$	⊘

(1) For better serviceability, use a distance  $\geq 250$  mm

Stacked units (max. 2 levels)

(1) For better serviceability, use a distance  $\geq 250$  mm

**A1=>A2** (A1) If there is danger of drainage dripping and freezing between the upper and lower units...

(A2) Then install a roof between the upper and lower units. Install the upper unit high enough above the lower unit to prevent ice buildup at the upper unit's bottom plate.

**B1=>B2** (B1) If there is no danger of drainage dripping and freezing between the upper and lower units...

(B2) Then it is not required to install a roof, but seal the gap between the upper and lower units to prevent discharged air from flowing back to the suction side through the bottom of the unit.

## RZA-D

### To determine the additional refrigerant amount

To determine if adding additional refrigerant is necessary

Chargeless length	
Ø standard	30 m
Ø size-up of <b>gas</b> piping	30 m
Ø size-up of <b>liquid</b> piping	20 m

If	Then
$(L1+L2+L3+L4+L5+L6+L7) \leq$ chargeless length	You do not have to add additional refrigerant.
$(L1+L2+L3+L4+L5+L6+L7) >$ chargeless length	You must add additional refrigerant. For future servicing, encircle theselected amount in the tables below.

#### INFORMATION

Piping length is the largest one-way length of liquid piping.

To determine the additional refrigerant amount (R in kg) (in case of pair)

Standard piping size:

		L1 (m)						
<b>L1:</b>		30~40 m	40~50 m	50~60 m	60~70 m	70~80 m	80~90 m	90~100 m
<b>R:</b>		0.45 kg	0.9 kg	1.35 kg	1.8 kg	2.25 kg	2.7 kg	3.15 kg

Size-up piping size:

		L1 (m)					
<b>L1:</b>		20~25 m	25~30 m	30~35 m	35~40 m	40~45 m	40~45m
<b>R:</b>		0.35 kg	0.7 kg	1.05 kg <sup>(a)</sup>	1.4 kg <sup>(a)</sup>	1.75 kg	2.1 kg

To determine the additional refrigerant amount (R in kg) (in case of twin, triple and double twin)

1. Determine G1 and G2.

G1 (m)	Total length of <x> liquid piping x=Ø9.5 mm (standard) x=Ø12.7 mm (size-up)
G2 (m)	Total length of Ø6.4 mm liquid piping

2. Determine R1 and R2.

If	Then
$G1 > 30$ m <sup>(a)</sup>	Use the table below to determine R1 (length=G1-30 m) <sup>(a)</sup> and R2 (length=G2).
$G1 \leq 30$ m <sup>(a)</sup> (and $G1+G2 > 30$ m) <sup>(a)</sup>	R1=0.0 kg. Use the table below to determine R2 (length=G1+G2-30 m) <sup>(a)</sup> .

(a) In case of size-up: replace 30 m by 20 m.

Standard liquid pipe size							
	Length (m)						
	0~10 m	10~20 m	20~30 m	30~40 m	40~50 m	50~60 m	60~70 m
<b>R1:</b>	0.45 kg	0.9 kg	1.35 kg	1.8 kg	2.25 kg	2.7 kg	3.15 kg
<b>R2:</b>	0.2 kg	0.4 kg	0.6 kg	0.8 kg	1 kg	1.2 kg	1.4 kg

Size-up liquid pipe size							
	Length (m)						
	0~5 m	5~10 m	10~15 m	15~20 m	20~25 m	25~30 m	
<b>R1:</b>	0.35 kg	0.7 kg	1.05 kg	1.1 kg	1.75 kg	2.1 kg	
<b>R2:</b>	0.18 kg	0.35 kg	0.53 kg	0.7 kg	0.88 kg	1.05 kg	

3. Determine the additional refrigerant amount: R=R1+R2.

Examples

Layout	Additional refrigerant amount (R)	
	Case: Twin, standard liquid pipe size	
	1.	G1 Total Ø9.5 => G1=35+7+5=47 m G2 Total Ø6.4 => G2=0 m
	2.	Case: G1>30 m R1 Length=G1-30 m=47-30 m=> R1=0.9 kg R2 Length=G2=0 m => R2=0 kg
	Case: Triple, standard liquid pipe size	
	1.	G1 Total Ø9.5 => G1=5 m G2 Total Ø6.4 => G2=10+17+17=44 m
	2.	Case: G1≤30 m (and G1+G2>30 m) R1 R1=0.0 kg R2 Length=G1+G2-30=5+44-30=19 m => R2=0.4 kg
	3.	R R=R1+R2=0+0.4=0.4 kg



## AZAS71-140MV1

Indoor	Outdoor	Power supply	Voltage range		MCA		TOCA		MFA		Compressor		OFM		IFM	
					MCA	TOCA	MFA	MSC	RLA	kW	FLA	kW	FLA			
FCAG71BVEB	AZAS71M2V1B	50Hz~ 220- 240 V	Minimum: 198 V	Maximum: 264 V	17.4	-	20	-	15.4	0.094	0.9	0.054	0.4			
FBA71A2VEB	AZAS71M2V1B				17.5	-	20	-	15.4	0.094	0.9	0.070	0.5			
FAA71BUV1B	AZAS71M2V1B				17.4	-	20	-	15.4	0.094	0.9	0.048	0.4			
ADEA71A2VEB	AZAS71M2V1B				17.5	-	20	-	15.4	0.094	0.9	0.070	0.5			
FCAG100BVEB	AZAS100M7V1B				21.5	-	25	-	19.0	0.200	1.0	0.117	0.7			
FBA100A2VEB	AZAS100M7V1B				21.8	-	25	-	19.0	0.200	1.0	0.127	1.0			
FAA100BUV1B	AZAS100M7V1B				21.7	-	25	-	19.0	0.200	1.0	0.064	0.9			
ADEA100A2VEB	AZAS100M7V1B				21.8	-	25	-	19.0	0.200	1.0	0.127	1.0			
FCAG125BVEB	AZAS125M7V1B				27.8	-	32	-	24.7	0.200	1.0	0.168	1.0			
FBA125A2VEB	AZAS125M7V1B				28.3	-	32	-	24.7	0.200	1.0	0.187	1.5			
ADEA125A2VEB	AZAS125M7V1B				28.3	-	32	-	24.7	0.200	1.0	0.187	1.5			
FCAG140BVEB	AZAS140M7V1B				27.0	-	32	-	24.0	0.200	1.0	0.168	1.0			
FBA140A2VEB	AZAS140M7V1B				27.6	-	32	-	24.0	0.200	1.0	0.187	1.5			
FCAG100BVEB	AZAS100M7Y1B				3N~50 Hz 380- 415 V	Minimum: 342 V	Maximum: 456 V	14.2	-	16	-	12.0	0.200	1.0	0.117	0.7
FBA100A2VEB	AZAS100M7Y1B							14.6	-	16	-	12.0	0.200	1.0	0.127	1.0
FAA100BUV1B	AZAS100M7Y1B							14.4	-	16	-	12.0	0.200	1.0	0.064	0.9
FCAG125BVEB	AZAS125M7Y1B	14.6	-	16				-	12.0	0.200	1.0	0.168	1.0			
FBA125A2VEB	AZAS125M7Y1B	15.1	-	16				-	12.0	0.200	1.0	0.187	1.5			
FCAG140BVEB	AZAS140M7Y1B	14.6	-	16				-	12.0	0.200	1.0	0.168	1.0			
FBA140A2VEB	AZAS125M7Y1B	15.1	-	16				-	12.0	0.200	1.0	0.187	1.5			

AZAS71-140MV1

3D110014G

## AZAS-MV1/MY1

Symbols	Notes
<p>MCA Min. Circuit Amps. (A)</p> <p>TOCA Total Over-Current Amps. (A)</p> <p>MFA Max. Fuse Amps (See note 7) (A)</p> <p>MSC Max. current during the starting compressor. (A)</p> <p>RLA Rated Load Amps. (A)</p> <p>OFM Outdoor Fan Motor. (A)</p> <p>IFM Indoor Fan Motor.</p> <p>FLA Full Load Amps.</p> <p>kW Fan Motor Rated Output (kW)</p>	<p>1 RLA is based on the following indoor conditions: Cooling Indoor temperature 27.0°CDB/19.0°CWB Outdoor temperature 35.0°CDB Heating Indoor temperature 20.0°CDB Outdoor temperature 7.0°CDB/6.0°CWB.</p> <p>2 TOCA is the total value of each overcurrent set.</p> <p>3 Voltage range The units are suitable for use with electrical systems in which the voltage supplied to the unit terminals is not below or above the listed range limits.</p> <p>4 Maximum allowable voltage variation between phases is 2% .</p> <p>5 MCA is the maximum input current. The capacity of the MFA must be greater than that of the MCA. Select the MFA according to the table.</p> <p>6 Select the wire size according to the MCA.</p> <p>7 MFA is used to select the circuit breaker and the ground fault circuit interrupter. Earth leakage circuit breaker</p>

3D110014G





## AZAS71MV1

4 holes for anchor bolts  
M12

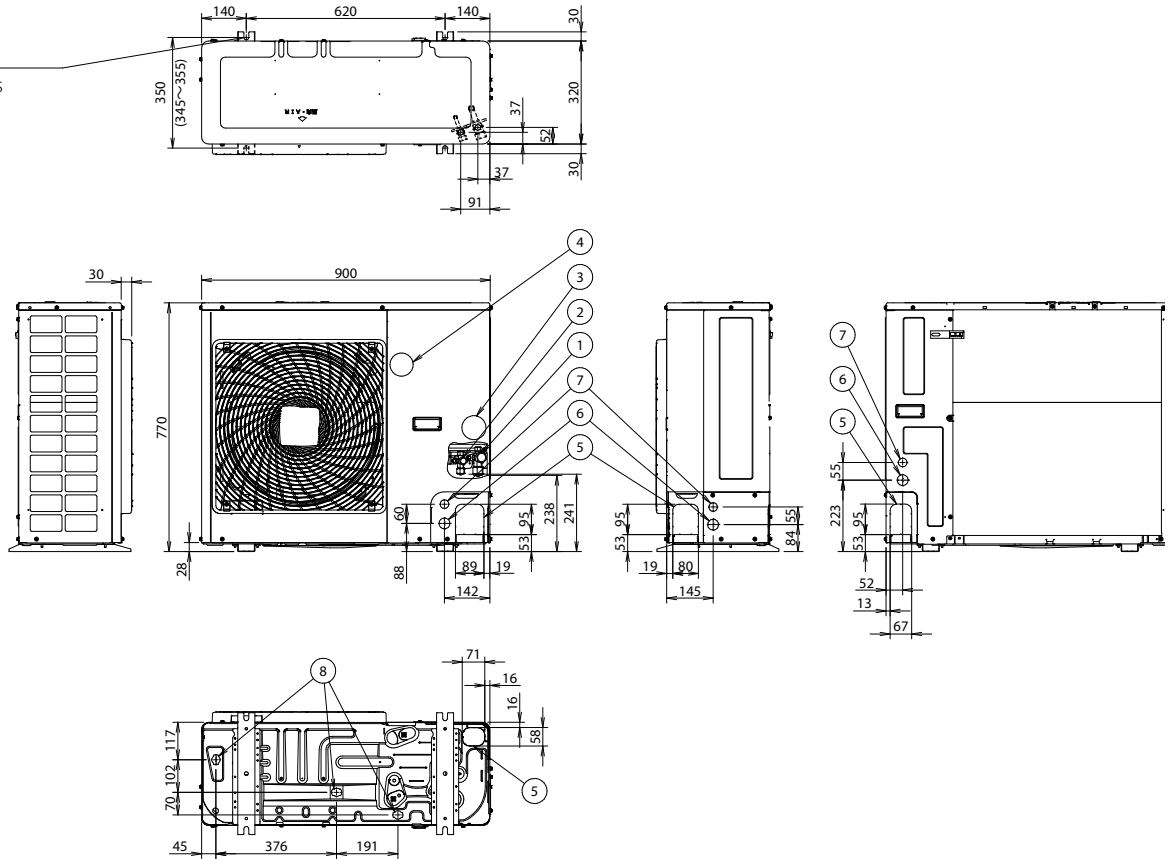

1	Gas pipe connection ·Ø15.9· flare
2	Liquid pipe connection ·Ø9.5· flare
3	Service port (in the unit)
4	Electronic connection and grounding terminal ·M5· (in the switch box)
5	Refrigerant piping intake
6	Power supply wiring intake (knockout hole Ø34)
7	Control wiring intake (knockout hole Ø27)
8	Drain outlet

**3D110013**



## Detailed technical drawings

### AZAS100-140MV1/MY1

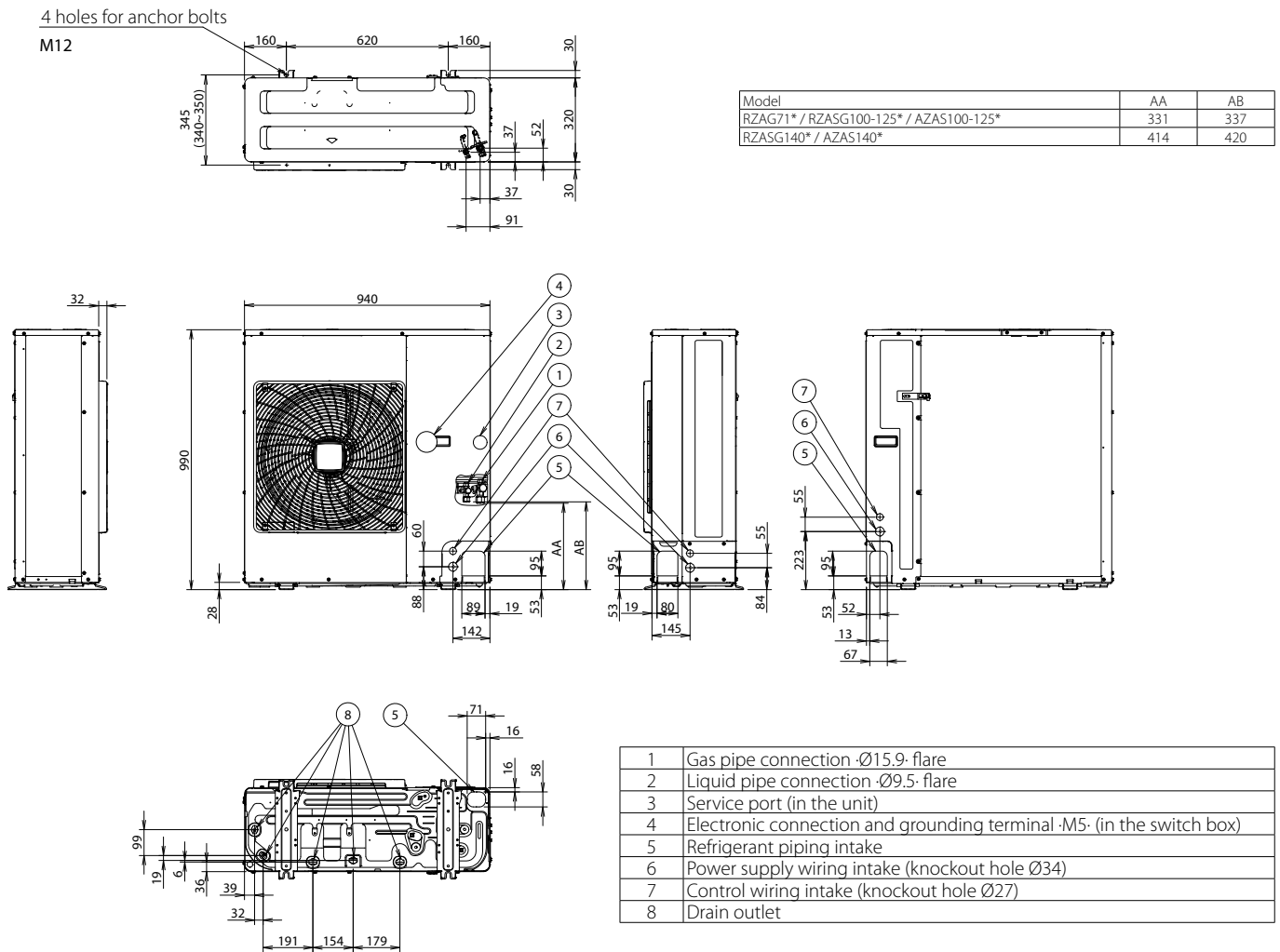

3D110011



## AZAS-MV1/MY1

### Installation service space

The measure of these values is "mm".

#### (A) When there are obstacles on suction sides.

##### • No obstacle above

(1) Stand-alone installation

- Obstacle on the suction side only

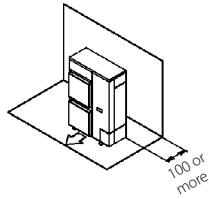

- Obstacle on both sides and suction side, too

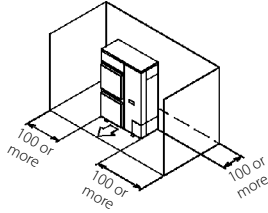

(2) Series installation (2 or more) (note 1)

- Obstacle on the suction side and both sides

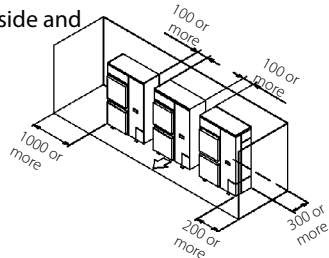

##### • Obstacle above, too

(1) Stand-alone installation

- Obstacle on the suction side, too

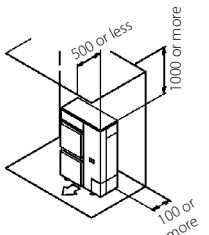

- Obstacle on both sides and suction side, too

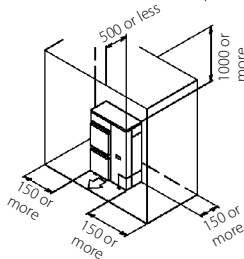

(2) Series installation (2 or more) (note 1)

- Obstacle on the suction side and both sides

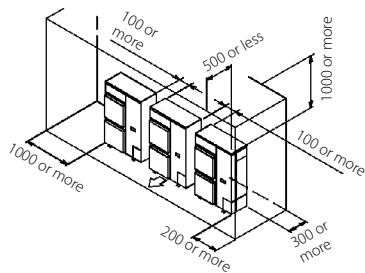

#### (B) When there are obstacles on discharge sides.

##### • No obstacle above

(1) Stand-alone installation

- Obstacle on the discharge side only

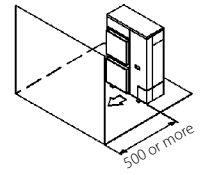

(2) Series installation (2 or more) (note 1)

- Obstacle on the suction side only

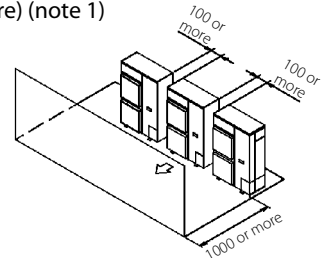

##### • Obstacle above, too

(1) Stand-alone installation

- Obstacle on the discharge side only, too

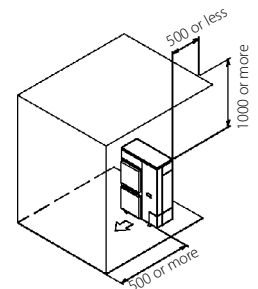

(2) Series installation (2 or more) (note 1)

- Obstacle on discharge side

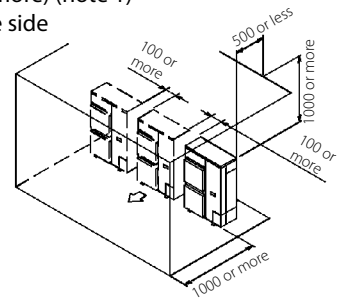

#### (C) When there are obstacles on both suction and discharge sides:

##### Pattern 1

When the obstacles on the discharge side is higher than the unit. (L > H)

(There is no limit for the height of obstructions on the suction side.)

##### • No obstacle above

(1) Stand-alone installation

- No obstacle above

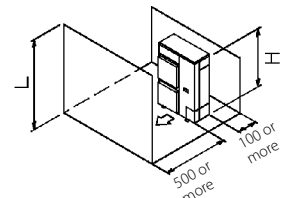

(2) Series installation (2 or more) (note 1)

- No obstacle above

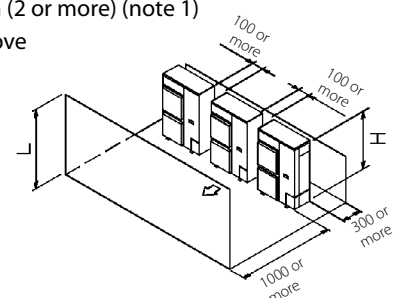

3D069554

**AZAS-MV1/MY1**

**• Obstacle above, too**

(1) Stand-alone installation (note 2)

- When there are obstacles on suction, discharge and top sides.

The relations between H, A and L are as follows:

	L	A
$L \leq H$	$L \leq 1/2H$	750 or more
	$1/2H < L \leq H$	1000 or more
$H < L$	Set the stand as: $L \leq H$ Refer to the column of $L \leq H$ for A	

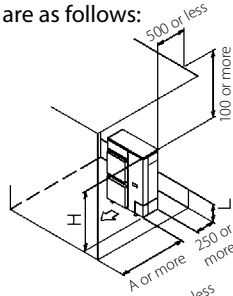

(2) Series installation (2 or more) (note 1,2)

- When there are obstacles on suction, discharge and top sides.
- The relations between H, A and L are as follows:

	L	A
$L \leq H$	$L \leq 1/2H$	1000 or more
	$1/2H < L \leq H$	1250 or more
$H < L$	Set the stand as: $L \leq H$ Refer to the column of $L \leq H$ for A	

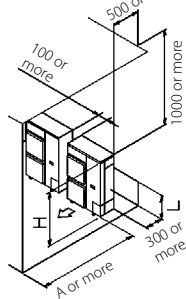

Limit of series installation is 2 units.

**Pattern 2**

When the obstacle on the discharge side is lower than the unit ( $L \leq H$ )

(There is no limit for the height of obstructions on the suction side.)

**• No obstacle above**

(1) Stand-alone installation

- No obstacle above

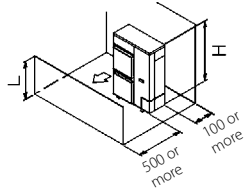

(2) Series installation (2 or more) (note 1, 2)

- When there are obstacles on both suction and discharge sides.

The relations between H, A and L are as follows.

	L	A
$L \leq H$	$L \leq 1/2H$	250 or more
	$1/2H < L \leq H$	300 or more

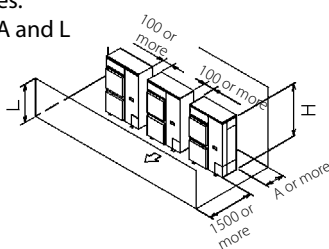

**• Obstacle above**

(1) Stand-alone installation (note 2)

- When there are obstacles on suction, discharge and top sides.

The relations between H, A and L are as follows.

	L	A
$L \leq H$	$L \leq 1/2H$	100 or more
	$1/2H < L \leq H$	200 or more
$H < L$	Set the stand as: $L \leq H$ Refer to the column of $L \leq H$ for A	

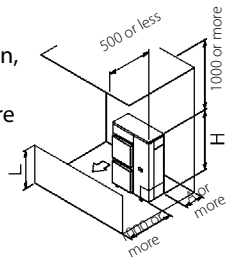

(2) Series installation (2 or more) (note 1,2)

- When there are obstacles on suction, discharge and top sides.
- The relations between H, A and L are as follows.

	L	A
$L \leq H$	$L \leq 1/2H$	250 or more
	$1/2H < L \leq H$	300 or more
$H < L$	Set the stand as: $L \leq H$ Refer to the column of $L \leq H$ for A	

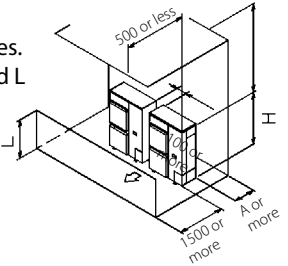

Limit of series installation is 2 units.

**(D) Double-decker installation**

(1) Obstacle on the discharge side. (1)

- Do not exceed two levels for stacked installation.
- Install a roof cover similar to A (field supply), as outdoor units with downward drainage are prone to dripping and freezing.
- Install the upper-level outdoor unit so that its bottom plate is a sufficient height above the roof cover. This is to prevent the buildup of ice on the underside of the bottom plate.

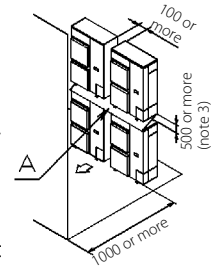

(2) Obstacle on the suction side. (1)

- Do not exceed two levels for stacked installation.
- Install a roof cover similar to A (field supply), as outdoor units with downward drainage are prone to dripping and freezing.
- Install the upper-level outdoor unit so that its bottom plate is a sufficient height above the roof cover. This is to prevent the buildup of ice on the underside of the bottom plate.

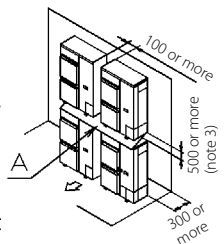

**(E) Multiple rows of series installation (on the rooftop, etc.)**

(1) One row of stand-alone installation

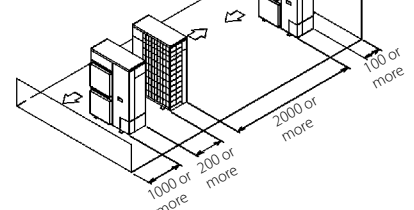

(2) Rows of series installation (2 or more)

The relations between H, A and L are as follows.

	L	A
$L \leq H$	$L \leq 1/2H$	1000 or more
	$1/2H < L \leq H$	1250 or more
$H < L$	Set the stand as: $L \leq H$ Refer to the column of $L \leq H$ for A	

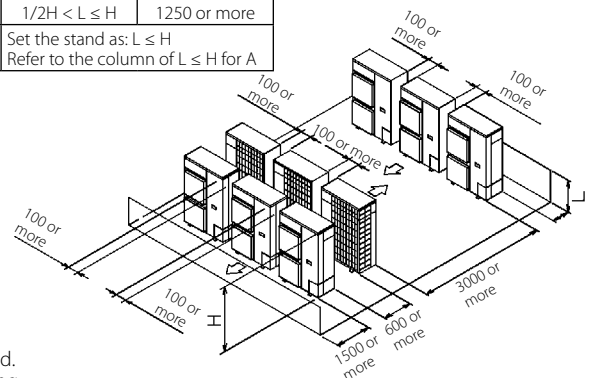

**NOTES**

1. In case of the sideways's piping, make a 100mm gap between the unit above.
2. Close the bottom of the installation frame to prevent the discharged air from being bypassed.
3. It is not necessary to install a roof cover if there is no danger of drainage dripping and freezing. In this case, the space between the upper and lower outdoor units should be at least 100mm. Close off the gap between the upper and lower units so there is no re intake of discharged air.



## AZAS-MV1/MY1

### To determine the complete recharge amount (kg)

Model	Lenght
AZAS71	5~30m
AZAS100- 125	2.45 Kg
AZAS140	2.6 Kg
	2.9 Kg

4PEN485929-1D\_2019\_04



Technical drawings  
Biddle air curtains



**CYQS\_M\_L-DK\_FBN\_FSN**

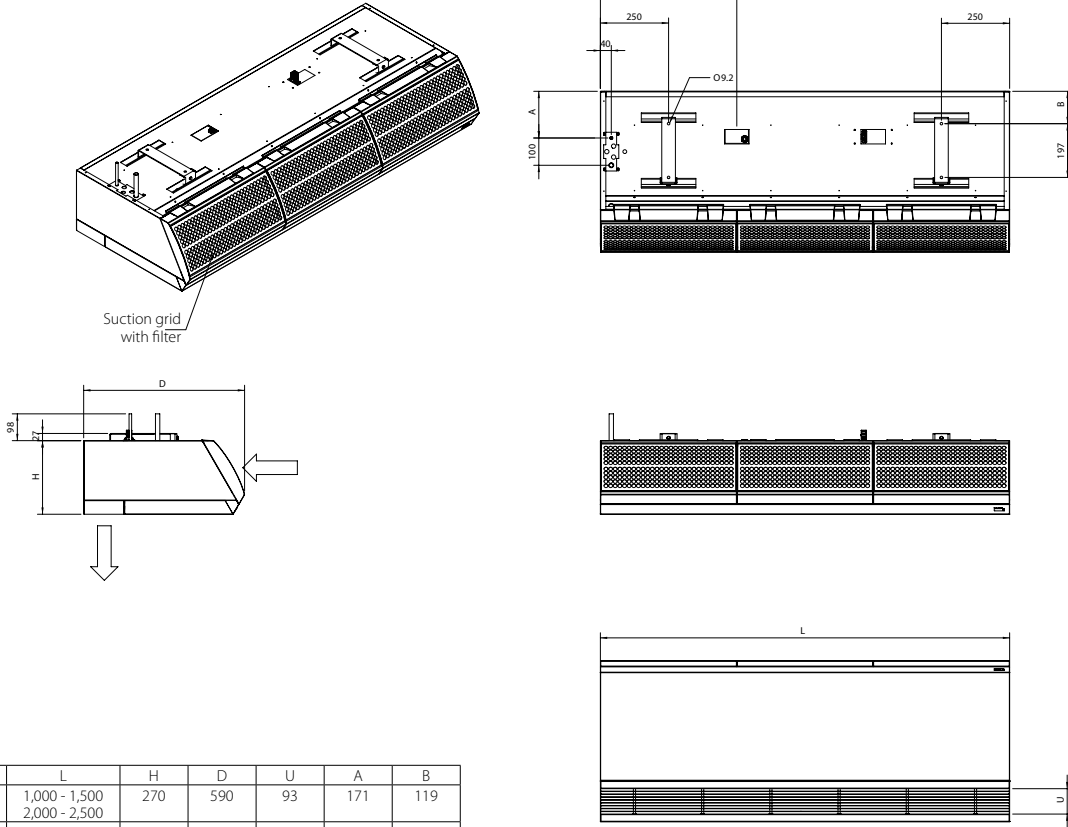

Type	L	H	D	U	A	B
CYQS-DK-FBN/FSN	1,000 - 1,500	270	590	93	171	119
CYQM-DK-FBN/FSN	2,000 - 2,500					
CYQL-DK-FBN/FSN	1,000 - 1,500	370	774	124.5	245.5	200
	2,000 - 2,500					

**NOTES**

1. The 2,500mm large devices have 3 suspension brackets, where the third bracket is mounted at half the length of the device.

**CU0954X-000**

**CYQS\_M\_L-DK\_CBN\_CSN**

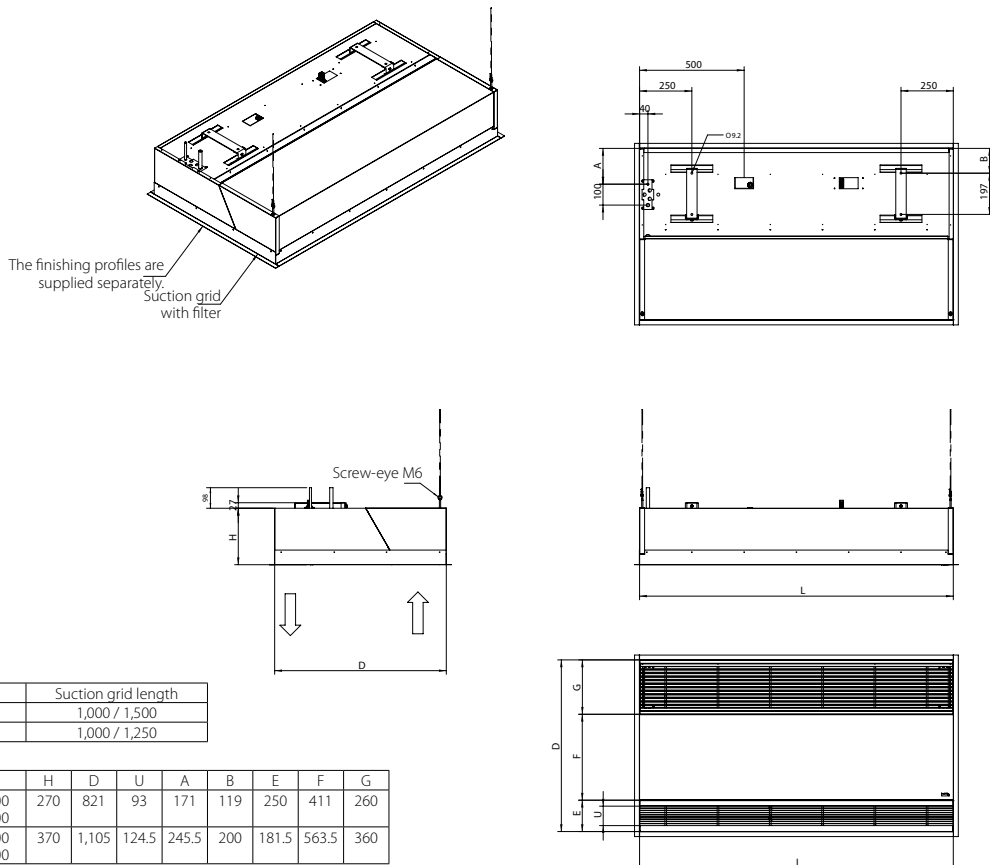

Number of suction grids per device

Device length	Number	Suction grid length
1000 / 1500	1	1,000 / 1,500
2000 / 2500	2	1,000 / 1,250

\*1 drain grid per device

Type	L	H	D	U	A	B	E	F	G
CYQS-DK-CBN/CSN	1,000 - 1,500	270	821	93	171	119	250	411	260
CYQM-DK-CBN/CSN	2,000 - 2,500								
CYQL-DK-CBN/CSN	1,000 - 1,500	370	1,105	124.5	245.5	200	181.5	563.5	360
	2,000 - 2,500								

**NOTES**

1. The 2,500mm large devices have 3 suspension brackets, where the third bracket is mounted at half the length of the device.  
2. The mounting holes for finishing profiles in a lowered ceiling (L+8) x (D+8) mm

**CU0955X-000**



## Detailed technical drawings

### CYQS\_M\_L-DK\_RBN\_RSN

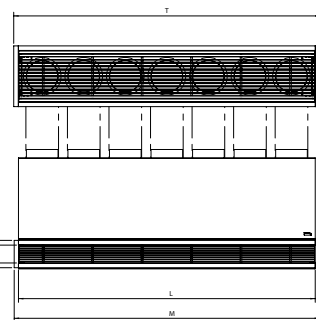
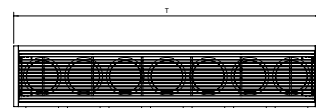
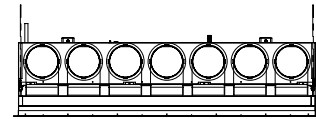
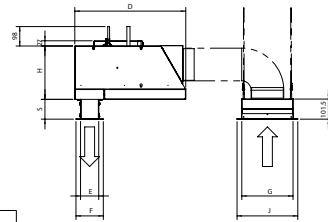
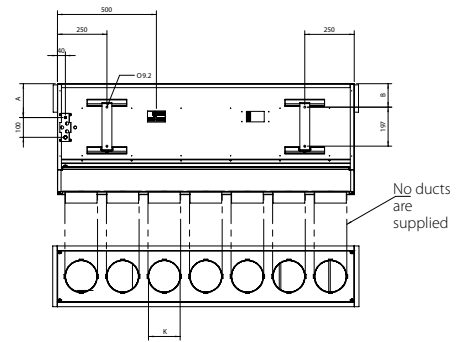
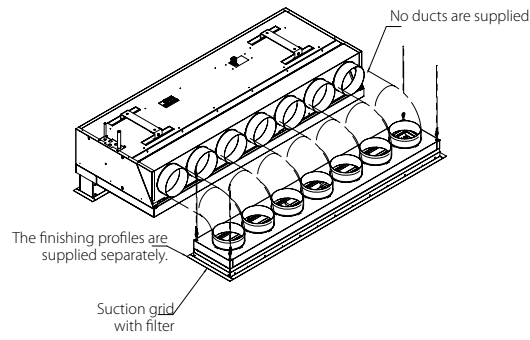

Number of ducts per device

Type	1000	1500	2000	2500
CYQS-DK-RBN/RSN	5	7	10	12
CYQM-DK-RBN/RSN				
CYQL-DK-RBN/RSN	3	5	6	8

Number of suction grids per device

Device length	Number	Suction grid length
1000 / 1500	1	1,000 / 1,500
2000 / 2500	2	1,000 / 1,250

\*1 drain grid per device

Type	L	H	D	S	U	A	B	E	F	G	J	K	M	T
CYQS-DK-RBN/RSN	1,000 - 1,500	270	561	80-125	90	171	119	92	139	260	308	Ø160	1044-1544	1048-1548
CYQM-DK-RBN/RSN	2,000 - 2,500												2044-2544	2048-2548
CYVL-DK-RBN/RSN	1,000 - 1,500	370	745	80-125	121.5	245.5	200	123.5	170	360	408	Ø250	1044-1544	1048-1548
	2,000 - 2,500												2044-2544	2048-2548

#### NOTES

- The 2,500mm large devices have 3 suspension brackets, where the third bracket is mounted at half the length of the device.
- Holes (for finishing profiles) - drain (L+8) x (E+8) mm - suction (L+8) x (G+8) mm.

**CU0956X-000**





# Technical drawings Ventilation

ALB-RBS/LBS

226

VAM-FC9/J8

232





Detailed technical drawings

**ALB06RBS/LBS**

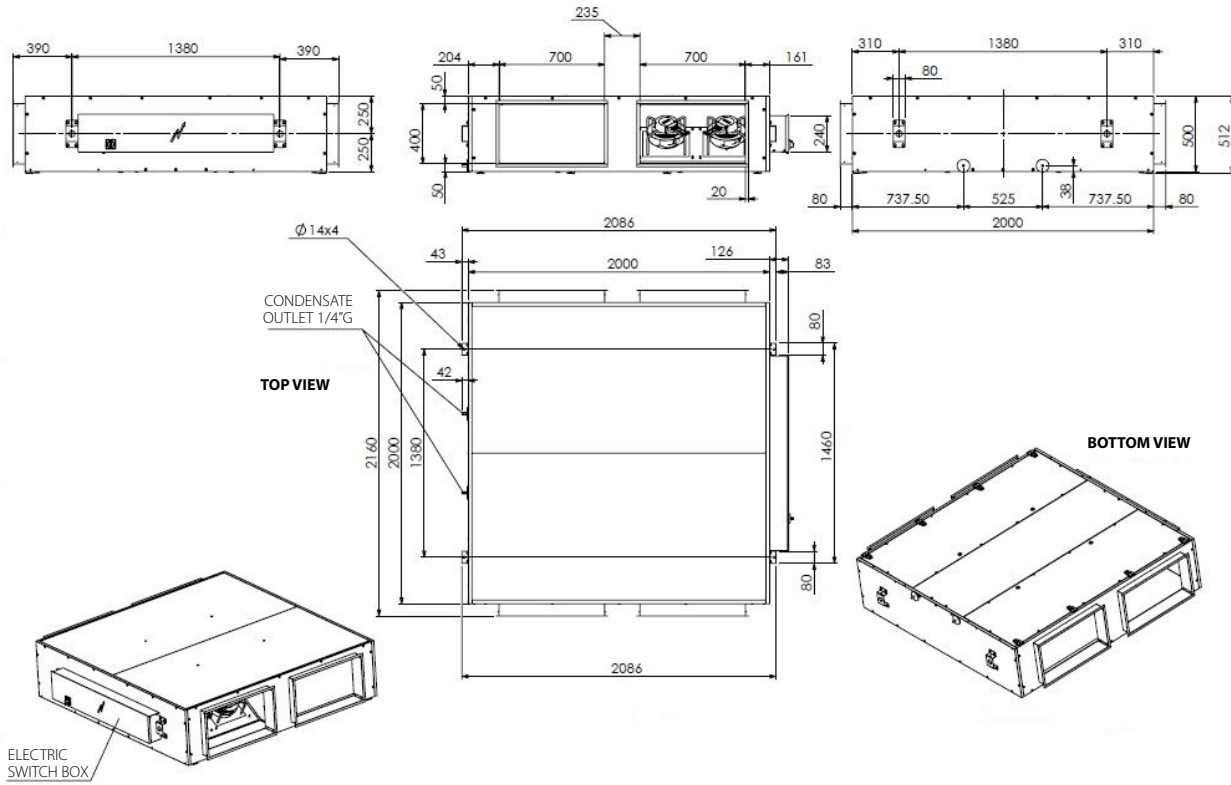

**ALB07RBS/LBS**

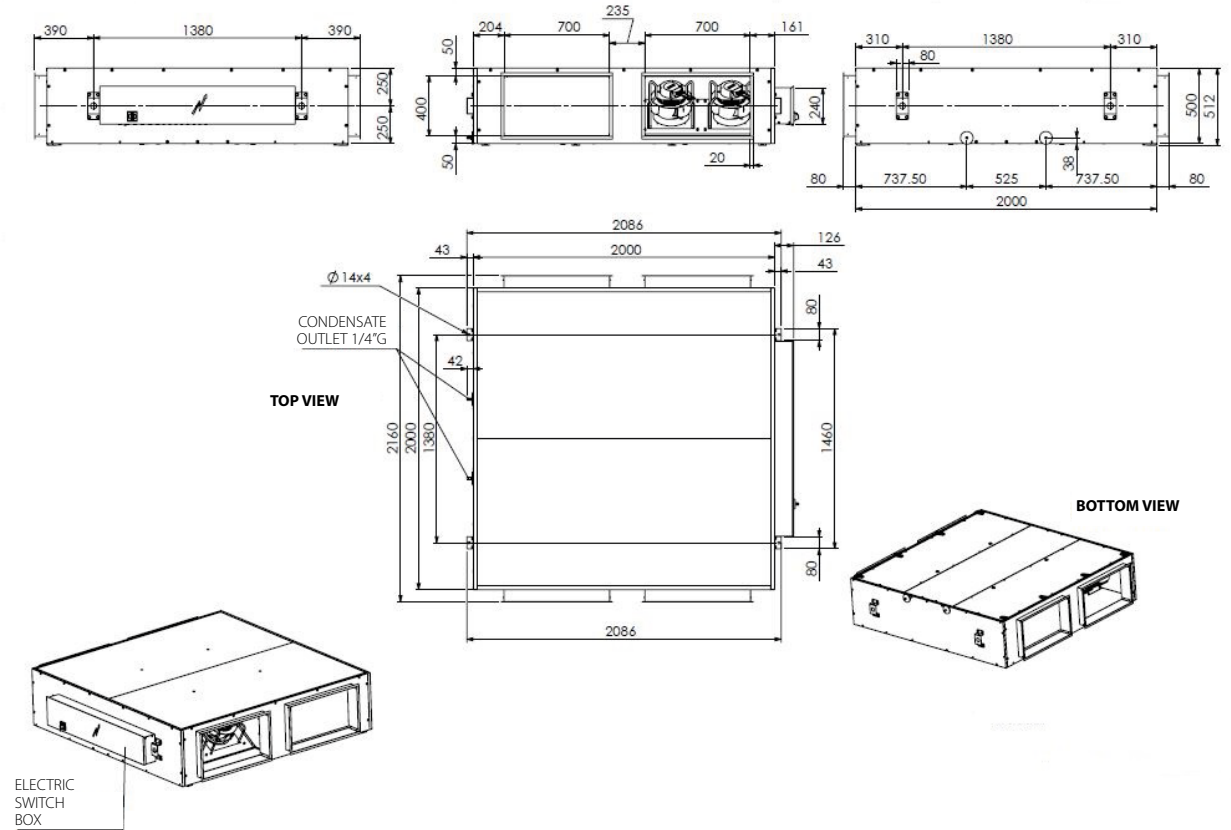



### ALB02RBS/LBS

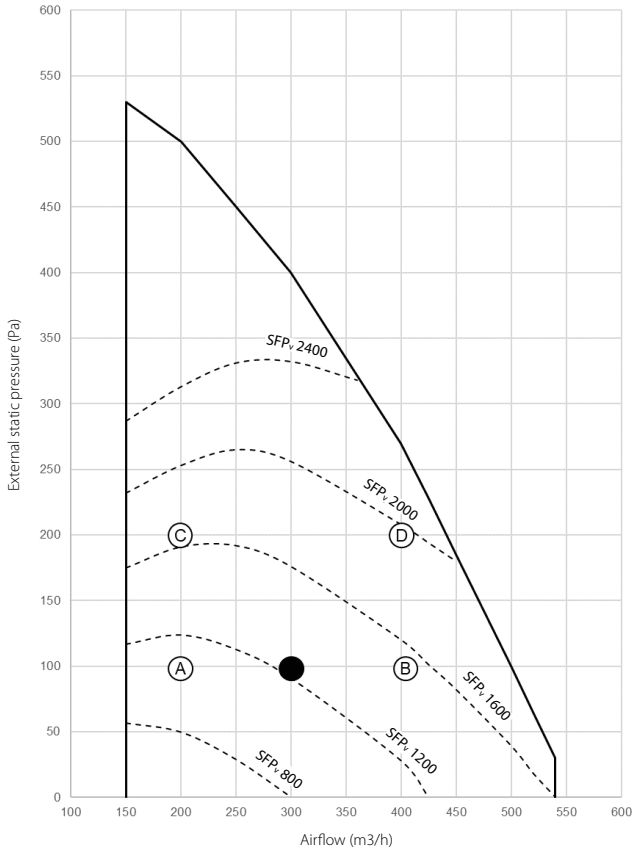

The diagram shows the available external pressure for the duct system given an airflow.

**SFP<sub>v</sub> = Specific Fan Power (W/m<sup>3</sup>/s)**

The SFP<sub>v</sub> curves are referring to the complete unit. Moreover, it includes power to both supply and extract fan divided by either the supply or extract volume whichever is the greater.

● Nominal working point

### ALB03RBS/LBS

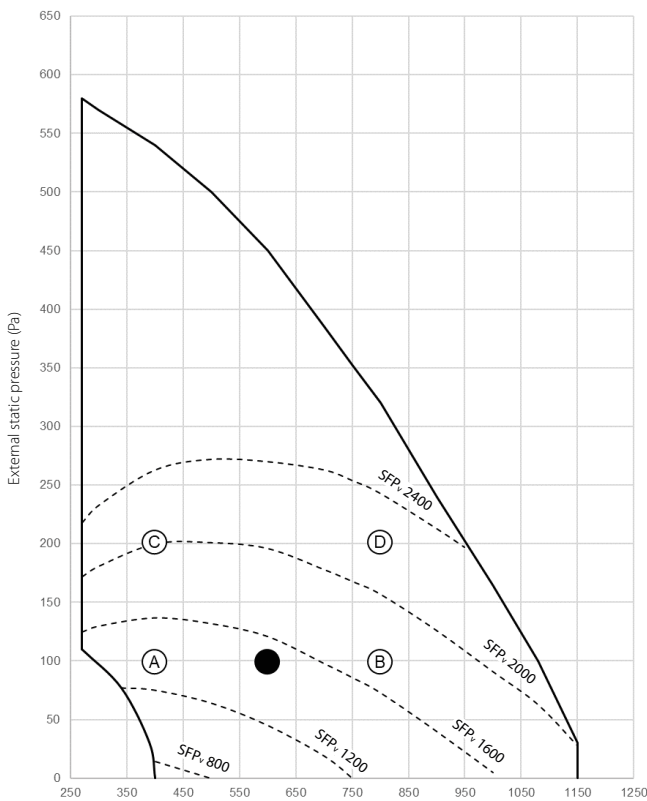

The diagram shows the available external pressure for the duct system given an airflow.

**SFP<sub>v</sub> = Specific Fan Power (W/m<sup>3</sup>/s)**

The SFP<sub>v</sub> curves are referring to the complete unit. Moreover, it includes power to both supply and extract fan divided by either the supply or extract volume whichever is the greater.

● Nominal working point



### ALB04RBS/LBS

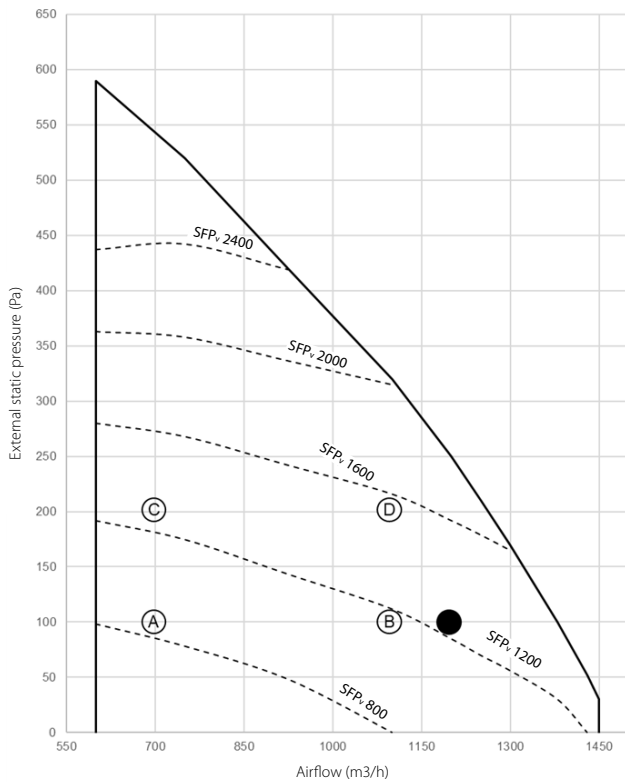

The diagram shows the available external pressure for the duct system given an airflow.

**SFPv = Specific Fan Power (W/m<sup>3</sup>/s)**

The SFPv curves are referring to the complete unit. Moreover, it includes power to both supply and extract fan divided by either the supply or extract volume whichever is the greater.

● Nominal working point

### ALB05RBS/LBS

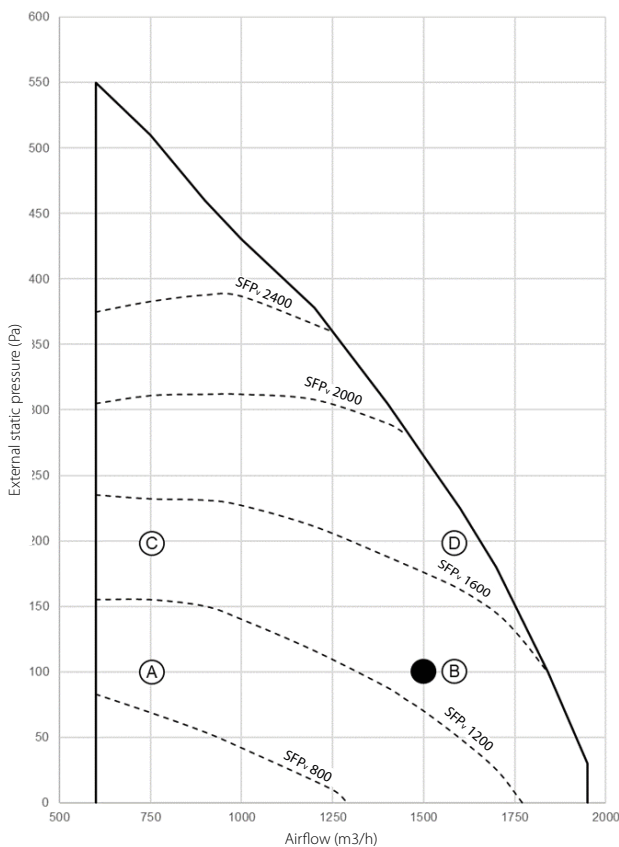

The diagram shows the available external pressure for the duct system given an airflow.

**SFPv = Specific Fan Power (W/m<sup>3</sup>/s)**

The SFPv curves are referring to the complete unit. Moreover, it includes power to both supply and extract fan divided by either the supply or extract volume whichever is the greater.

● Nominal working point



### ALB06RBS/LBS

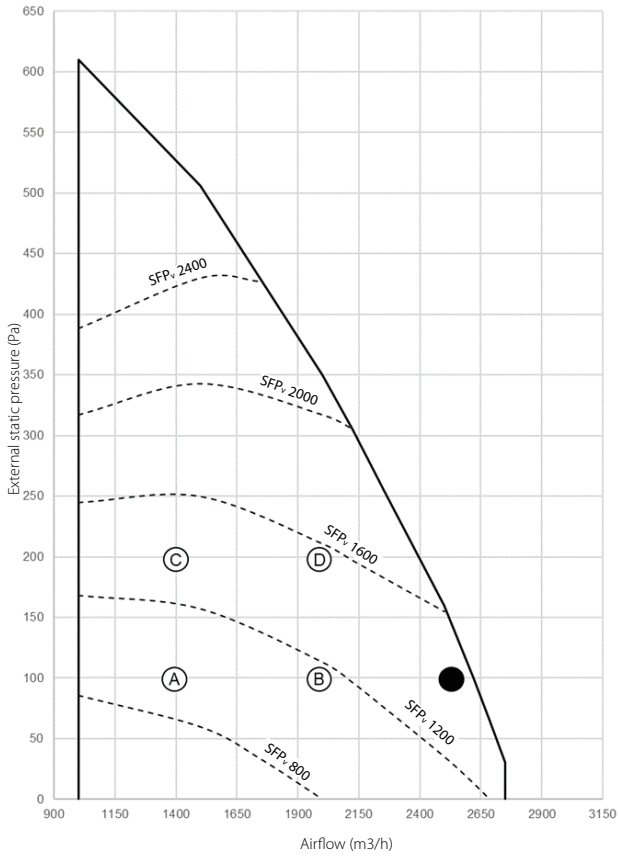

The diagram shows the available external pressure for the duct system given an airflow.

**SFPv = Specific Fan Power (W/m³/s)**

The SFPv curves are referring to the complete unit. Moreover, it includes power to both supply and extract fan divided by either the supply or extract volume whichever is the greater.

● Nominal working point

### ALB07RBS/LBS

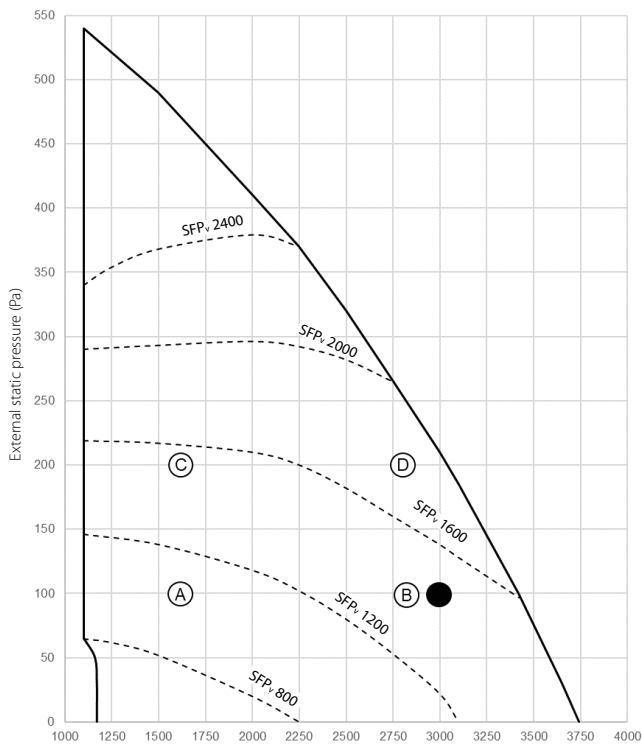

The diagram shows the available external pressure for the duct system given an airflow.

**SFPv = Specific Fan Power (W/m³/s)**

The SFPv curves are referring to the complete unit. Moreover, it includes power to both supply and extract fan divided by either the supply or extract volume whichever is the greater.

● Nominal working point



## Detailed technical drawings

### VAM150FC9

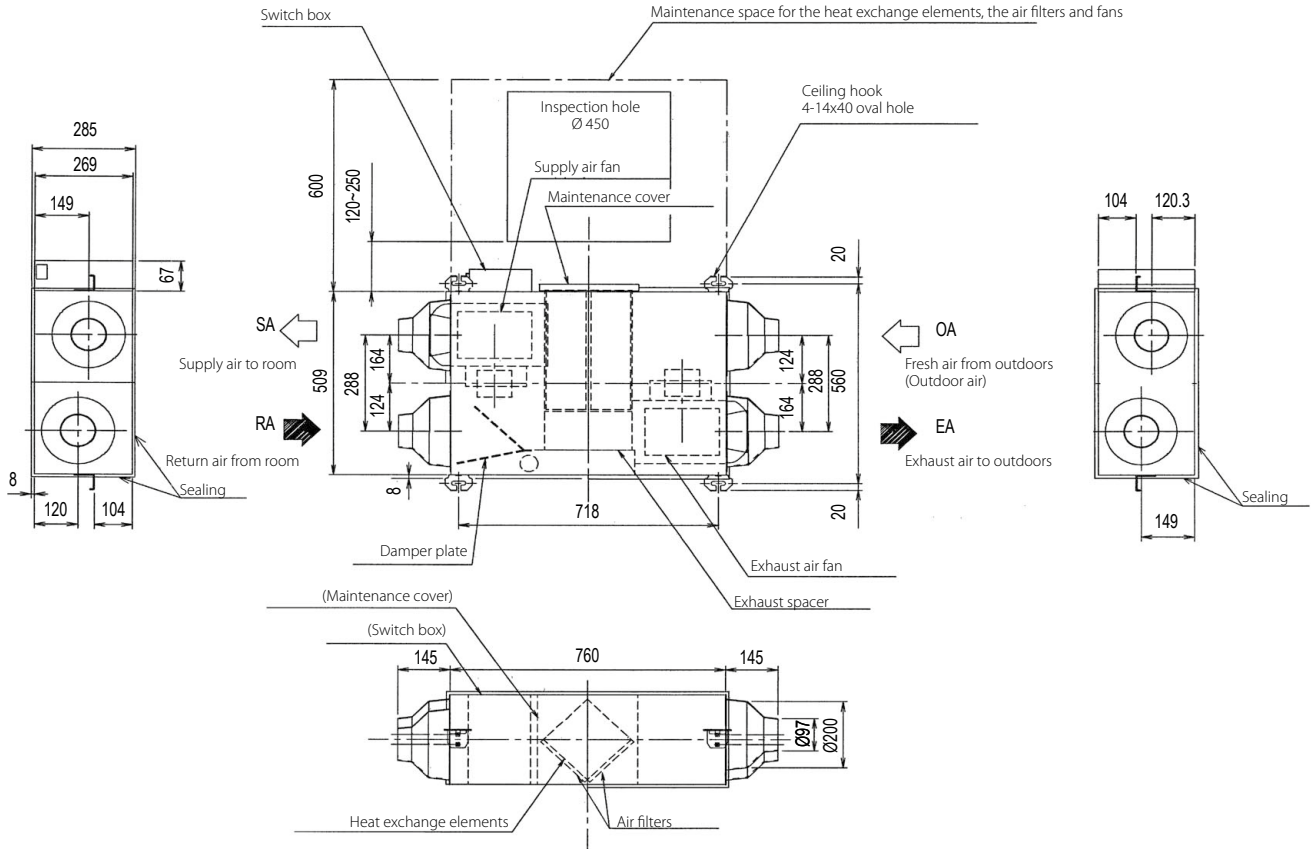

#### NOTES

1. Be sure to provide the inspection hole (450x450 mm) to inspect the air filters, the exchange elements and fans.

3TW27874-1

### VAM250FC9

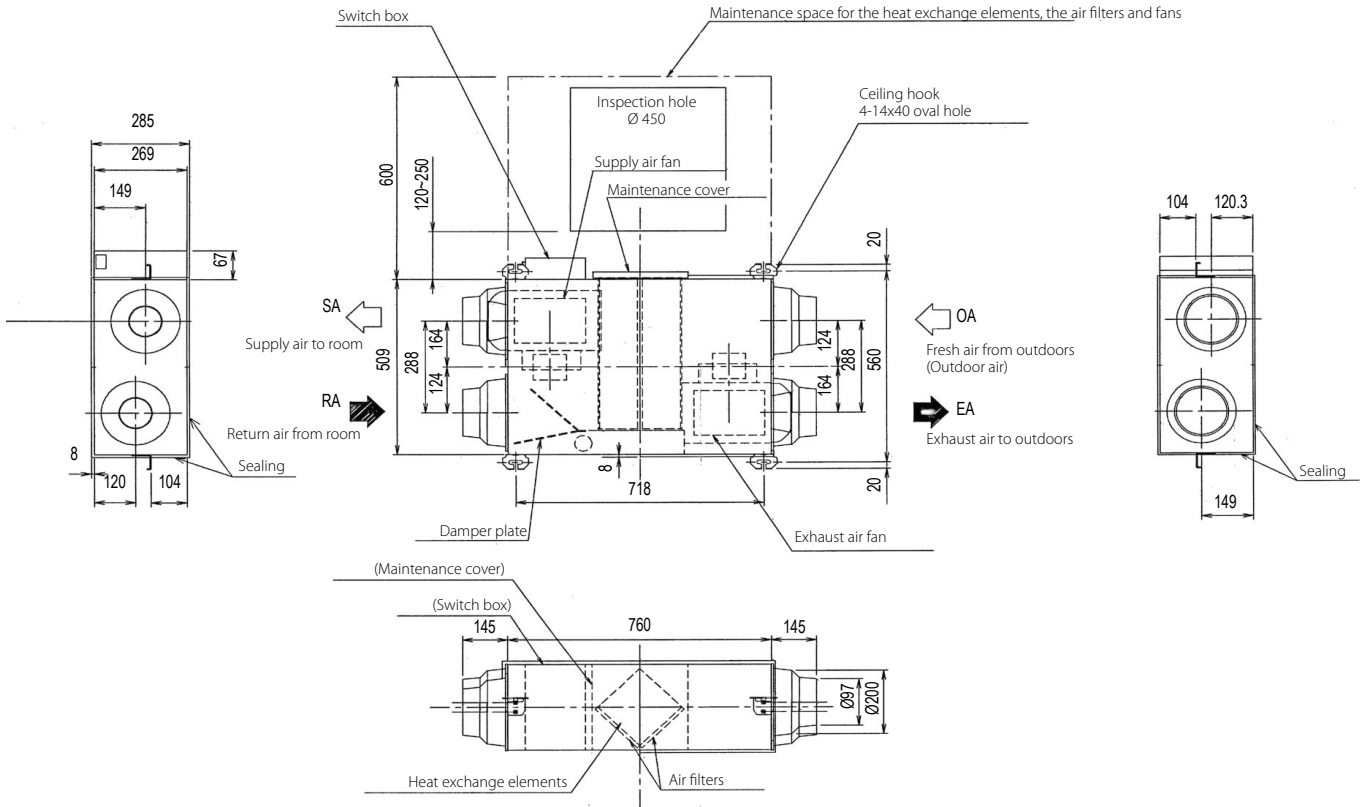

#### NOTES

1. Be sure to provide the inspection hole (450x450 mm) to inspect the air filters, the exchange elements and fans.

3TW27884-1





**VAM350-500J8**

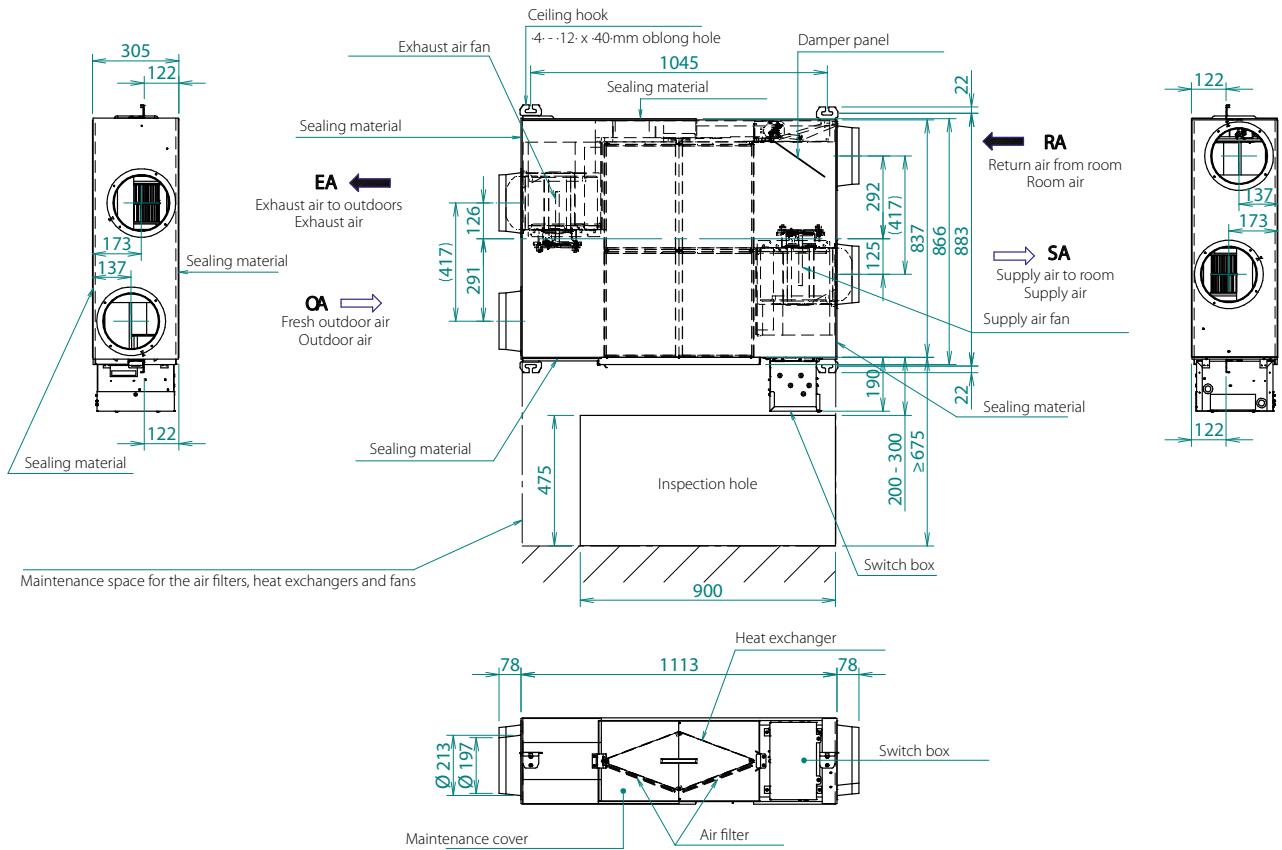

**NOTES**

1. To allow for the inspection of the air filters, heat exchangers, and fans, be sure to provide the inspection hole.

**3D112815C**

**VAM650J8**

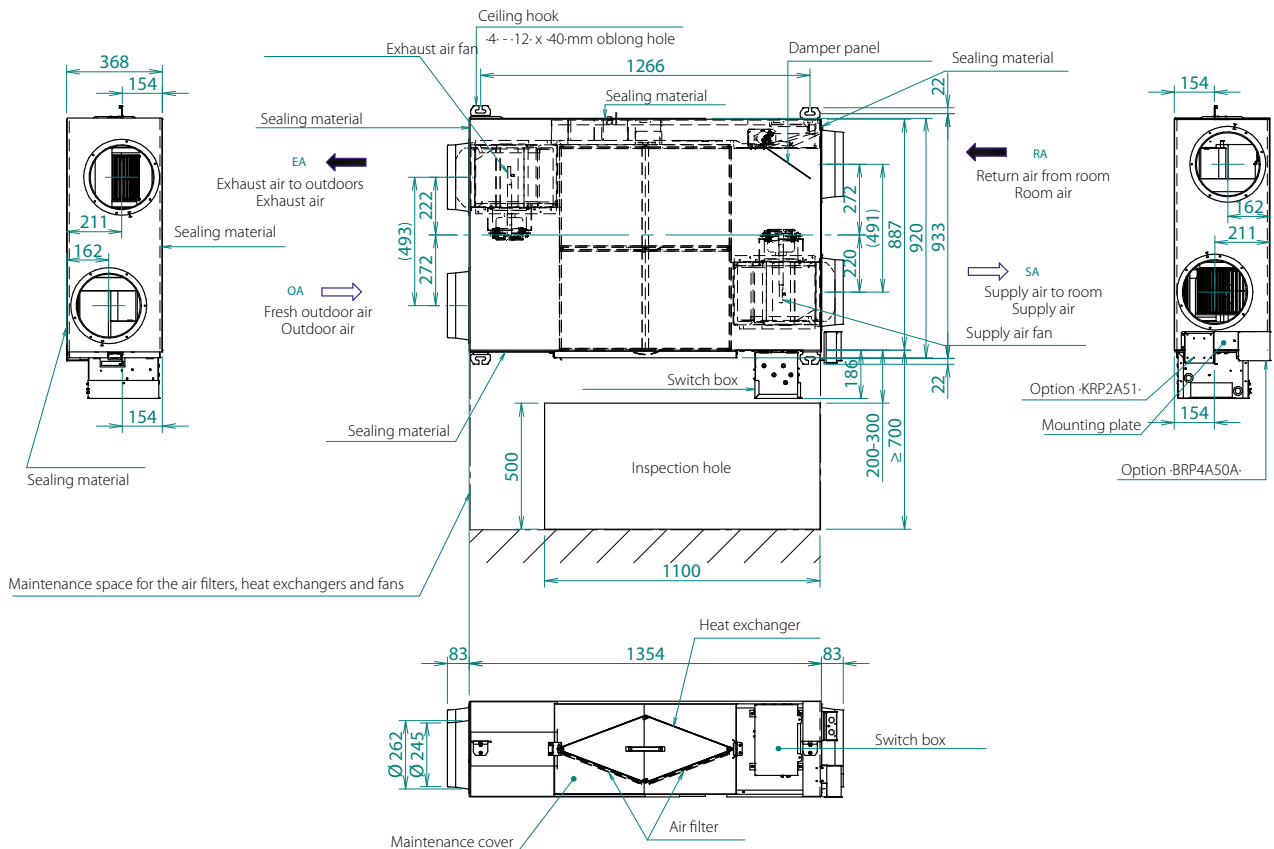

**NOTES**

1. To allow for the inspection of the air filters, heat exchangers, and fans, be sure to provide the inspection hole.

**3D113502A**



Detailed technical drawings

**VAM800-1000J8**

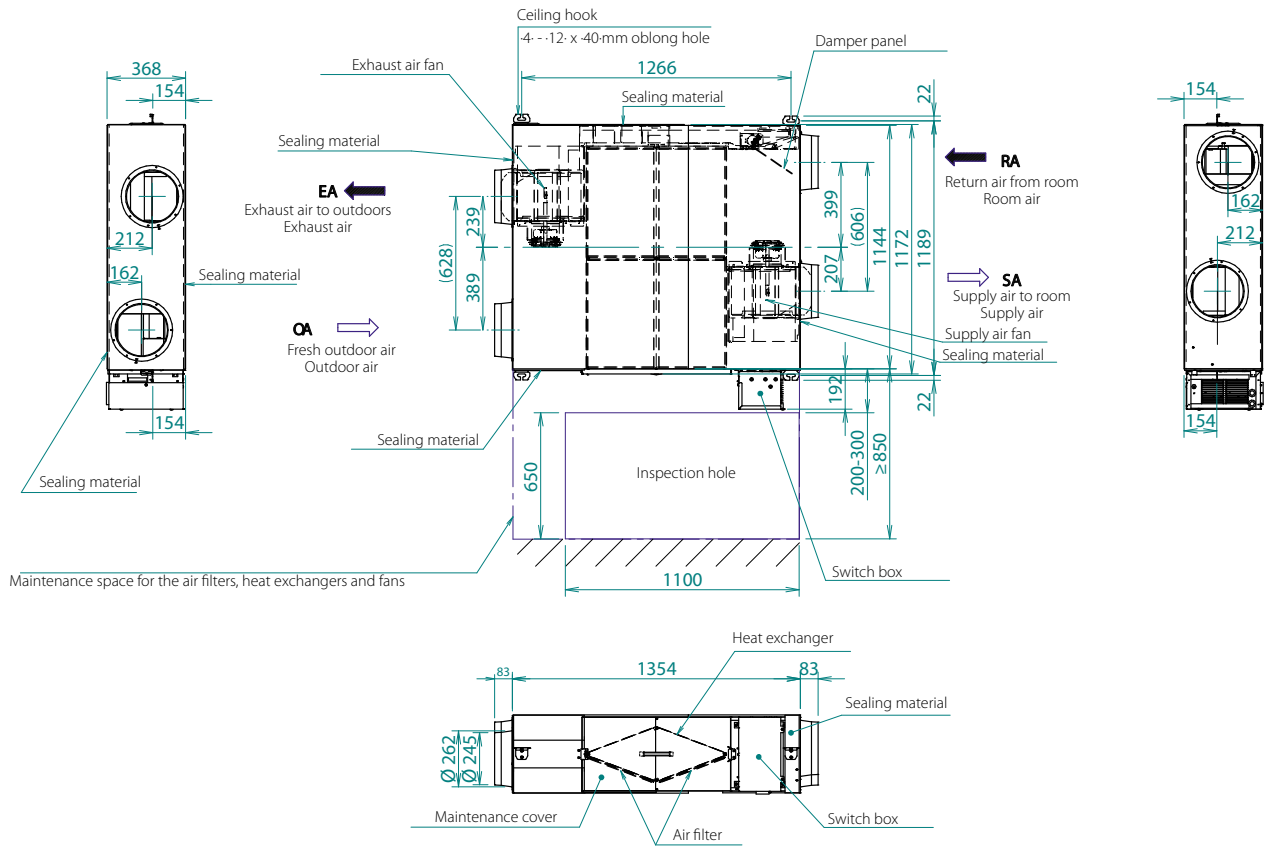

**NOTES**

1. To perform maintenance on the air filter, it is required to provide a service access panel.

**3D112817D**

**VAM1500-2000J8**

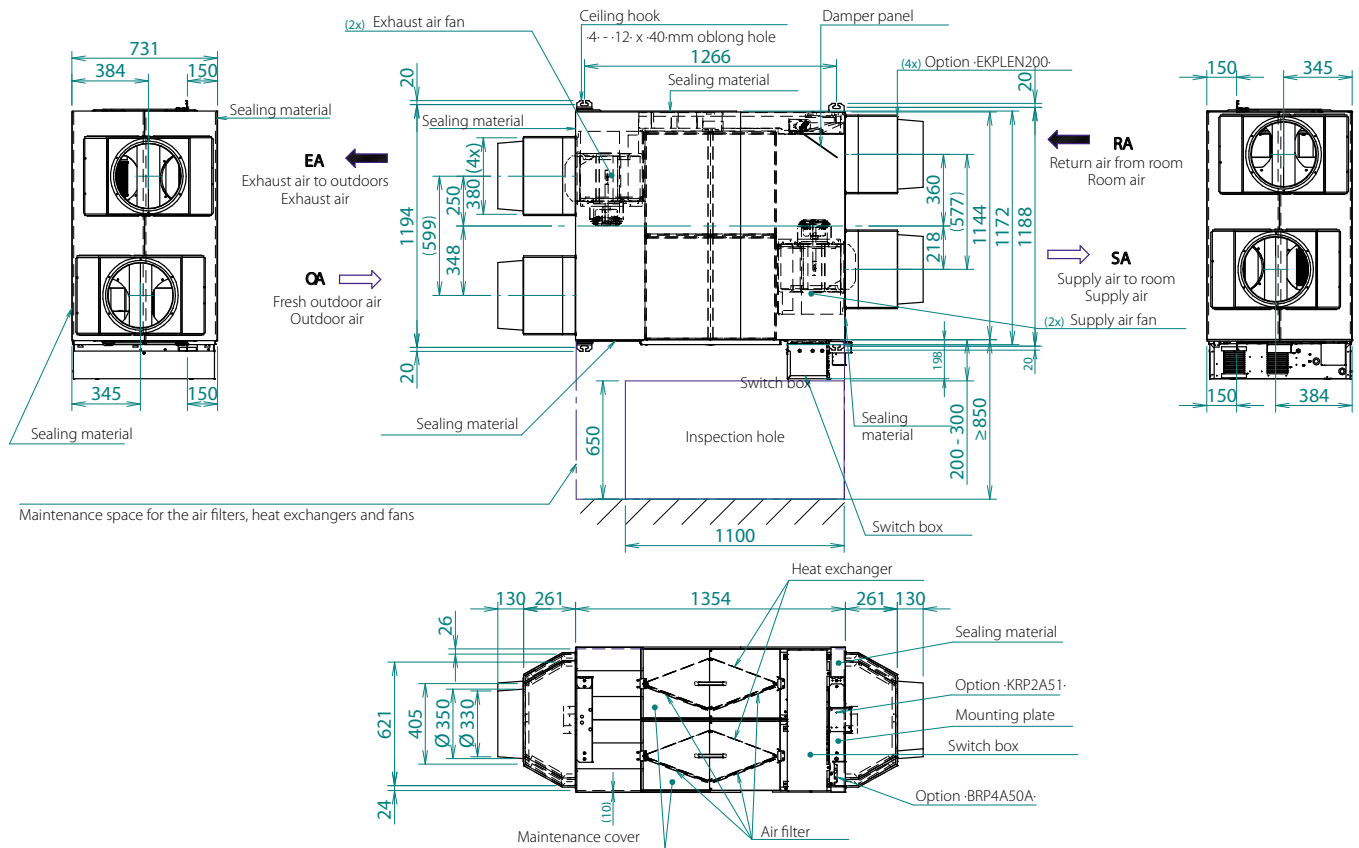

**NOTES**

1. To allow for the inspection of the air filters, heat exchangers, and fans, be sure to provide the inspection hole.

**3D112818C**

**VAM150FC9**

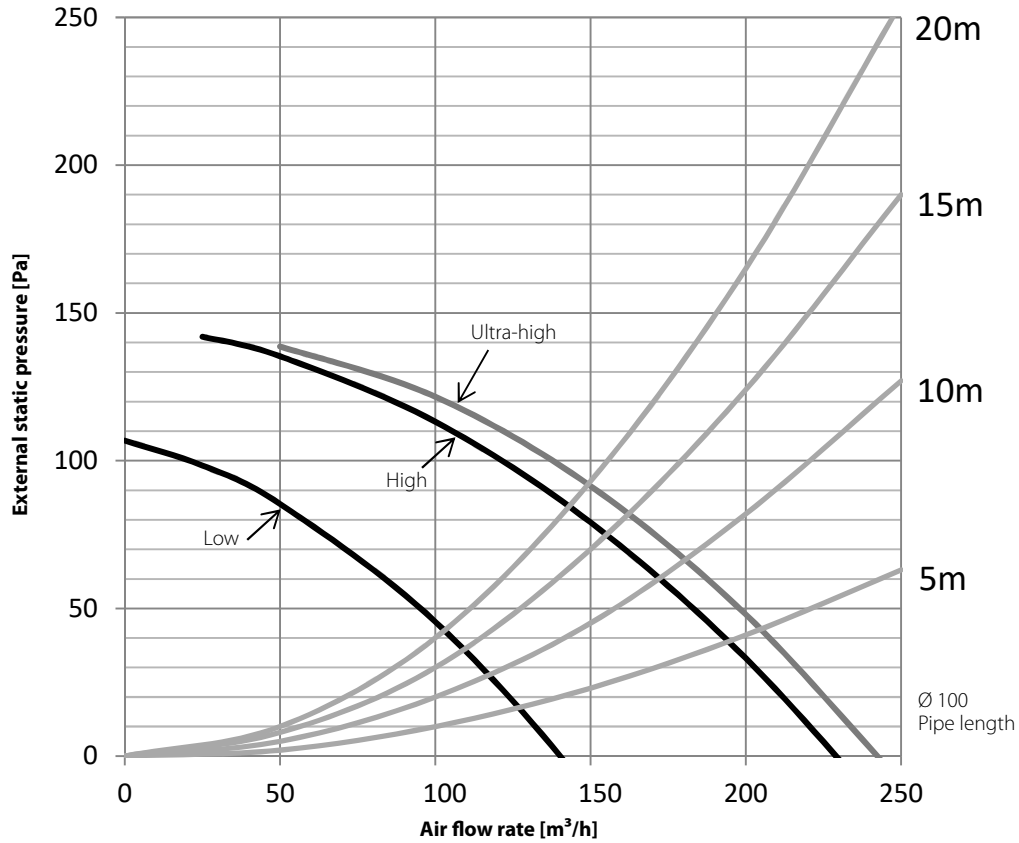

**NOTES**

1. The fan speeds are valid for ~230-V, ~50-Hz power supply.

**4D100379A**

**VAM250FC9**

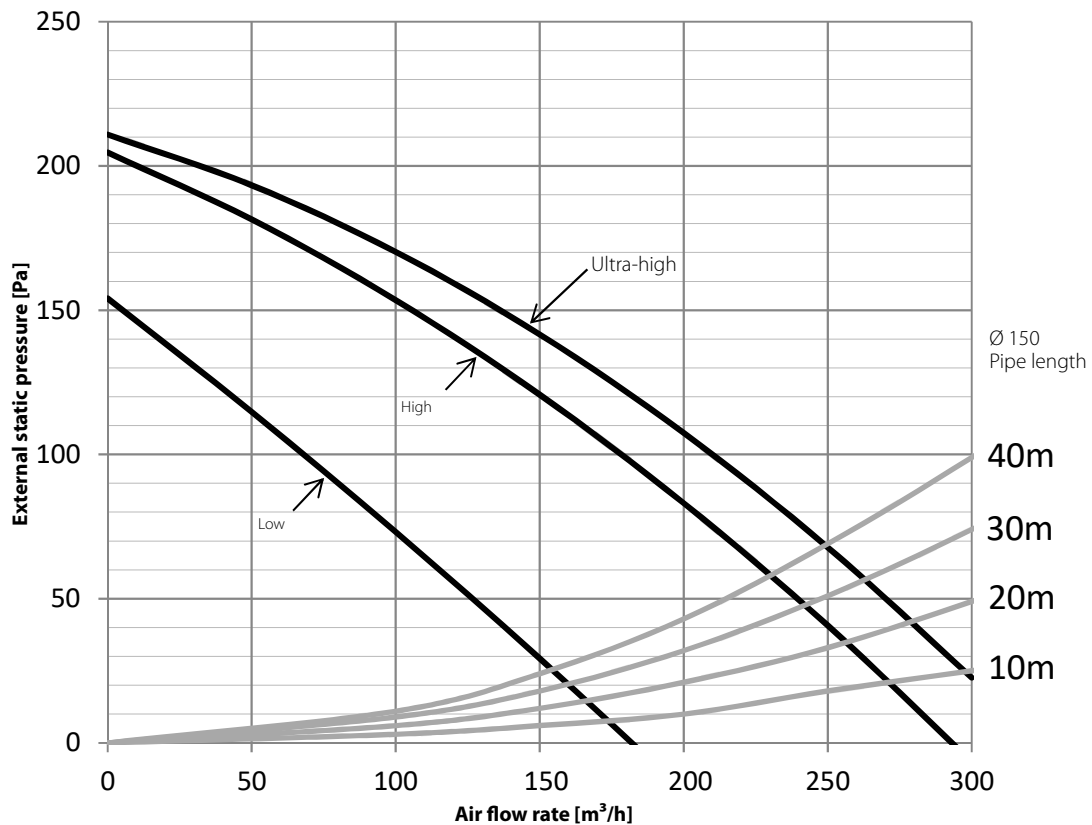

**NOTES**

1. The fan speeds are valid for ~230-V, ~50-Hz power supply.

**4D100380A**



### Detailed technical drawings

## VAM350J8

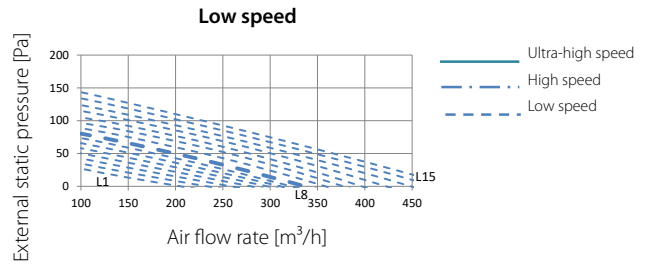
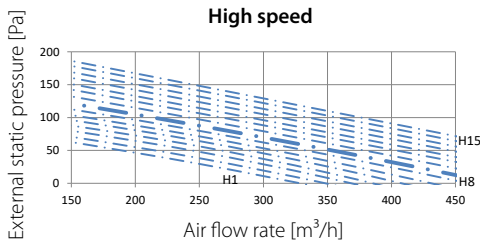
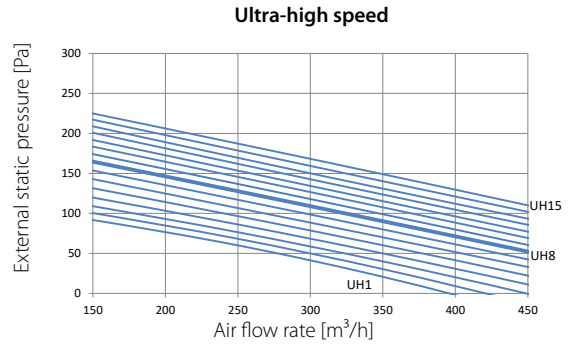
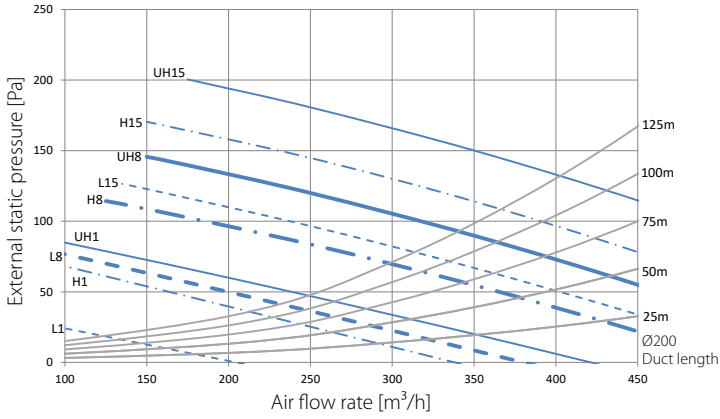

#### NOTES

- The fan curves are determined with  $\cdot 1/3$  of the ESP on the outdoor side (EA & OA), and  $\cdot 2/3$  of the ESP on the indoor side (RA & SA).  
EA = Exhaust air  
OA = Outdoor air  
RA = Room air  
SA = Supply air
- Measured according to JIS B 8628 - 2003.

#### LEGEND

- L1 = Low speed lower limit
- L8 = Low speed factory setting
- L15 = Low speed upper limit
- H1 = High speed lower limit
- H8 = High speed factory setting

- H15 = High speed upper limit
- UH1 = Ultra-high speed lower limit
- UH8 = Ultra-high speed factory setting
- UH15 = Ultra-high speed upper limit

3D113493B

## VAM500J8

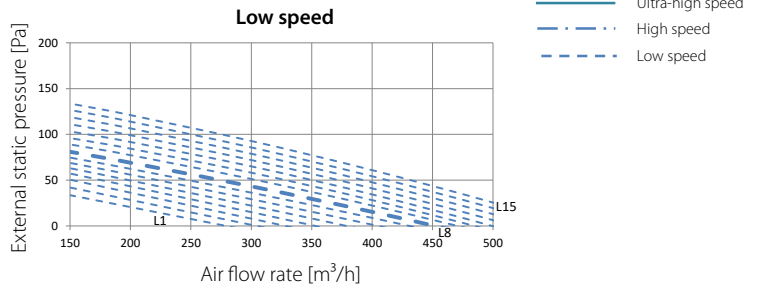
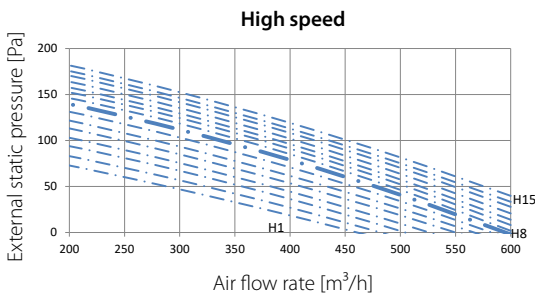
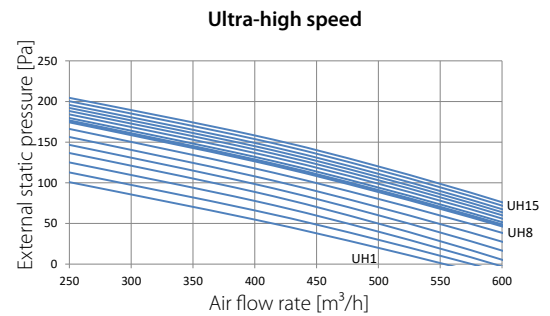
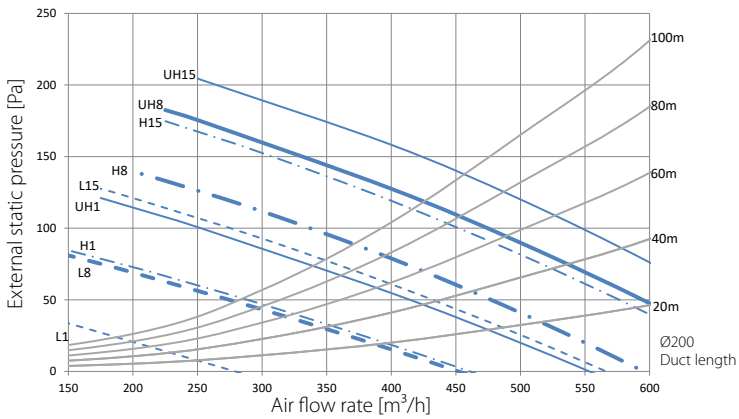

#### NOTES

- The fan curves are determined with  $\cdot 1/3$  of the ESP on the outdoor side (EA & OA), and  $\cdot 2/3$  of the ESP on the indoor side (RA & SA).  
EA = Exhaust air  
OA = Outdoor air  
RA = Room air  
SA = Supply air
- Measured according to JIS B 8628 - 2003.

#### LEGEND

- L1 = Low speed lower limit
- L8 = Low speed factory setting
- L15 = Low speed upper limit
- H1 = High speed lower limit
- H8 = High speed factory setting

- H15 = High speed upper limit
- UH1 = Ultra-high speed lower limit
- UH8 = Ultra-high speed factory setting
- UH15 = Ultra-high speed upper limit

3D113494B



### VAM650J8

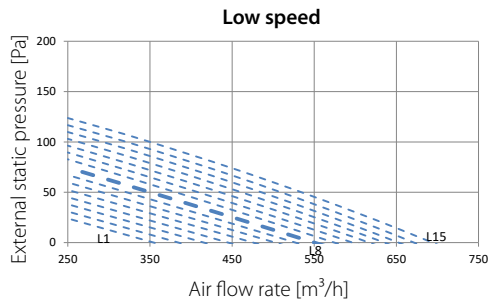
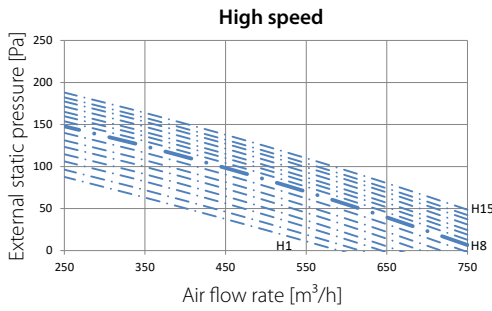
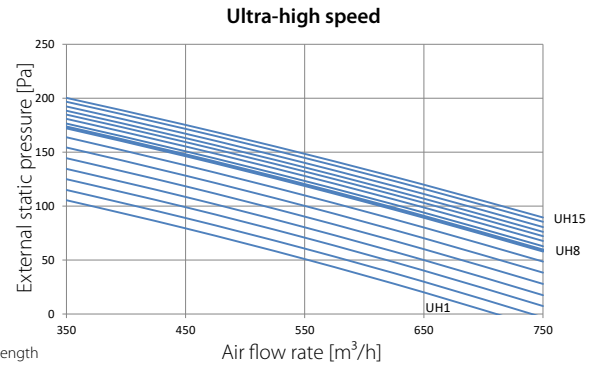
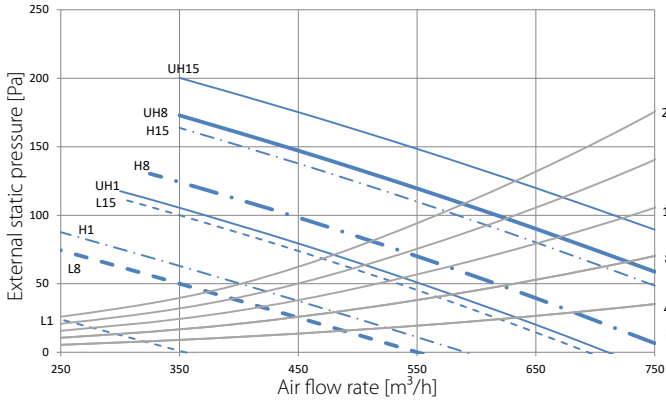

— Ultra-high speed  
- - - High speed  
- - - Low speed

#### NOTES

- The fan curves are determined with 1/3 of the ESP on the outdoor side (EA & OA), and 2/3 of the ESP on the indoor side (RA & SA).  
EA = Exhaust air  
OA = Outdoor air  
RA = Room air  
SA = Supply air
- Measured according to JIS B 8628 - 2003.

#### LEGEND

- L1 = Low speed lower limit  
L8 = Low speed factory setting  
L15 = Low speed upper limit  
H1 = High speed lower limit  
H8 = High speed factory setting

- H15 = High speed upper limit  
UH1 = Ultra-high speed lower limit  
UH8 = Ultra-high speed factory setting  
UH15 = Ultra-high speed upper limit

3D113495B

### VAM800J8

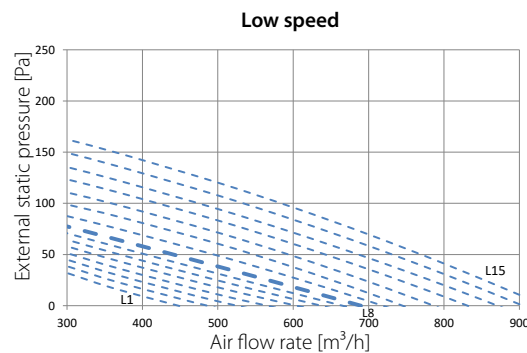
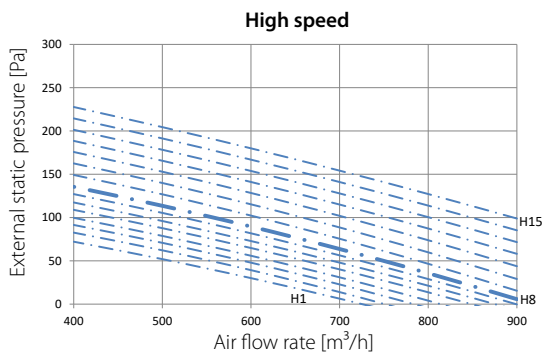
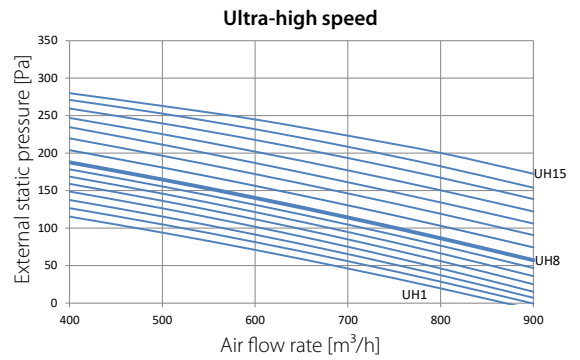
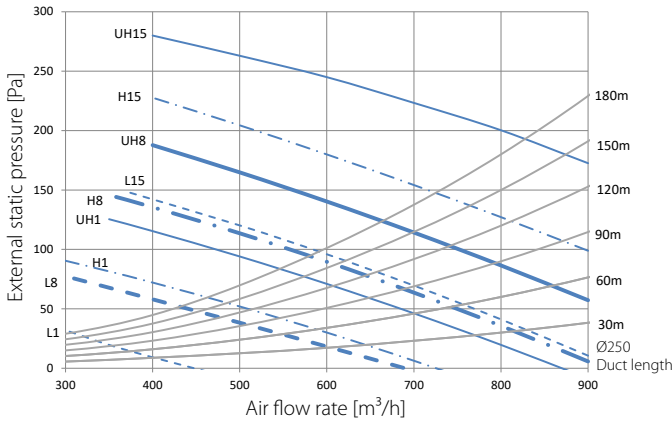

— Ultra-high speed  
- - - High speed  
- - - Low speed

#### NOTES

- The fan curves are determined with 1/3 of the ESP on the outdoor side (EA & OA), and 2/3 of the ESP on the indoor side (RA & SA).  
EA = Exhaust air  
OA = Outdoor air  
RA = Room air  
SA = Supply air
- Measured according to JIS B 8628 - 2003.

#### LEGEND

- L1 = Low speed lower limit  
L8 = Low speed factory setting  
L15 = Low speed upper limit  
H1 = High speed lower limit  
H8 = High speed factory setting

- H15 = High speed upper limit  
UH1 = Ultra-high speed lower limit  
UH8 = Ultra-high speed factory setting  
UH15 = Ultra-high speed upper limit

3D112837A



### Detailed technical drawings

## VAM1000J8

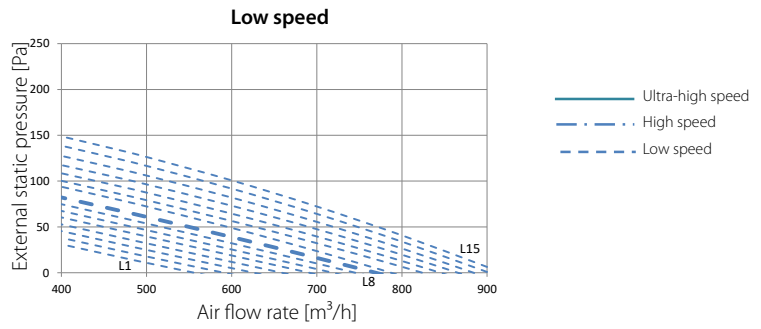
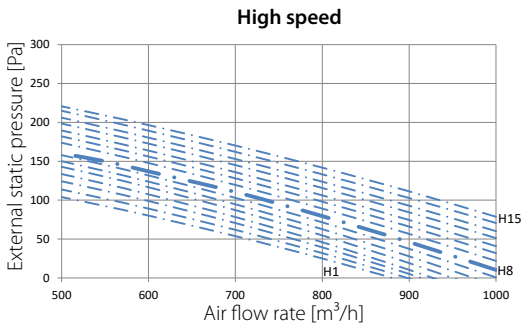
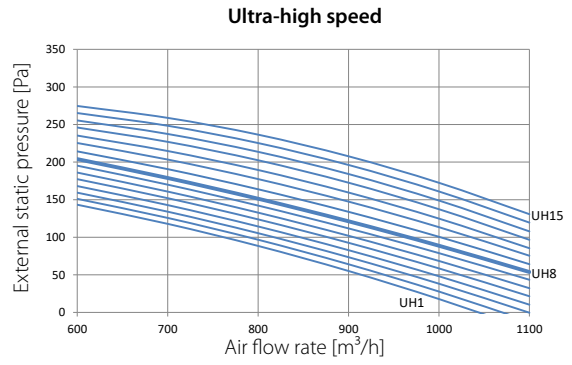
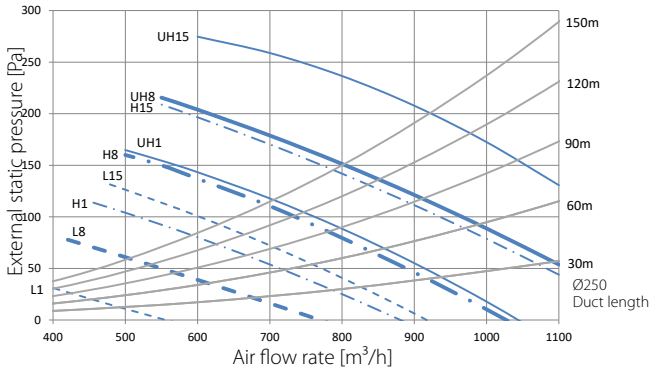

### NOTES

- The fan curves are determined with 1/3 of the ESP on the outdoor side (EA & OA), and 2/3 of the ESP on the indoor side (RA & SA).  
EA = Exhaust air  
OA = Outdoor air  
RA = Room air  
SA = Supply air
- Measured according to JIS B 8628 - 2003.

### LEGEND

- L1 = Low speed lower limit
- L8 = Low speed factory setting
- L15 = Low speed upper limit
- H1 = High speed lower limit
- H8 = High speed factory setting
- H15 = High speed upper limit
- UH1 = Ultra-high speed lower limit
- UH8 = Ultra-high speed factory setting
- UH15 = Ultra-high speed upper limit

3D112832A

## VAM1500J8

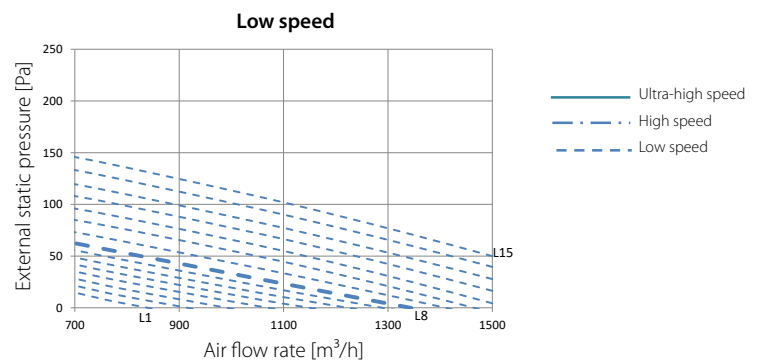
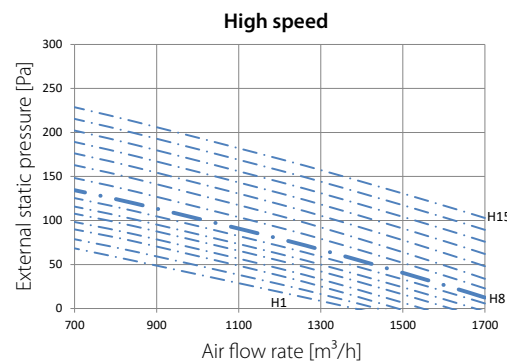
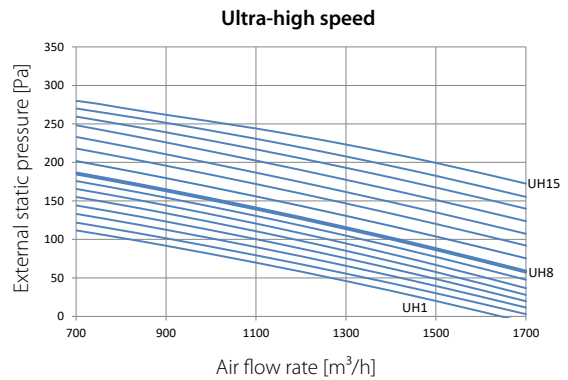
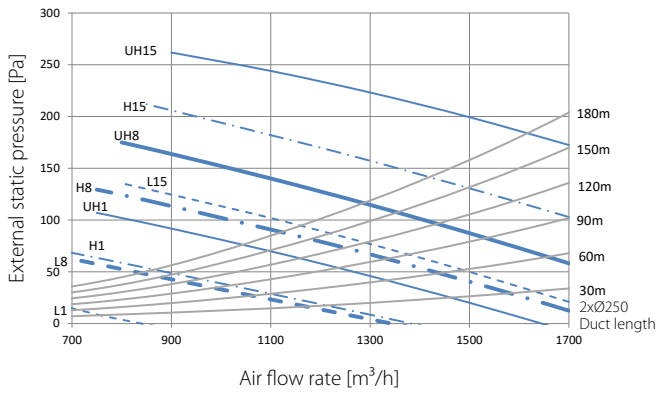

### NOTES

- The fan curves are determined with 1/3 of the ESP on the outdoor side (EA & OA), and 2/3 of the ESP on the indoor side (RA & SA).  
EA = Exhaust air  
OA = Outdoor air  
RA = Room air  
SA = Supply air
- Measured according to JIS B 8628 - 2003.

### LEGEND

- L1 = Low speed lower limit
- L8 = Low speed factory setting
- L15 = Low speed upper limit
- H1 = High speed lower limit
- H8 = High speed factory setting
- H15 = High speed upper limit
- UH1 = Ultra-high speed lower limit
- UH8 = Ultra-high speed factory setting
- UH15 = Ultra-high speed upper limit

3D112838A



**VAM2000J8**

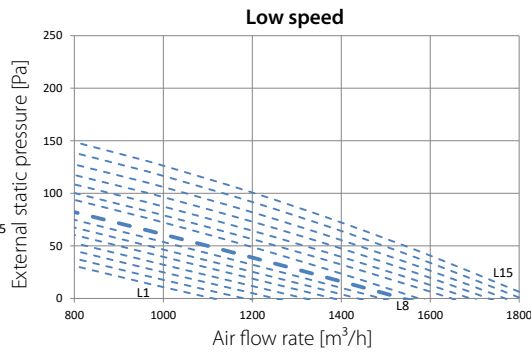
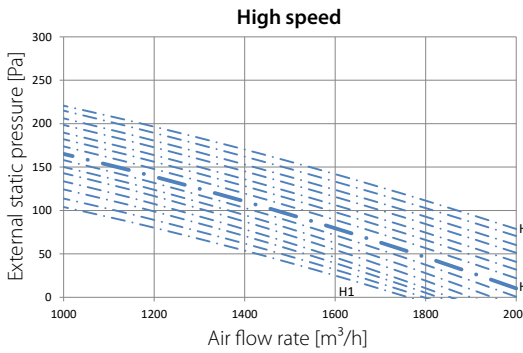
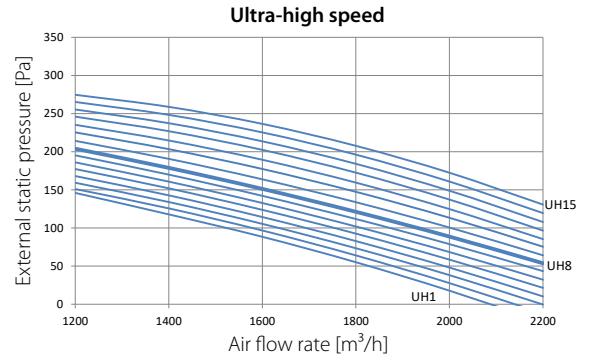
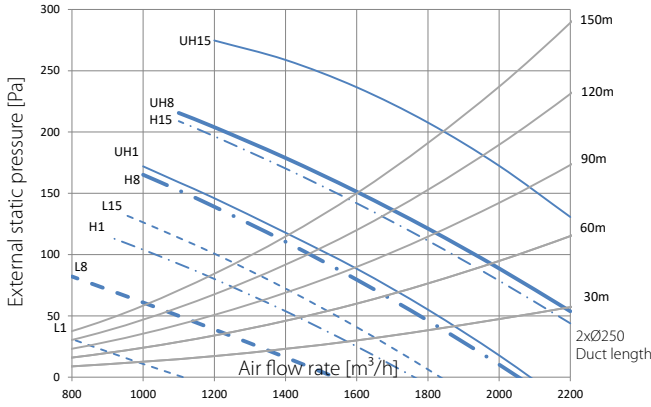

— Ultra-high speed  
- · - High speed  
- - - Low speed

**NOTES**

- The fan curves are determined with 1/3 of the ESP on the outdoor side (EA & OA), and 2/3 of the ESP on the indoor side (RA & SA).  
EA = Exhaust air  
OA = Outdoor air  
RA = Room air  
SA = Supply air
- Measured according to JIS B 8628 - 2003.

**LEGEND**

- L1 = Low speed lower limit
- L8 = Low speed factory setting
- L15 = Low speed upper limit
- H1 = High speed lower limit
- H8 = High speed factory setting
- H15 = High speed upper limit
- UH1 = Ultra-high speed lower limit
- UH8 = Ultra-high speed factory setting
- UH15 = Ultra-high speed upper limit

**3D112839A**



Low height.  
High value.

## More flexibility for your business with single fan casings in the whole Sky Air range

**Unique to the market:** We proudly present our new low-height single fan outdoor units across all Sky Air ranges – from 3.5 to 25 kW.

- › More flexibility in positioning, easier transport and installation
- › Market-leading serviceability and handling – with easy access to all components and 7-segment display
- › Reliable cooling thanks to refrigerant cooled PCB
- › Full portfolio of connectable R-32 indoor units



[www.daikin.eu/skyairbluevolution](http://www.daikin.eu/skyairbluevolution)

**BLUEEVOLUTION**

**SkyAir**  
Alpha-series

**SkyAir**  
Advance-series

**Daikin Europe N.V.** Naamloze Vennootschap Zandvoordestraat 300 · 8400 Oostende · Belgium · [www.daikin.eu](http://www.daikin.eu) · BE 0412 120 336 · RPR Oostende (Publisher)

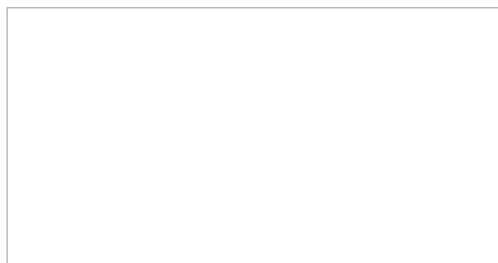

ECPEN22-100

11/21



Daikin Europe N.V. participates in the Eurovent Certified Performance programme for Fan Coil Units and Variable Refrigerant Flow systems. Check ongoing validity of certificate: [www.eurovent-certification.com](http://www.eurovent-certification.com)

The present publication is drawn up by way of information only and does not constitute an offer binding upon Daikin Europe N.V. Daikin Europe N.V. has compiled the content of this publication to the best of its knowledge. No express or implied warranty is given for the completeness, accuracy, reliability or fitness for particular purpose of its content and the products and services presented therein. Specifications are subject to change without prior notice. Daikin Europe N.V. explicitly rejects any liability for any direct or indirect damage, in the broadest sense, arising from or related to the use and/or interpretation of this publication. All content is copyrighted by Daikin Europe N.V.

Printed on non-chlorinated paper.