

Air handling units

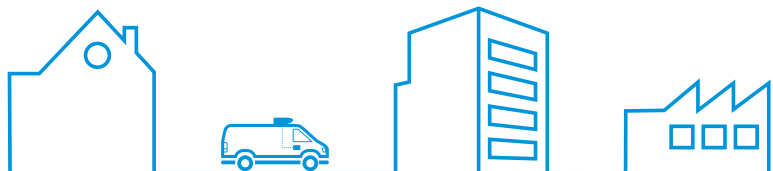



Air handling units

Why choose Daikin air handling units?	762
Products overview	766
Software and Eurovent certification	767
The working principle at a glance	768
Professional and Digital Controls	770
Modular R	772
Modular P	773
Modular L	774
NEW Modular T	775
Daikin fresh air package	776

Daikin air handling units



Why choose Daikin air handling units?

- › Maximum energy efficiency and indoor air quality
- › Wide range of functions and options
- › **High quality** components
- › **Innovative** technology: Unique features and state of the art technology for short payback
- › Operation **efficiency** and **energy savings**
- › Outstanding **reliability** and **performance**
- › Various applications are possible including air conditioning applications, industry-type process cooling, and large-scale district heat source systems
- › Plug and play concept for easy installation and commissioning
- › Unique Daikin fresh air package available for connection of AHU to VRV or ERQ

Certifications

- › Eurovent certified performances
- › Exceeding 2018 ErP – ECODESIGN requirements
- › Certified according to the Hygiene Directive VDI 6022 (Modular L and Professional ranges)
- › Certified according to the Hygiene Directive DIN 1946 (Professional range)
- › RLT certified performances



The unique quality of Daikin AHU is accomplished by:

Panels

- › The outer panel is Pre-painted with Corrosion Class RC5
- › The inner panel is made of Aluzinc with Corrosion Class RC4

Gasket

- › Liquid gasket technology drastically reduces unit air leakage

Frame

- › All anodized aluminium which has the highest corrosion resistance compared to natural aluminium
- › Unique Daikin thermal break (35 mm or 27 mm thermal break). Polyamide bars design to enhance thermal break unit performances
- › Distinctive Section to section thermal break profile to ensure thermal break design on the whole unit
- › Rounded profile for increased ease of cleaning

IAQ

- › Flush internal surface and rounded corner flush surface to avoid the retention of dirt and to be easily cleanable
- › Wide filtration possibility to reduce pollution

Plug & Play Controls

- › Pre-commissioned and Factory-tested control for quicker on site commissioning
- › Sole manufacturer to provide a complete AHU DX solution from a single manufacturer available for connection of AHU to VRV or ERQ (everything factory-mounted)

Marketing tools

- › Watch the time-lapse video of a Daikin AHU construction on www.youtube.com/daikineurope
- › Watch the Modular L promotional video on www.youtube.com/daikineurope
- › Download our brochure on air handling units from my.daikin.eu
- › Get the access to the selection tool <http://tools.daikinapplied.eu> to select your air handling units in a few clicks.
- › Download the Modular L “Daikin Air Design” App on the App stores for iOS and Android



- › Consult the “Argue Card” document to support in promoting the Modular L range (*available on request – refer to your Daikin AHU specialist*)

BIM models

- › Get the Modular L and T BIM models on bim.daikin.eu
- › Get the BIM tool plugin for Revit for Professional and Modular R/P series

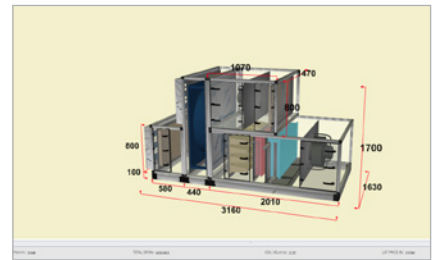
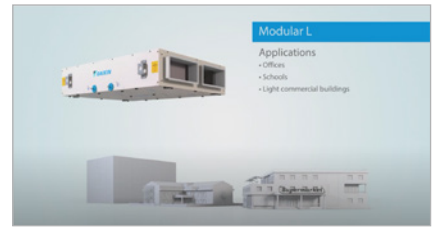
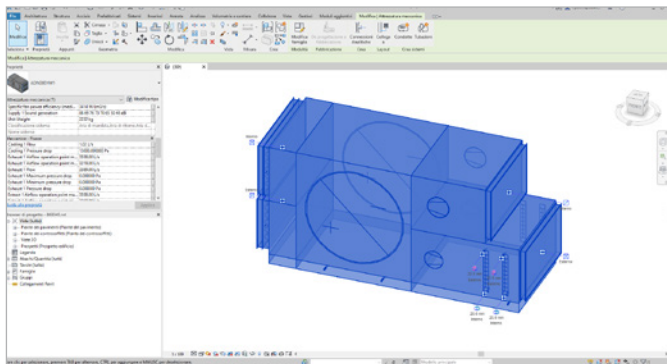

Benefits for the installer

Plug and play design

- › Pre-programmed and factory-tested controls for an easier and fast commissioning
- › Low voltage fast connectors between AHU sections
- › Flush mounted or external electrical control panel

Daikin Fresh air package

- › Plug & Play connection of Professional or Modular AHU to Daikin VRV and ERQ
- › Factory-mounted package contains expansion valves, electronic interface and sensors

Benefits for the consultant

Quick selection tool

- › In-house developed web software with improved user interface and preset parameters ensure that you can always find the optimum and most energy efficient product for your application
- › Extremely flexible design
- › Infinite variable sizes (increments of 1 cm)

BIM models

- › Regardless if your AHU is standard or fully customized, BIM models are available and can be downloaded with just a few clicks

Benefits for the end user

Customized or standard

- › Amazing tailor-made capability to meet the specific customer needs with the Professional range or fast availability thanks to the “make to stock” standard Modular L and T range

Efficient control logic

- › Open communication protocols (BACnet and Modbus) that guarantee BMS, and iTM compatibility
- › Energy efficient controls with reduced energy and operating cost
- › Highest efficiency ensure savings on energy consumption costs





D-AHU MODULAR R
INSTALLATION



COMFORTABLE
INDOOR CLIMATE

Products overview

Centralized ventilation

D-AHU Professional

- > Infinite variable sizes
- > Tailored to the individual customer

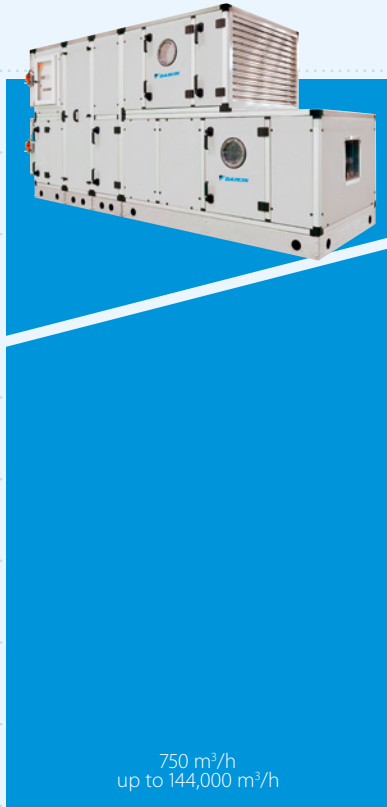

750 m³/h
up to 144,000 m³/h

D-AHU Modular R

- > Pre-configured sizes
- > Plug and play concept
- > EC Fan technology
- > Heat recovery wheel (sorption and sensible technology)
- > Compact design



500 m³/h
up to 25,000 m³/h

D-AHU Modular P

- > Pre-configured sizes
- > Plug and play concept
- > EC Fan technology
- > High efficiency aluminium counter flow PHE
- > Compact design



500 m³/h
up to 25,000 m³/h

Eurovent certification

Daikin Applied Europe S.p.A. participates in the Eurovent Certified Performance programme for Air Handling Units. Check ongoing validity of certificate: www.eurovent-certification.com or www.certiflash.com



Result Energy TermiC° S2&F2		Eurovent Classification according to EN1886				
D1	Casing strength class	D1	D2	D3		
	Max. relative deflection mm x m ⁻¹	4.00	10.00	Exceeding10		
L1	Casing air leakage class at -400 Pa	L1	L2	L3		
	Max. leakage rate (f ₄₀₀) l x s ⁻¹ x m ⁻²	0.15	0.44	1.32		
L1	Casing air leakage lass at +700 Pa	L1	L2	L3		
	Max. leakage rate (f ₇₀₀) l x s ⁻¹ x m ⁻²	0.22	0.63	1.90		
ePM ₁ 80% (F9)	Filter bypass leakage class	ePM ₁ 80% (F9)	ePM ₁ 70% (F8)	ePM ₁ 50% (F7)	ePM _{2.5} 50% (M6)	ISO Coarse
	Max. filter bypass leakage rate k in % of the volume flow rate	0.50	1	2	4	6
T2	Thermal transmittance	T1	T2	T3	T4	T5
	(U) W x m ⁻² x K ⁻¹	U <= 0.5	0.5 < U <= 1	1 < U <= 1.4	1.4 < U <= 2	No requirements
TB2	Thermal bridging factor	TB1	TB2	TB3	TB4	TB5
	(kb)	0.75 < K _b <= 1	0.6 < K _b <= 0.75	0.45 < K _b <= 0.6	0.3 < K _b <= 0.45	No requirements

Decentralized ventilation

Modular L

- › Pre-configured sizes
- › Plug and play concept
- › EC Fan technology
- › High efficiency aluminium counter flow PHE
- › Low height unit
- › For false ceiling applications



150 m³/h
up to 3,400 m³/h

Modular T

- › Pre-configured sizes
- › Plug and play concept
- › EC Fan technology
- › Small footprint
- › Compact design
- › High efficiency aluminium counter flow PHE
- › Top connected unit



200 m³/h
up to 4,200 m³/h

Centralized ventilation



Professional



Modular R & P

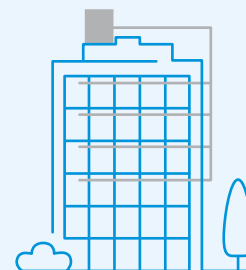

Decentralized ventilation



Modular T



Modular L

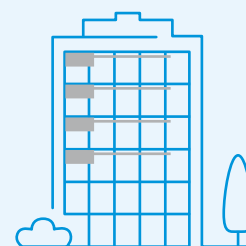

Selection software

ASTRA Web

- › Quick AHU selection that will save you precious time, drastically reducing selection time through the new software interface.
- › Very competitive solution available within the Wizard thanks to pre-uploaded parameters.
- › High selection quality, thanks to the intelligence embedded within the software core.

Quickly select your air handling unit by following the wizard:

- 1 Select the series: D-AHU Professional, D-AHU Modular R, D-AHU Modular P, Modular L and Modular T
- 2 Insert the air flow supply and return
- 3 Insert the summer/winter air supply setpoint
- 4 Insert the summer/winter outdoor and extract temperature

You will get immediately your 3D result and it's ready to customize!

Now, you will be able to modify your unit (adding or changing components) in order to have a product that meets all your needs.

When finished a technical report, price list, fan curve chart can be generated. These final reports can be downloaded in different formats.



The working principle at a glance

Typical configurations for Daikin air handling units provide a versatile range of functions. Our system offers numerous options for customisation through an extensive range of variations and added functionality.

Supply side

- › Damper section including ventilation grilles, factory-mounted actuators
- › Premium efficiency filters with factory-mounted differential pressure manometer
- › Heat recovery system (cross flow and counter flow plate heat exchanger or rotary heat exchanger)
- › Mixing box with damper and factory-mounted actuators
- › Heating/cooling coil section with stainless steel condensate tray and drip protection
- › Supply air fan, EC technology (with hinged door, opening drive monitoring, mounted and cabled lighting and ON/OFF switch)

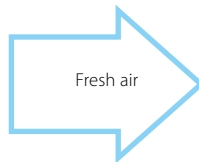

Fans

- › EC plug fan
- › Forward curved fan
- › Backward curved fan
- › Backward airfoil blades fan
- › Plug fan

Exchangers

- › Water coils
- › Steam coils
- › Direct expansion coil
- › Superheated water coils
- › Electric coils

Humidifiers

- › Evaporative humidifier without pump (loss water)
- › Evaporative humidifier with re-circulating pump
- › Steam humidifier with direct steam production
- › Steam humidifier with local distributor
- › Atomized water spray humidifier

Plug and Play control solution

- › Air flow control
- › Air temperature control
- › Chilled water and DX cooling system control
- › Free cooling
- › CO₂ automatic control
- › Air temperature control (supply, return, ambient)
- › Variable Air Volume (VAV) and Constant Air Volume (CAV) systems

Unique section to section thermal break profile

- › Thermal bridge free for the entire AHU
- › Smooth interior surface with improved IAQ (Indoor Air Quality)

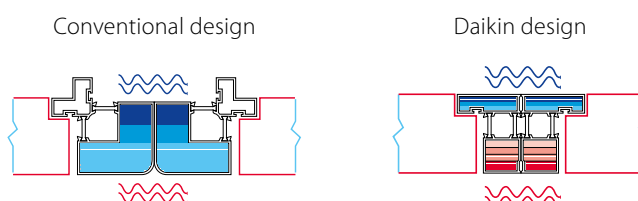

Return side



- › Premium efficiency filters with factory-mounted differential pressure manometer
- › Exhaust air fan, EC technology (with hinged door, opening drive monitoring, mounted and cabled lighting and ON/OFF switch)
- › Mixing box with damper and factory-mounted actuators

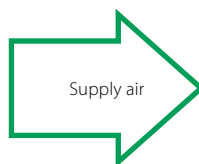

- › Heat recovery system (cross flow and counter flow plate heat exchanger or rotary heat exchanger)
- › Damper section including ventilation grilles, factory-mounted actuators

Heat recovery systems

- › Heat wheel, sensible or sorption
- › Cross flow and Counter flow plate heat exchangers
- › Run-around coils

Other section

- › Attenuator section
- › Mixing box section with actuators or manual controlled dampers
- › Empty section

Filters

- › Synthetic pleated filter
- › Flat filter aluminium mesh
- › Rigid bag filter
- › Soft bag filter
- › High efficiency filter
- › Carbon absorption filter
- › Carbon deodorizing filter

Accessories

- › Control features
- › Frost protection
- › Manometers
- › Drive guard
- › Roof
- › ...

Professional

Flexible solution for custom applications



Highlights

- › Air flow from 750 m³/h to 144,000 m³/h, for all customer needs
- › Indoor and outdoor versions
- › Custom designed to facilitate the transport and the assembly on site
- › Smooth interior surface with improved IAQ (Indoor Air Quality)
- › DX cooling system integration (VRV IV and ERQ coupling capability)
- › Daikin Digital Control compatible
- › Different heat recovery systems: heat wheel (sensible, enthalpy or sorption), cross flow and counter flow plate heat exchangers, run-around coils
- › Wide range of fans selectable: EC, AC plug, belt driven (forward curved, backward curved and backward airfoil blades)
- › Heating/cooling coil section with stainless steel condensate tray and drip protection
- › Different humidifiers available depending on customer needs
- › Premium efficiency filters with factory mounted differential pressure manometer
- › Profile in anodized aluminum with or without thermal break
- › Base frame in Galvanized steel, Aluminium, Stainless Steel 430 or 316
- › Panel insulation in polyurethane foam or mineral wool
- › Different material options selectable for internal, external panel skin: Pre-coated, Aluzinc, Aluminium, Stainless Steel 304 or 316
- › Wide range of accessories
- › Possibility to import BIM objects in Autodesk® Revit, thanks to a dedicated free plug-in available for [download](#)



Daikin Digital Control

Plug and play control system



Highlights

- › Free cooling/free heating management
- › VRV direct expansion systems management
- › Chilled water system control
- › Eco and reduced night modes
- › Up to 310 I/O (inputs/outputs)
- › All components internally wired
- › Fast connection between sections
- › Programming schedule
- › Indoor Air Quality (IAQ) controlled by CO₂ Probe
- › Regulation logic: Temperature Supply, Return, Ambient
- › Preloaded control parameters simplify the field commissioning
- › Unit delivered tested and programmed in the factory ensuring high quality level
- › Time and cost savings thanks to easy assembly on site
- › Minimum maintenance required
- › No involvement of external company or need of a third-party warranty thanks to integration of low and high voltage
- › User friendly control interface
- › Supervision and Control management local, remote options (Modbus, Bacnet)
- › Maximum flexibility in selecting the product and control feature directly from selection software



Daikin On Site

Control everywhere

The Daikin On Site platform offers different features and functions to monitor and control the unit.

The monitoring system makes available dashboards, remote access, scheduling, online graphics, diagnostics, software upgrade.



Modular R

Side connected rotary heat recovery air handling unit

Highlights

- › 10 predefined sizes
- › Airflow from 700 m³/h to 18,000 m³/h (ErP 2018)
- › Rotary heat recovery (Sensible or Sorption)
- › Compact design (only 720 mm depth)
- › Indoor and outdoor versions
- › Thermal bridge free for the entire AHU
- › Smooth interior surface with improved IAQ (Indoor Air Quality)
- › Indoor air quality compliant with VDI 6022 hygiene guideline
- › Chilled water system control
- › DX cooling system integration (VRV IV and ERQ coupling capability)
- › Advanced control features
- › Monitoring and control through Daikin iTM
- › Nominal air flow programmed at factory
- › Air flow or pressure control (Variable Air Volume - Constant Air Volume)
- › Free cooling capability
- › Economy and Night mode operation
- › Possibility to import BIM objects in Autodesk® Revit, thanks to a dedicated free plug-in available for [download](#)



Modular R

Air flow range

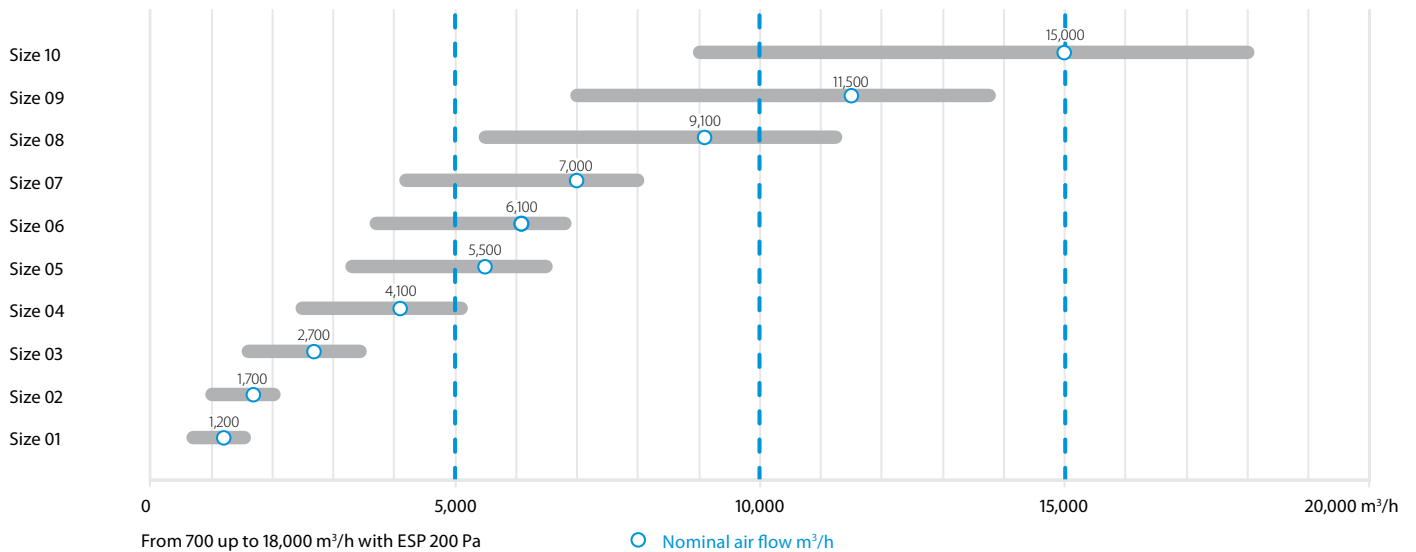

Technical details

More details and final information can be found by scanning or clicking the QR codes.



Modular R

Modular R			1	2	3	4	5	6	7	8	9	10	
Airflow	m ³ /h		1,200	1,700	2,700	4,100	5,500	6,100	7,000	9,100	11,500	15,000	
Temp. efficiency winter	%		76.9	76.7	77	77.2	78.5	77	78.4	78.7	77.9	78.2	
External static pressure	Nom. Pa		200										
Current ¹	Nom. A		2.6	3.65	2.24	3.27	4.23	5.14	5.79	6.92	9.39	12.56	
Power input ¹	Nom. kW		0.6	0.84	1.36	1.98	2.56	3.11	3.51	4.19	5.69	7.61	
SFPv ²	kW/m ³ /s		1.553	1.507	1.451	1.521	1.387	1.549	1.525	1.432	1.487	1.551	
Electrical supply	Phase	ph	1				3						
	Frequency	Hz	50										
	Voltage	V	230				400						
Dimensions unit	Width	mm	720	820	990	1,200	1,400	1,600	1,940	2,300			
	Height	mm	1,320		1,540	1,740		1,920	2,180	2,460	2,570		
	Length	mm	1,700		1,800	1,920	2,080	2,280	2,400	2,450	2,280	2,400	
Weight unit	kg		325	350	475	575	750	790	950	1,330	1,410	1,750	

1. Measured with dirty filters | 2. SFPv is a parameter that quantifies the fan efficiency (the lower it is the better will be). This reduces if airflow decreases.

Modular P

Side connected plate heat recovery air handling unit

Highlights

- › 10 predefined sizes
- › Airflow from 700 m³/h to 21,000 m³/h (ErP 2018)
- › Counterflow plate heat recovery
- › Compact design (only 720 mm depth)
- › Indoor and outdoor versions
- › Thermal bridge free for the entire AHU
- › Smooth interior surface with improved IAQ (Indoor Air Quality)
- › Indoor air quality compliant with VDI 6022 hygiene guideline
- › Chilled water system control
- › DX cooling system integration (VRV IV and ERQ coupling capability)
- › Advanced control features
- › Monitoring and control through Daikin iTM
- › Nominal air flow programmed at factory
- › Air flow or pressure control (Variable Air Volume - Constant Air Volume)
- › Free cooling capability
- › Economy and Night mode operation
- › Possibility to import BIM objects in Autodesk® Revit, thanks to a dedicated free plug-in available for [download](#)



Modular P

Air flow range

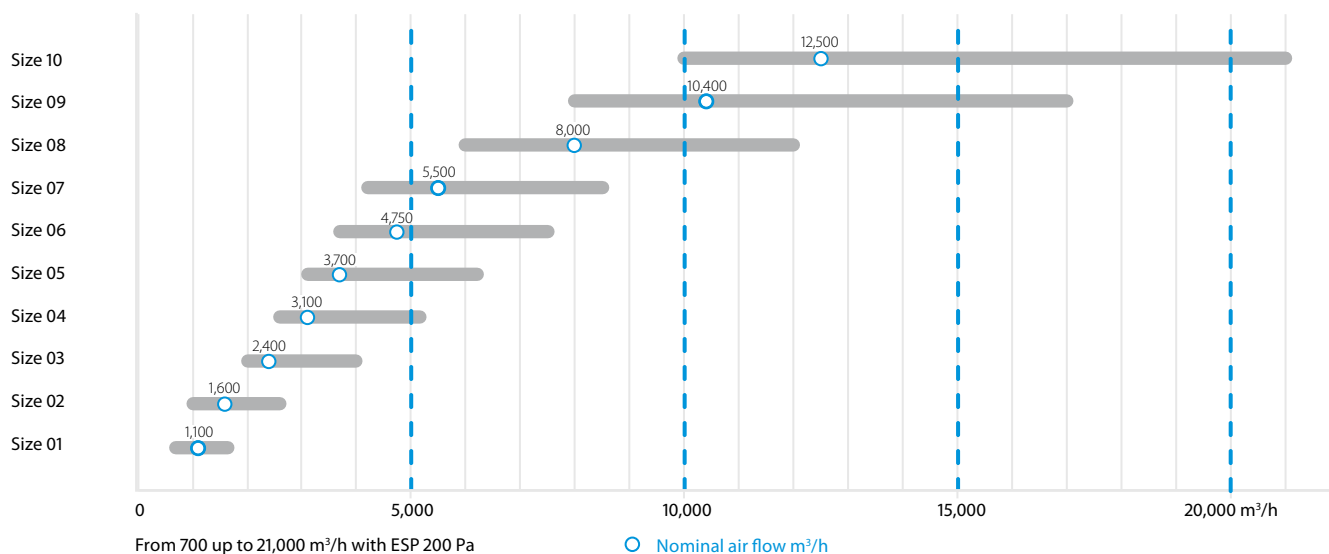

Technical details

More details and final information can be found by scanning or clicking the QR codes.



Modular P

Modular P			1	2	3	4	5	6	7	8	9	10		
Airflow	m ³ /h		1,100	1,600	2,400	3,100	3,700	4,750	5,500	8,000	10,400	12,500		
Heat exchanger thermal efficiency ¹	%		88.1	87	87.2	87.1		92.1		91.8	92.9			
External static pressure	Nom.	Pa	200											
Current ²	Nom.	A	1.78	2.48	2.08	2.73	3.45	4.58	5.25	7.53	9.55	11.55		
Power input ²	Nom.	kW	0.41	0.57	0.83	1.09	1.38	1.83	2.10	3.01	3.82	4.62		
SFPv ³		kW/m ³ /s	1.183	1.092	1.090	1.113	1.118	1.210	1.207	1.216	1.148	1.166		
Electrical supply	Phase	ph	1				3							
	Frequency	Hz						50						
	Voltage	V	230			400								
Dimensions unit	Width	mm	720	820	990	1,200	1,400		1,600	1,940		2,300		
	Height	mm	1,320		1,540	1,740		1,920		2,180	2,460	2,570		
	Length	mm	2,030	2,200	2,610	2,660	2,800	3,210	3,340	3,840	4,060	4,190		
Weight unit		kg	343	358	512	604	785	852	964	1,449	1,700	2,071		

1. Winter design condition: Outdoor: -10°C, 90% Indoor: 22°C, 50% | 2. Measured with dirty filters | 3. SFPv is a parameter that quantifies the fan efficiency (the lower it is, the better will be). This reduces if airflow decreases.



Modular L

False ceiling heat recovery unit

Highlights

- › 6 Predefined sizes
- › Plug & Play control solution
- › Compact unit from 280 mm height (for air flow up to 550 m³/h)
- › Wide air flow coverage from 150 to 3,400 m³/h
- › Right and left configuration
- › Pro (open control platform) and Smart (Daikin control platform) version
- › Excellent indoor air quality (IAQ). Up to ePM1 80% (F9) filtration level with possibility to have a prefilter up to ePM1 50% (F7) for the best IAQ
- › VDI 6022 Certified
- › BIM file available at www.daikin.eu/BIM

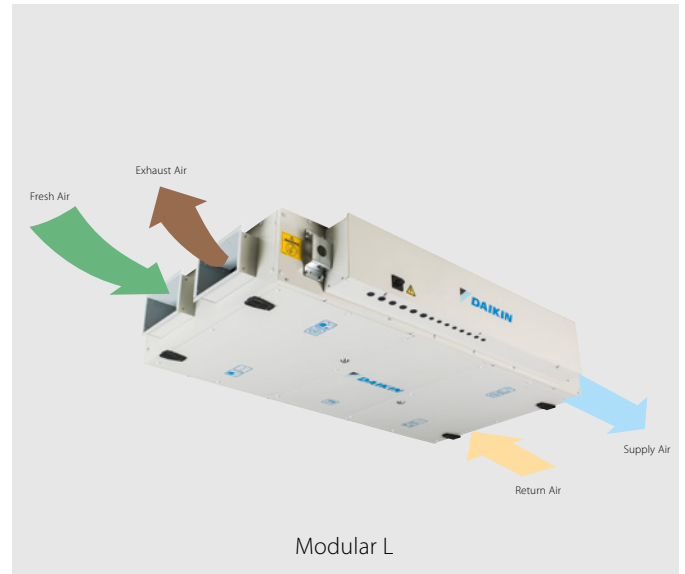

For integration with Sky Air and VRV units, please refer to the Modular L Smart, in the Ventilation chapter

Air flow range

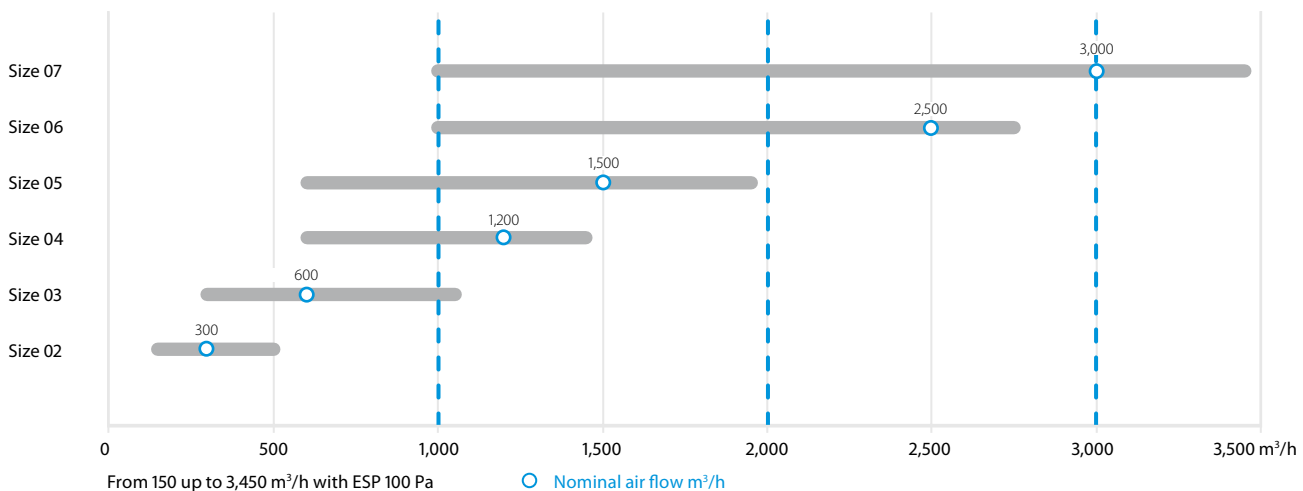

Technical details

More details and final information can be found by scanning or clicking the QR codes.



Modular L

Modular L			ALB02*B	ALB03*B	ALB04*B	ALB05*B	ALB06*B	ALB07*B
Airflow	m ³ /h		300	600	1,200	1,600	2,500	3,000
Heat exchanger thermal efficiency ¹	%		90		91	90	91	90
External static pressure	Nom. Pa		100					
Current	Nom. A		0.61	1.39	2.26	2.87	5.17	6.26
Power input	Nom. kW		0.14	0.32	0.52	0.66	1.19	1.44
SFPv ²	kW/m ³ /s		1.27	1.55	1.32	1.38	1.49	1.54
Electrical supply	Phase	ph	1					
	Frequency	Hz	50/60					
	Voltage	V	220/240 Vac					
Main unit dimensions	Width	mm	920	1,100	1,600		2,000	
	Height	mm	280	350	415		500	
	Length	mm	1,660	1,800	2,000			
Rectangular duct flange	Width	mm	250	400	500		700	
	Height	mm	150	200	300		400	
Weight unit	kg		125	180	270	280	355	360

1. Winter design condition: Outdoor: -10°C, 90% Indoor: 22°C, 50% | 2. SFPv is a parameter that quantifies the fan efficiency (the lower it is the better will be). This reduces if airflow decreases.
 3. Electrical current is based on 230V | 4. All data in the table refer to Modular L Pro. For Modular L Smart can be different. Please refer to Databook or Astra selection software for more details.

Modular T

Top connected heat recovery unit

Highlights

- › 5 Predefined sizes
- › Plug & Play control solution
- › Compact unit from 550 mm width (for unit up to 1,100 m³/h)
- › Wide air flow coverage from 200 to 4,200 m³/h
- › Right and left configuration
- › Pro (open control platform) and Smart (Daikin control platform) version
- › Excellent indoor air quality (IAQ). Up to three filtration stages: more than 90% PM1 in outdoor air are deleted achieving the best IAQ
- › DX and water coil available as option
- › Recirculation mixing damper (option)
- › BIM file available at www.daikin.eu/BIM



Air flow range

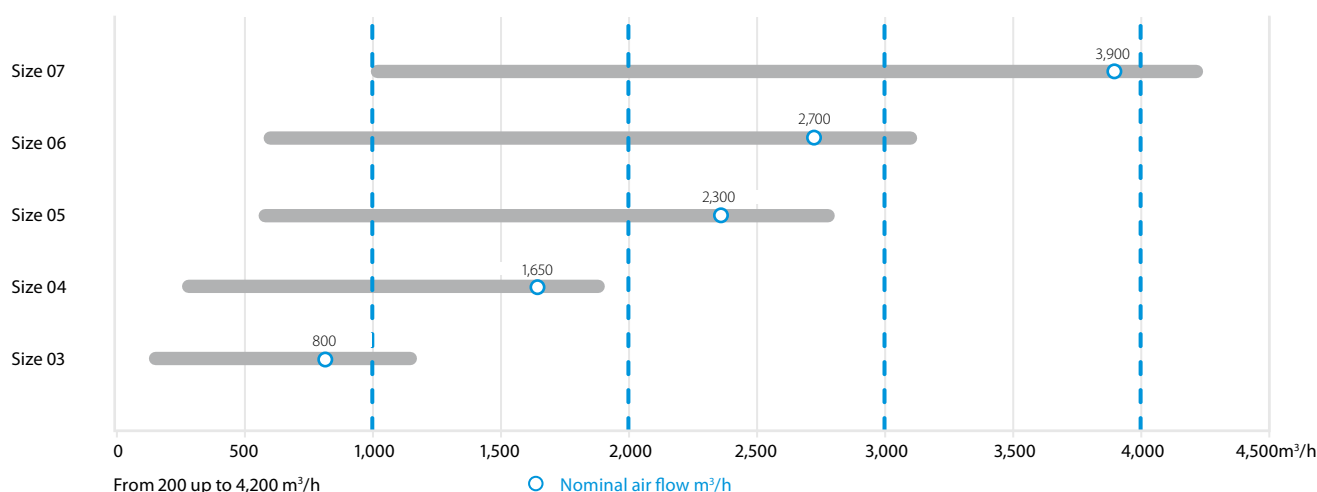

Technical details

More details and final information can be found by scanning or clicking the QR codes.



Modular T

Modular T		ATB03*A*	ATB04*A*	ATB05*A*	ATB06*A*	ATB07*A*
Size ¹		03	04	05	06	07
Airflow	m ³ /h	800	1,650	2,300	2,700	3,900
Heat exchanger thermal efficiency ²	%	89.3	88.3	85.1	85.5	90.8
External static pressure	Pa			100		
Current	A	1.70	3.39	4.61	5.17	7.87
Power input	kW	0.39	0.78	1.06	1.19	1.81
SFPv ⁵	kW/m ³ /s	1.47	1.5	1.49	1.41	1.5
Electrical supply	Phase	1				
	Frequency	50/60				
	Voltage	220/240 Vac				
Main unit dimensions	Width	550	790	790	790	890
	Height	1,600				
	Length	1,580	1,650	2,170 ⁴	2,620 ⁵	2,950 ⁵
Circular duct flange	Diameter	255	315	355	400	500
Unit sound power level	dBA	57	52	55		58
Unit sound pressure level ⁶	dBA	50	45	48		51
Weight Unit	Kg	200	250	400	500	620

1. All size available in Smart or Pro version and right or left handing | 2. Outdoor condition: -5°C, 90% Indoor condition: 25°C, 50% | 3. Including feet and duct connections | 4. Size 05 is provided in two sections
5. Size 06 and 07 are provided in three sections | 6. Simple source reference value at 1 meter, directivity factor Q=4 (quarter sphere) and non-reverberant field. Allowances on declared values: +/- 3dB

Daikin fresh air package



Plug and play connection of AHU to Daikin VRV and ERQ

The Daikin fresh air package provides a complete solution, including all unit controls (expansion valve, control box and AHU controller) and sensors factory mounted and configured.

Higher efficiency

Daikin heat pumps are renowned for their high energy efficiency. Integrating the AHU with a heat recovery system is even more effective since an office system can frequently be in cooling mode while the outdoor air is too cold to be brought inside in an unconditioned state. In this case heat from the offices is merely transferred to heat up the cold incoming fresh air.

High comfort levels

Daikin ERQ and VRV units respond rapidly to fluctuations in supply air temperature, resulting in a steady indoor temperature and resulting in high comfort levels for the end user. The ultimate is the VRV range which improves comfort even more by offering continuous heating, also during defrost.

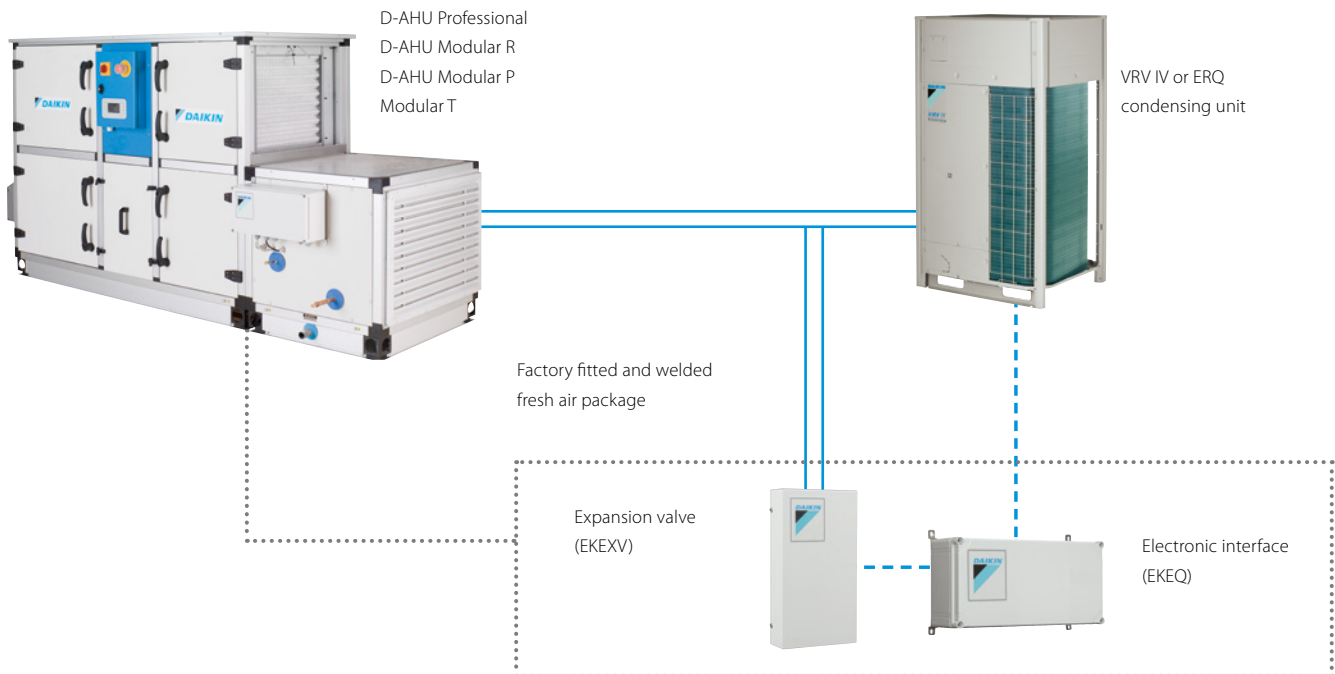

For more information on the connection of VRV or ERQ DX units with air handling units refer to the chapter Commercial ventilation & air purification of this catalogue



