

Ventilation

Product catalogue 2020
for professionals



Fresh air for the residential and commercial sector
Heat recovery ventilation and air handling applications

Advantages

With this interactive PDF we want to ensure you quickly find back the information you are looking for. Within this catalogue or via direct links to our business portal. Focus on your business, we are here to help you.

We need your feedback

Fill out 5 simple questions to help us improve this catalogue. We've put these questions on an online link, so we can easily process all surveys continuously.

TAKE THE ONLINE SURVEY »

Navigation



Sidebar links

The different chapters in the catalogue are shown at the side. You will be taken directly to the index page of the with a single click.

All page numbers clickable

Click any page number you see and you will go directly to the page.

HRV - Heat recovery ventilation	13
> High efficiency	14
> High indoor air quality	16
> Maximum flexibility	19
> Specifications	22

Links to technical documentation

On the pages with technical drawings you can click the button above to get access to all technical drawings available for the product.

**VIEW ALL TECHNICAL DRAWINGS
ON MY.DAIKIN.EU**

Click to go back





MODULAR L (SMART)



D-AHU MODULAR R

Table of contents

The widest ventilation range on the market	4
ERV / HRV - Energy/Heat recovery ventilation units	9
› Modular L Smart (ALB-RBS/LBS)	
› VAM-FC9 / J	
› VKM-GB(M)	
Condensing units for AHU	29
Options & accessories	42
Tools and platforms	49
Technical drawings	57

5 reasons why Daikin's ventilation range is unique in the market

1 Market leading controls & connectivity

- › Interlock of ventilation and air conditioning system
 - Control ERV/HRV and air conditioning from the same controller
 - Aligns the operation mode between the systems to save energy
- › Easy integration in the total solution
 - Online control and monitoring via the Daikin Cloud Service
 - Full portfolio integration in the intelligent Touch Manager, Daikin's cost-effective mini BMS
- › User-friendly controller with premium design
 - Intuitive touch button control

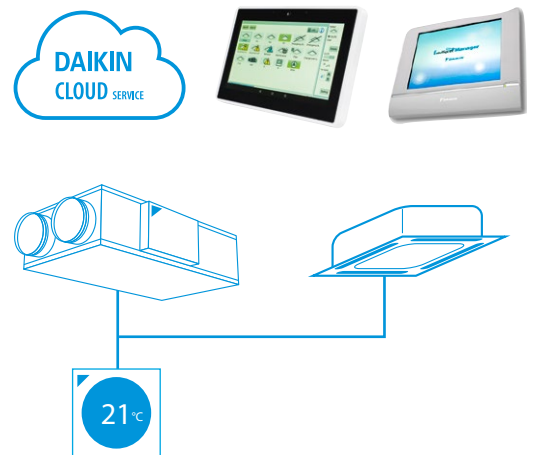

Madoka



red dot award 2018 winner

2 Unique installation benefits

- › Integrates seamlessly in the Daikin total solution, ensuring a single point of contact
- › Total fresh air solution with Daikin supplying both the VAM/Modular L Smart and the electrical heater
- › Daikin AHU and condensing unit connect Plug & Play thanks to same pipe diameters, factory mounted controls, expansion valves, etc.





3 High energy efficiency

- › Energy recovery of up to 92%, reducing running costs
- › Free nighttime cooling using fresh outside air
- › Inverter driven centrifugal fans
- › ErP compliant



4 Best comfort

- › Wide range of units to control fresh air and humidity
- › Wide range of optional filters to suit the application available up to ePM₁ 80% (F9)
- › Special paper heat exchanger recovers heat and moisture from extract air to warm up and humidify fresh air to comfortable levels (VAM, VKM)



5 Top reliability

- › Most extensive testing before new units leave the factory
- › Widest support network and after sales service
- › All spare parts available in Europe



Did you know?

CO₂ levels and ventilation rates all have significant, independent impacts on cognitive function:

COGNITIVE FUNCTION SCORES ...



+ 61%
IN GREEN BUILDING
CONDITIONS



+ 101%
IN ENHANCED
GREEN BUILDING CONDITIONS

Widest range of DX integrated ventilation on the market

Daikin offers a variety of solutions from small energy recovery ventilation to large-scale air handling units for the provision of fresh air ventilation to homes, or commercial premises.

Ventilation solutions

Daikin offers state-of-the-art ventilation solutions that can easily be integrated into any project:

- › **Unique portfolio** within DX manufacturers
- › High-quality solutions complying with the **highest Daikin quality standards**
- › **Seamless integration** of all products to provide the best indoor climate
- › All Daikin products connected to a single controller for **complete control** of the HVAC system.

Energy Recovery Ventilation

Our energy recovery units **recover sensible energy** (Modular L Pro / Modular L Smart) or **total (sensible + latent) energy** (VAM/VKM), substantially reducing the load on the air conditioning system up to 40%.

Ventilation with DX connection - Control over fresh air temperature

Daikin offers a range of inverter condensing units to be used in combination with Daikin AHUs for ultimate control over the fresh air. There are 4 control possibilities when **combining AHU and Daikin outdoor units** hence offering all the required flexibility for any installation. Indoor units can be combined to the same outdoor unit to reduce the installation costs. For **false-ceiling installations** where space is a constraint, the VKM can fit perfectly to deliver fresh air at a comfortable temperature and it has an optional humidification element.

Five components of indoor air quality

- › **Ventilation:** Ensures the provision of fresh air
- › **Energy recovery:** Delivers energy savings by transferring heat and moisture between airflows
- › **Air processing:** Delivers the right supply temperature to decrease the indoor unit load
- › **Humidification:** Ensures relative indoor humidity levels are respected
- › **Filtration:** Separates pollen, dust and pollution odours that are harmful to individuals' health

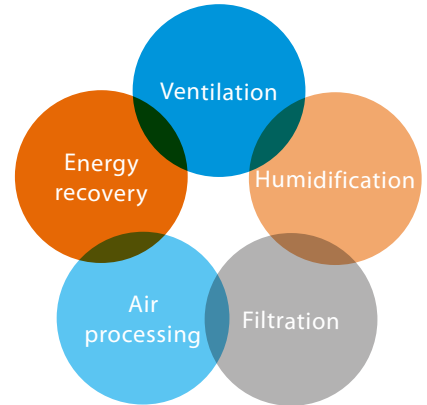

Fresh air portfolio

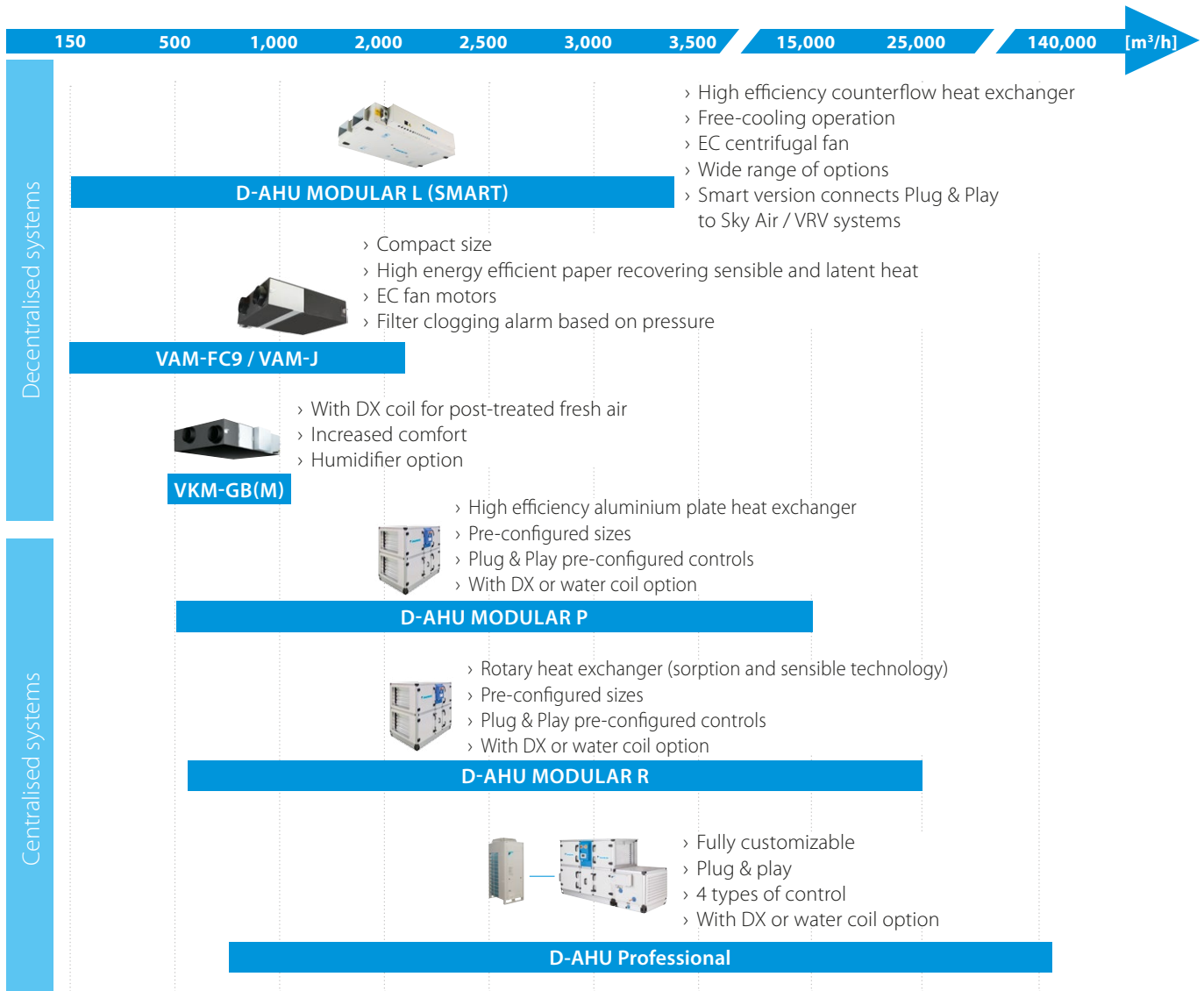



Direct integration into the Sky Air or VRV control solution

- › Saves up to 40% in running costs
- › Unified control point for the complete air conditioning and ventilation installation

Wide range of decentralised ERV/HRV units to suit the building needs

Energy / Heat Recovery Ventilation

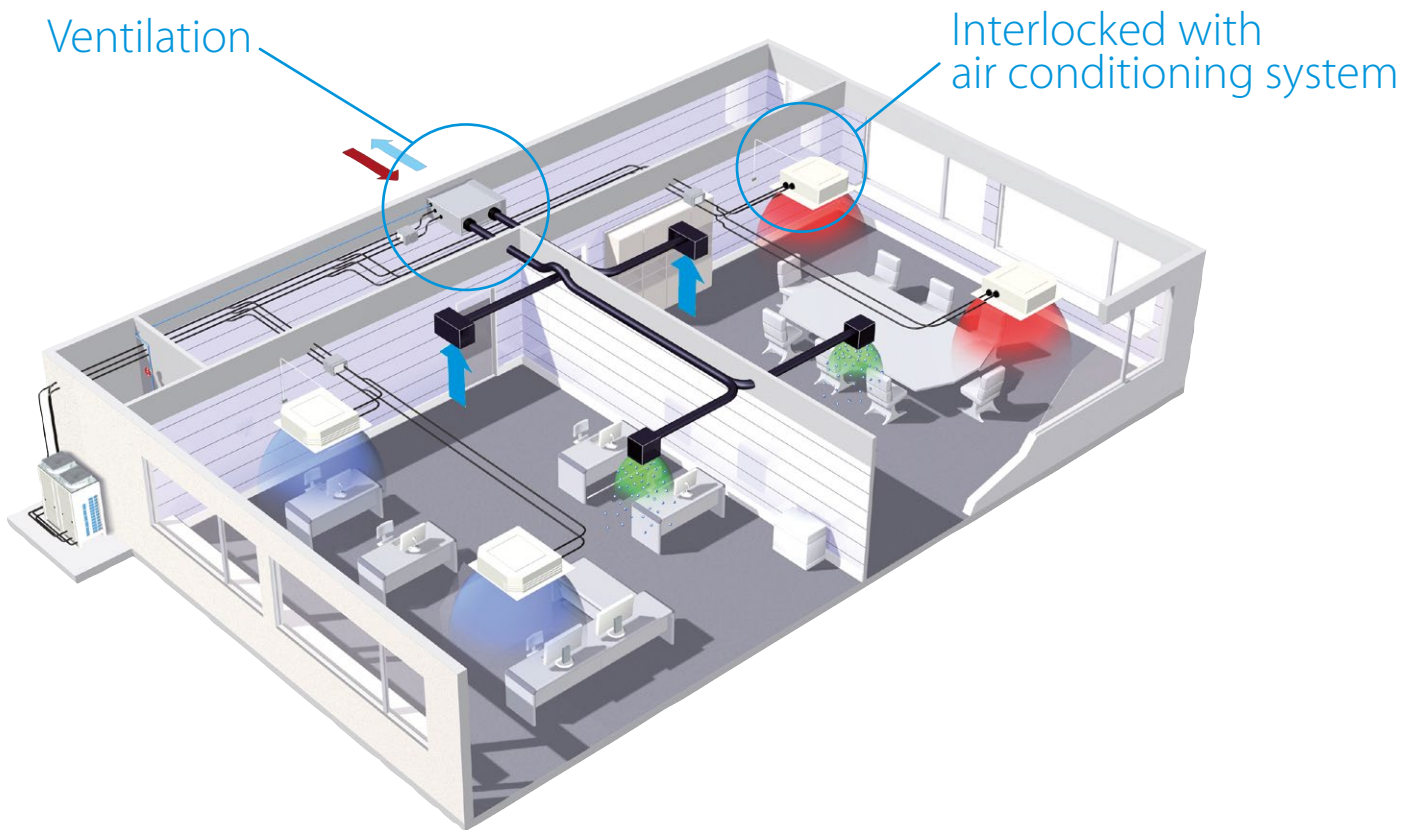

**Premium efficiency heat recovery unit
Modular L (Smart) (ALB-(RBS/LBS))**

17

- > Heat recovery unit
- > Counter flow plate heat exchanger
- > ESP up to 600 Pa
- > Operates as stand-alone or combined with Sky Air or VRV systems



Energy recovery ventilation (VAM-FC9/J)

22

- > Heat and moisture recovery
- > Achieve free cooling with fresh outdoor air
- > Operates as stand-alone or combined with Sky Air or VRV systems



**Energy recovery ventilation with humidification
and air processing (VKM-GB(M))**

22

- > Heat and moisture recovery
- > Humidification and air processing (preconditioning) of fresh air
- > Achieve free cooling with fresh outdoor air
- > Plug & Play piping and wiring connection with Daikin VRV unit(s)



Benefits of
Daikin ERV/HRV systems

1 Market leading controls & connectivity

Interlock of the ventilation operation with the air conditioner operation

Interlock of the ventilation operation with the air conditioner operation greatly simplifies overall system control. The same remote controller provides air conditioning and ventilation functions.

By incorporating a variety of centralised control equipments, the user can build a large, high grade centralised control system.

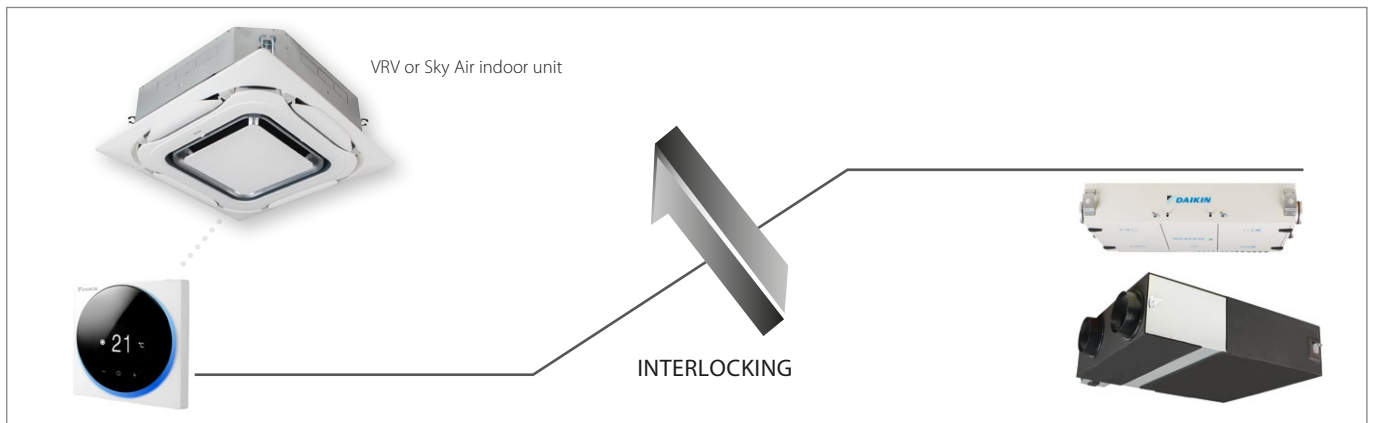

Madoka

User-friendly wired remote controller with premium design



BRC1H519W7/S7/K7

- › Sleek and elegant design
- › Intuitive touch button control
- › 3 color versions
- › Advanced settings and monitoring can be easily done via your smartphone
- › Flat back for easy wall installation
- › Compact to fit standard size socket boxes



reddot award 2018 winner

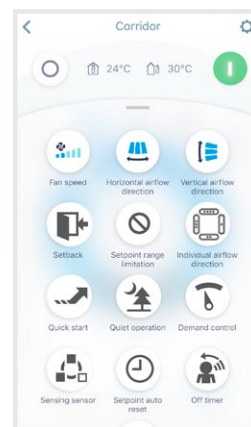

Advanced user settings

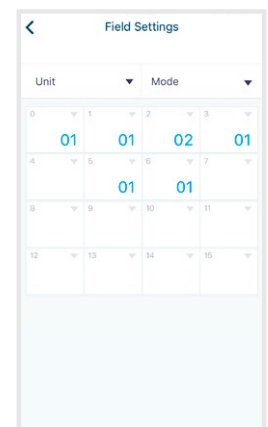

Field settings

Plug & Play - integrated ventilation

- › One-stop shop for all system components, which results in streamlined design and business solutions.
- › Efficient project follow-up, installation and subsequent commissioning and maintenance.
- › Ventilation easily interlocked to air conditioner operation thanks to simplified system control.



2 Easy and flexible installation

High Static Pressure

External static pressure (ESP) up to 600 Pa (ALB) facilitates the use of ducts of varying lengths.

Automatic Airflow Adjustment function

Automatically selects the most appropriate fan curve to achieve the units' nominal air flow within $\pm 10\%$.

Why?

After installation the real ducting will frequently differ from the initially calculated air flow resistance \rightarrow the real air flow may be much lower or higher than designed.

The airflow Adjustment function will automatically adapt the unit's fan speed to any ducting automatically (45 fan curves are available on every model (ALB/VAM)), making installation much faster.

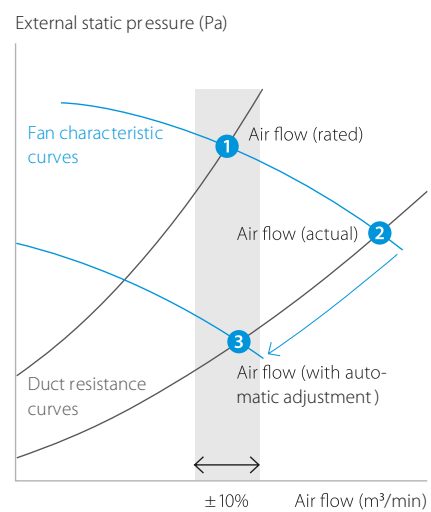

Wide operation range

The ERV/HRV unit can be installed practically anywhere. The standard operation range (outdoor temperature) is from -15°C to 40°CDB for VKM units, from -10°C ($+5^{\circ}\text{C}$ in case of upside-down installation) to 46°CDB for VAM units, and can be extended down if a Daikin heater is installed.

¹ Contact your local dealer for more information and restrictions



Optional heater for VAM



Optional heater for Modular L Smart

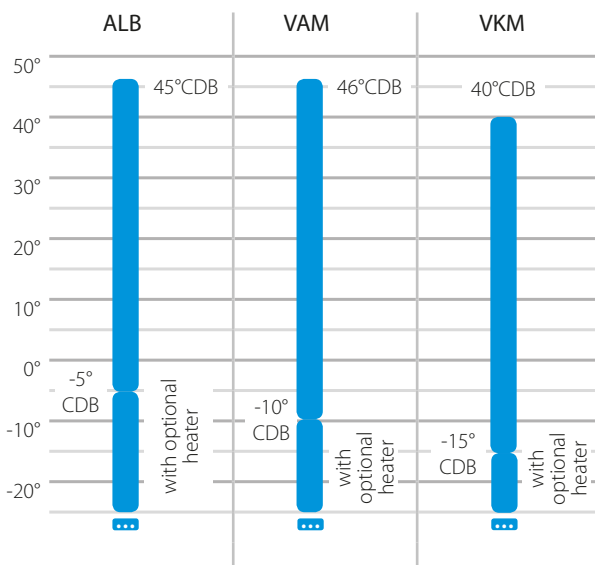
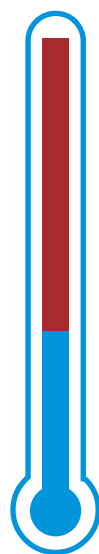

Flexible installation

Slim Design

At just 280 mm high, the slim design of the HRV unit enables it to be mounted in narrow ceiling cavities and irregularly shaped spaces

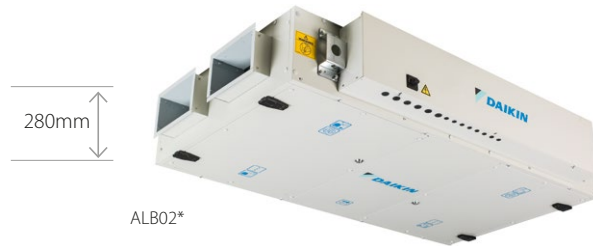

Flexible

Compared to a standard air handling unit, the HRV models provide much greater flexibility to match the actual building use, in case of a multi-tenant installation. Additionally, the renovation of a building can be carried out in phases.

ERV/HRV model:

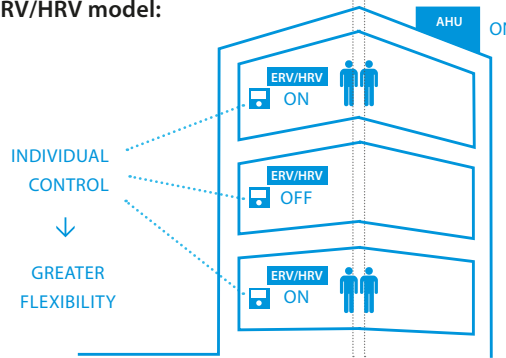

Standard air handling unit:

CENTRAL CONTROL

“Super Wiring” System

A Super Wiring system is used to enable the shared use of wiring between indoor units, outdoor units and the centralised remote control. This system makes it easy for the user to retrofit the existing

system with a centralised remote control, simply by connecting it to the outdoor units. Thanks to a non polarity wiring system, incorrect connections are avoided and installation time is reduced.

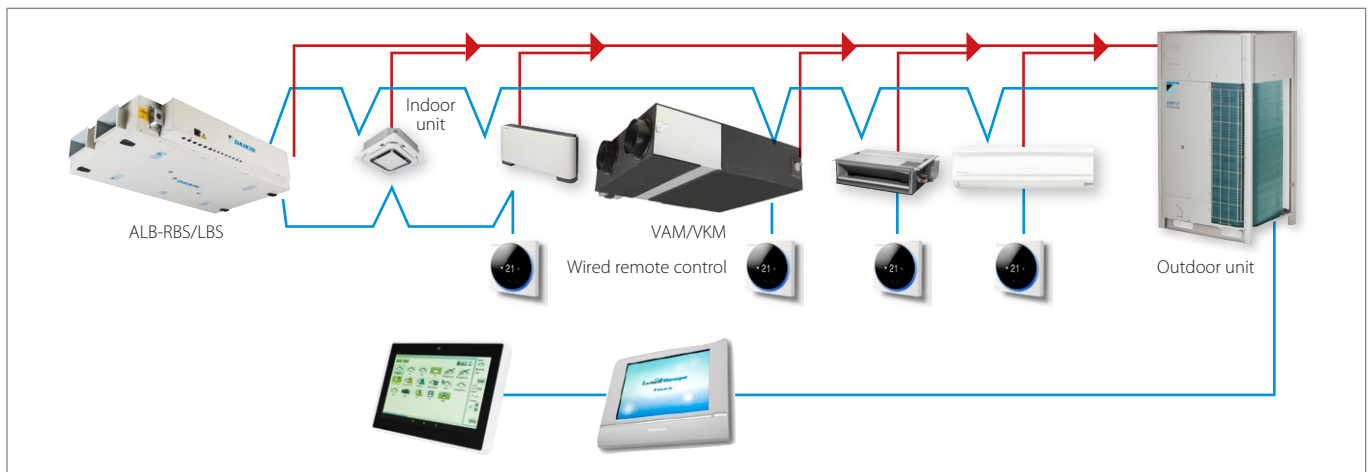

Connection to field-supplied booster fan increases flexibility even more

- > Longer ducting or use of central duct possible
- > Overcomes actual field situation when ducting is different from calculation
- > Lower cost by using the booster fan instead of replacing with a larger unit when the ESP is not matched

Example when HRV ESP is not high enough or field situation differs from calculation

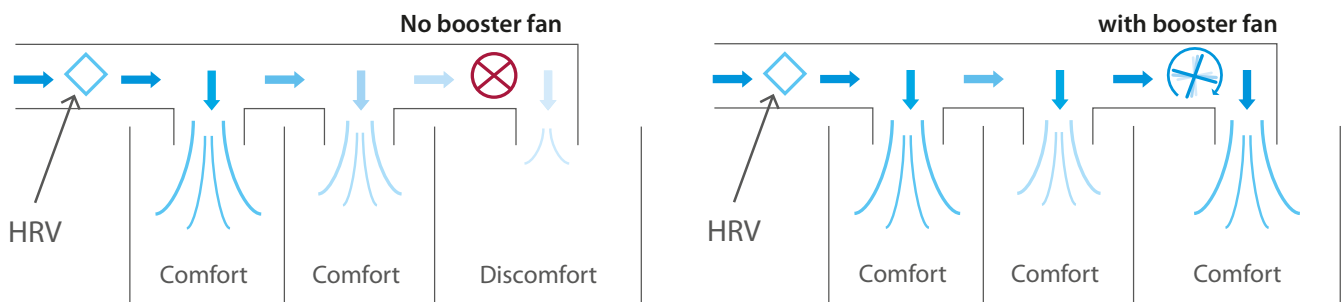

3 High efficiency

Energy saving ventilation via heat recovery of both heat and humidity

Recovers up to
92%
of wasted energy

Daikin's ERV/HRV solutions prevent energy being wasted by recovering up to 92% waste heat from the extract air instead of simply expelling the heat, offering high energy efficiency.



ALB-RBS/LBS

Reduce the load on the air conditioning system by up to 40%

- > 24% by using heat recovery ventilation (in comparison with normal ventilation fans)
- > 6% by switching over to auto-ventilation mode
- > 2% by using the pre-cool, pre-heat control (reduces air conditioning load by running the HRV unit after the air conditioning is switched on)
- > 5% by enabling the free cooling operation overnight
- > 3% by preventing over-ventilation with the optional CO₂ sensor

Different operation modes of ERV/HRV units

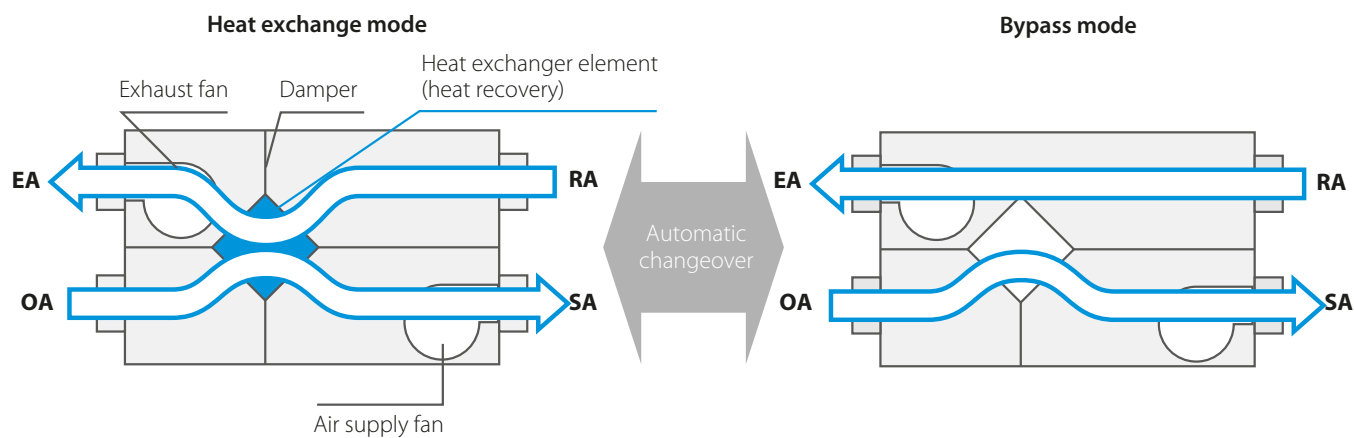

EA: Exhaust air RA: Return air (from room) OA: Outdoor air SA: Supply air (to room)

Nighttime free cooling

Nighttime free cooling operation is an **energy saving function operating at night** when the air conditioning is switched off. By ventilating rooms containing office equipment that increases room temperature,

free cooling reduces the cooling load when air conditioning is switched on in the morning, reducing the daily running costs.

The VAM and Modular L Smart can also perform nighttime free cooling in stand alone operation. The set temperature is a field setting at installation.

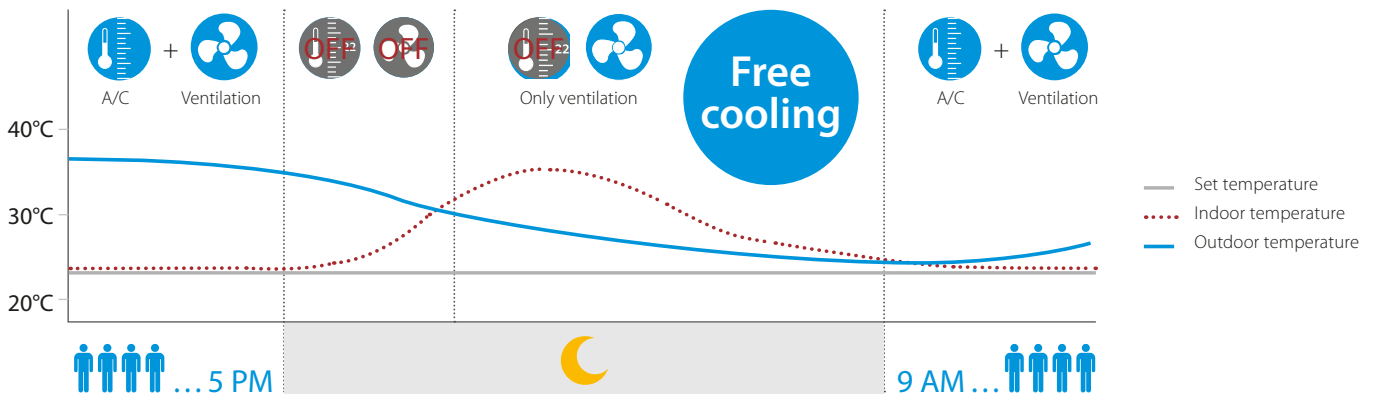

Prevent energy losses from over-ventilation with CO₂ sensor

Enough fresh air is needed to create an enjoyable environment, but ventilating constantly is leading to energy waste. Therefore an optional CO₂ sensor

can be installed which switches off the ventilation system when there is enough fresh air in the room, thus saving energy.

Example of CO₂ sensor operation in a meeting room:

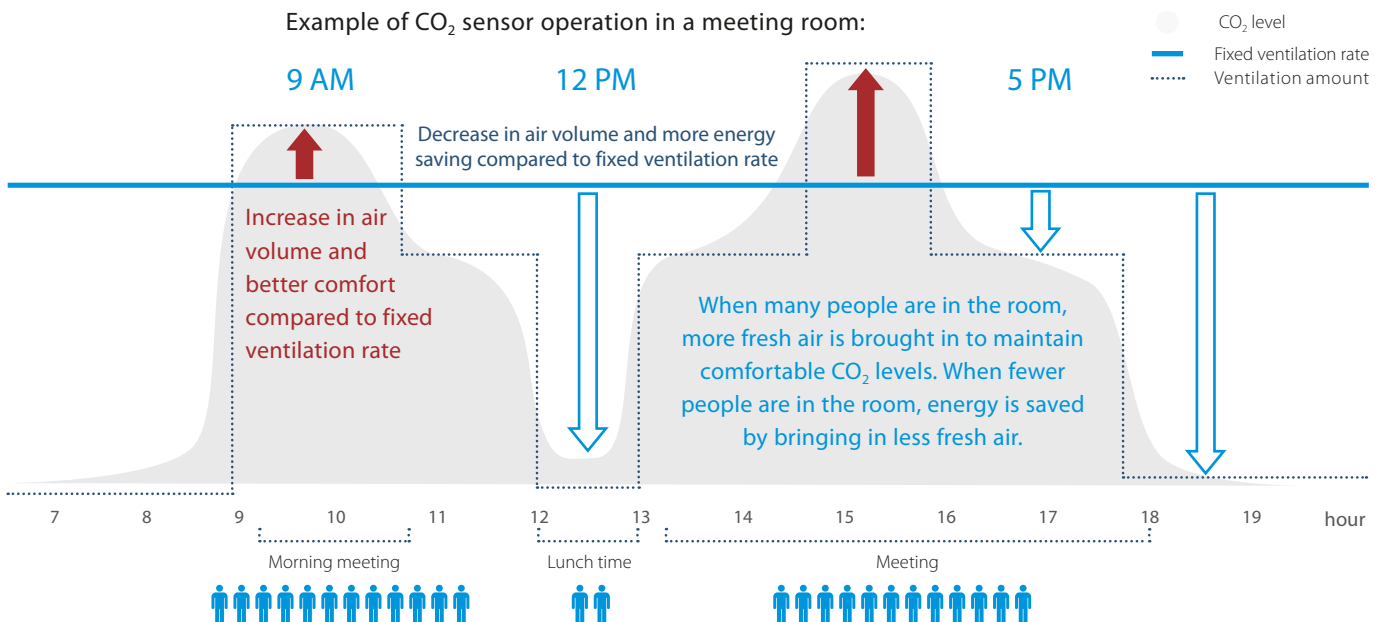

Up to 75% less energy consumed for ventilation in Herten building

A two-year test at a 'netZero Energy Building' in Herten has revealed that a huge energy saving is possible by using CO₂ sensors in conjunction with the Daikin VAM systems.

4 Best Comfort

- High quality indoor air
- Whisper quiet

Optional medium and fine dust filters available

Optional filters up to ePM₁, 70% (F8) for VAM and ePM₁, 80% (F9) for ALB are available to meet your customer request or the local legislation.



The optional filter comply with ISO 16890

Can operate in over and underpressure to prevent unpleasant odours

The user can select 2 fresh-up modes via the remote control for a more comfortable air environment.

1. Supply rich mode (overpressure):

A higher air supply than air exhaust maintains proper room pressure to prevent back-flow of toilet/kitchen odours or moisture inflow.

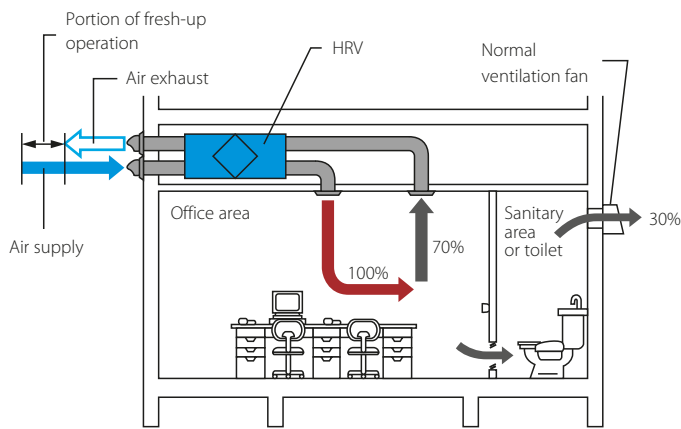

eg. Office
Preventing that toilet odours flow to the office.

2. Exhaust fresh-up (underpressure):

A higher exhaust air than air supply decreases room pressure to prevent the leaking of odours or floating bacteria and viruses into other rooms.

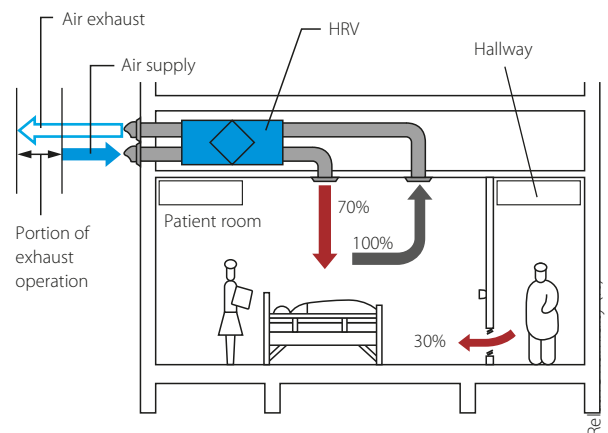

eg. Hospital
No bacteria can flow from the patient room to the hallway.

Low operation sound level

Continuous research by Daikin into reducing operation sound levels has resulted in sound pressure levels down to 20.5dBA (VAM150).

Daikin ERV/HRV unit →

DBA	PERCEIVED LOUDNESS	SOUND
0	Threshold of hearing	-
20	Extremely soft	Rustling leaves
40	Very soft	Quiet room
60	Moderately loud	Normal conversation
80	Very loud	City traffic noise
100	Extremely loud	Symphonic orchestra
120	Threshold of feeling pain	Jet taking off

Modular L Smart

Premium Efficiency Heat Recovery Unit



ALB-RBS/LBS

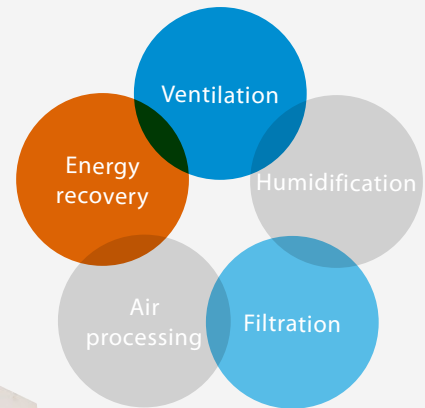

Highlights

- › Connects Plug&Play into the Sky Air and VRV control network
- › Easy installation and commissioning
- › Internal pre-filter stage (up to ePM₁ 50% (F7) + ePM₁ 80% (F9)) making the unit reach highest indoor air quality requirements.
- › Wide air flow coverage from 150m³/h to 3,450m³/h
- › Exceeding ErP 2018 requirements
- › Best choice when compactness is needed (only 280 mm height up to 550 m³/h)
- › 50 mm double skin panel (120 kg/m³) for a maximum sound and thermal insulation

EC centrifugal fan

- › Maximum ESP available 600 Pa (depending on model sizes and airflow)
- › Inverter driven with IE4 premium efficiency motor
- › High-efficient blade profiling
- › Reduced energy consumption
- › Optimized SFP (Specific Fan Power) for an efficient unit operation

Heat exchanger

- › Premium quality counter flow plate heat exchanger
- › Up to 92% of the thermal energy recovered
- › High grade aluminum allowing optimum corrosion protection



Premium quality to meet most sophisticated needs



Heat exchanger

- › Premium quality counterflow plate heat exchanger
- › Up to 92% of the thermal energy recovered
- › High grade aluminium that allows best corrosion protection
- › Completely joint sealing
- › No screws or rivets in any part

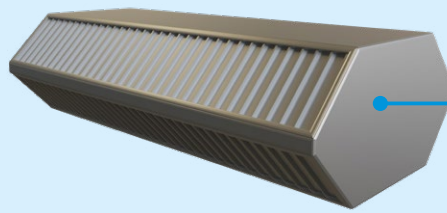

Filters

- › Easy replaceable compact filters with large surface area, which can be removed from bottom access
- › Up to ePM₁ 50% (F7) + ePM₁ 80% (F9) filtration efficiency
- › No tools are needed to change the filters
- › Fresh air filters* (ePM₁ 50% (F7) efficiency as standard)
- › Return filters* (ePM₁₀ 75% (M5) efficiency as standard)

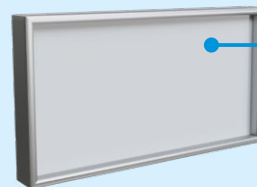

*Optional additional filter and pre-filter stage coarse 55% (G4), ePM₁₀ 75% (M5), ePM₁ 50% (F7), ePM₁ 80% (F9)



Supply/Return fan

- › Fan/motor combination with very low noise level
- › Reduced energy consumption
- › Inverter driven with IE4 motor efficiency
- › Infinitely variable speed
- › Ultra-efficient blade profiling
- › Maintenance-free ball bearings
- › No screws or rivets in any part

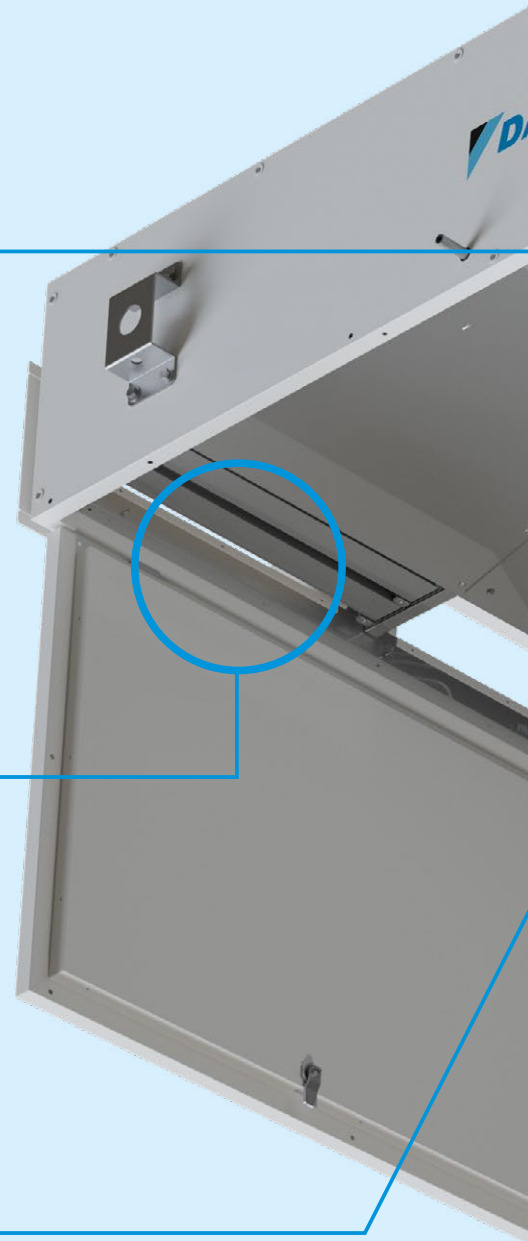

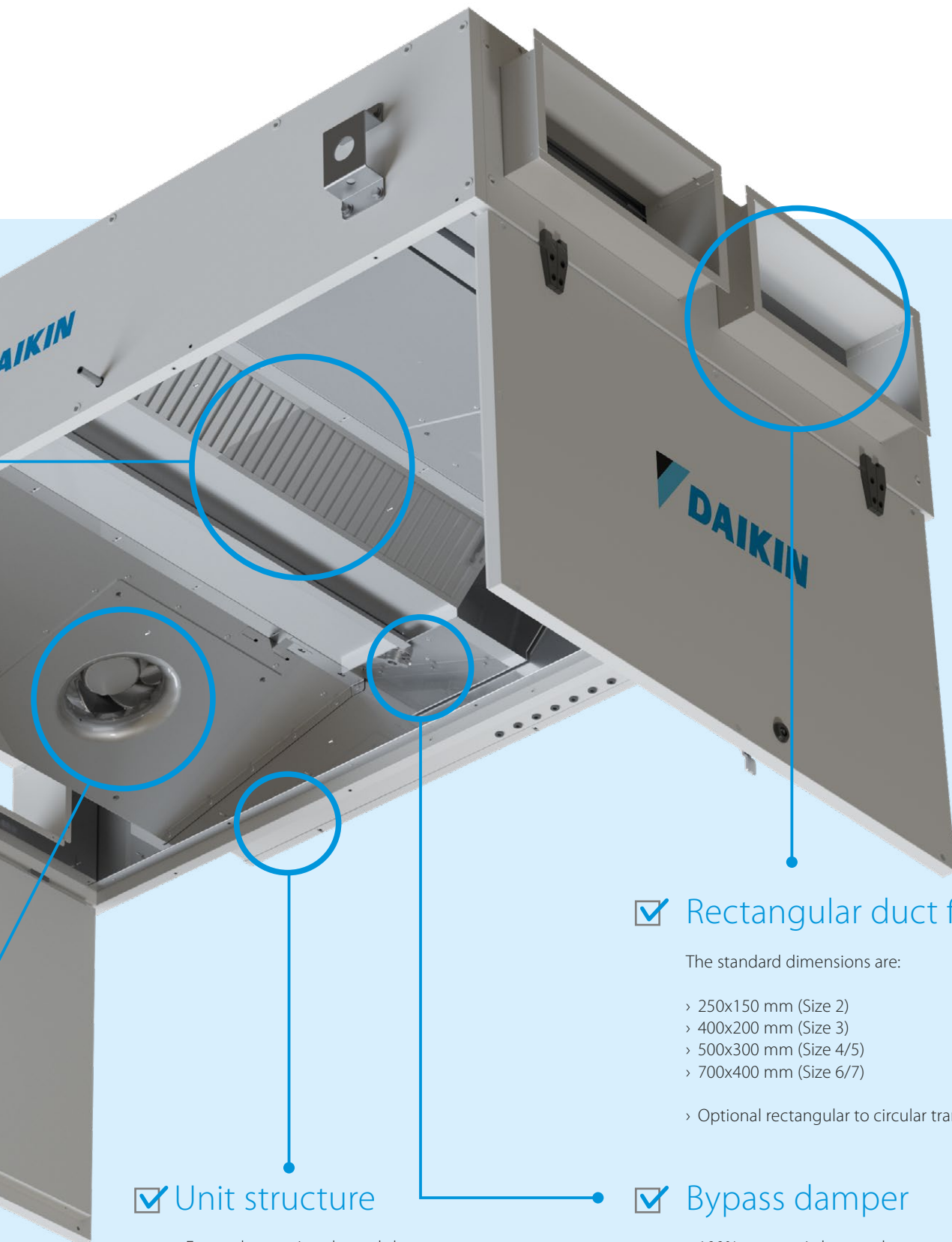

✓ Unit structure

- › External pre-painted metal sheet
- › Internal Aluzinc metal sheet
- › 50 mm Double skin panel thickness
- › Mineral wool insulated
- › Great sound absorption
- › Hinged or fully removable bottom doors make the unit easily accessible for service and maintenance
- › Unit is accessible from bottom panels
- › Best choice when compactness is needed (only 280 mm height for up to 550 m³/h of air flow)

✓ Rectangular duct flange

The standard dimensions are:

- › 250x150 mm (Size 2)
- › 400x200 mm (Size 3)
- › 500x300 mm (Size 4/5)
- › 700x400 mm (Size 6/7)
- › Optional rectangular to circular transition

✓ Bypass damper

- › 100% automatic bypass damper with proportional opening for antifreeze function and free cooling operation

✓ Full integration in the DIII network (Sky Air and VRV)

Technical details



Control logic

- › Air quality analysis with the capability of monitoring and control of the actual level of CO₂ through optional sensor (option)
- › Full automatic bypass to manage free cooling
- › Filter alarm in accordance with the EU Reg 1253
- › DIII-net integration through Daikin building air conditioning control systems (D-BACS)
- › BMS integration through dedicated interfaces (Modbus, BACnet)

Air flow range

Modular L Smart is available in 6 sizes covering a wide range of applications such as hotels, offices, schools and light commercial buildings

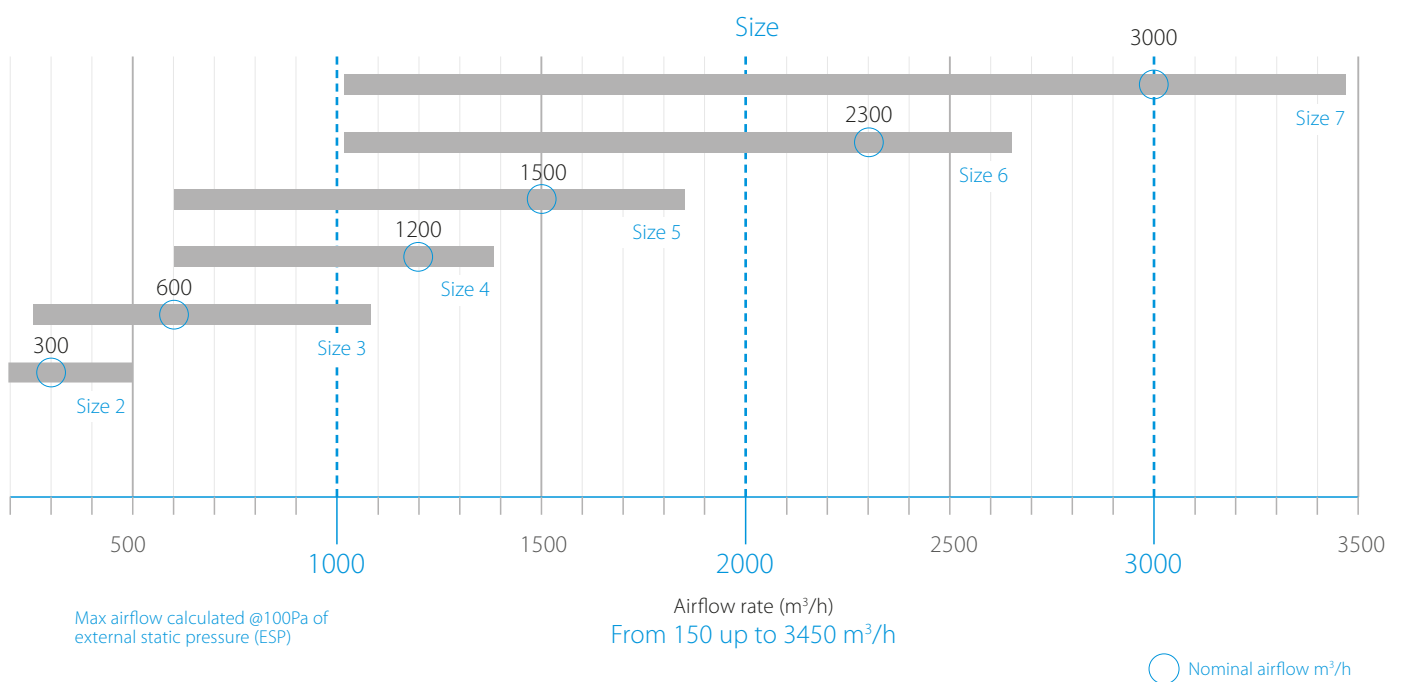



Right drain connection (ALB-RBS)



Left drain connection (ALB-LBS)

Technical details

D-AHU Modular L Smart		ALB-RBS/LBS	02	03	04	05	06	07
Airflow		m ³ /h	300	600	1200	1500	2300	3000
Heat exchanger thermal efficiency ¹		%	90	91	90	90	92	91
External static pressure	Nom.	Pa	100	100	100	100	100	100
Temperature after heat exchanger ¹	Nom.	°C	19,4	19,5	19,4	19,2	19,8	19,5
Max ESP @ nom. airflow		Pa	400	450	260	270	250	210
Current	Nom.	A	0,52	1,17	1,91	2,48	3,76	5,39
Power input	Nom.	kW	0,12	0,27	0,44	0,57	0,87	1,24
SFPv ²		kW/m ³ /s	1,24	1,49	1,28	1,32	1,32	1,46
ERP compliant			ErP 2018 Compliant					
Electrical supply	Phase	ph	1	1	1	1	1	1
	Frequency	Hz	50/60	50/60	50/60	50/60	50/60	50/60
	Voltage	V	220/240 Vac	220/240 Vac	220/240 Vac	220/240 Vac	220/240 Vac	220/240 Vac
Main unit dimensions	Width	mm	920	1100	1600	1600	2000	2000
	Height	mm	280	350	415	415	500	500
	Length	mm	1660	1800	2000	2000	2000	2000
Rectangular duct flange	Width	mm	250	400	500	500	700	700
	Height	mm	150	200	300	300	400	400
Unit Sound Power Level _(LWA)		dB	48	54	57	53	60	57
Unit Sound Pressure Level ³		dBA	34	39	41	37	44	41
Weight unit		kg	125	180	270	280	355	360

1. Winter design condition: Outdoor: -5°C, 90% Indoor: 22°C, 50%

2. SFPv is a parameter that quantifies the fan efficiency (the lower it is the better will be). This reduces if airflow decreases.

3. According to EN3744. Surrounding, Directivity (Q) = 2, @ 1,5m distance

ERV

energy recovery ventilation

Heat recovery ventilation, air processing and humidification

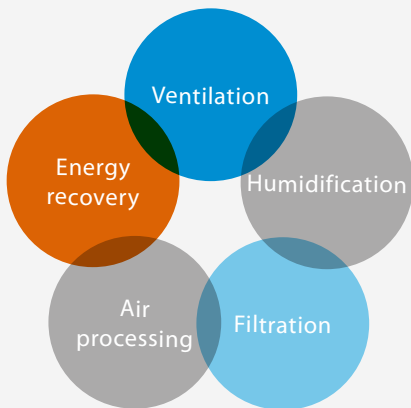

VAM-FC9 / VAM-J

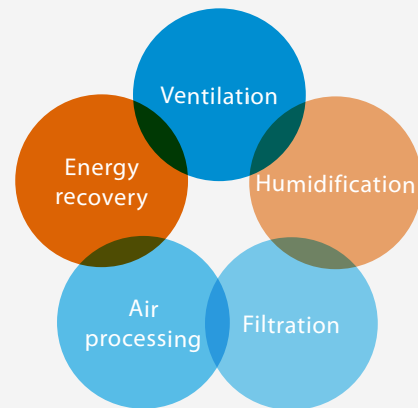

VKM-GB(M)

High efficiency

- › Energy saving ventilation via enthalpy recovery of both heat and humidity
- › Reduce the load on the air conditioning system by up to 40%
- › Nighttime free cooling
- › Prevent energy losses from over-ventilation with CO₂ sensor

High indoor air quality & whisper quiet operation

- › Optional medium and fine dust filters (VAM-FC9/J only)
- › Can operate in over and underpressure to prevent unpleasant odours
- › Low operation sound level

Maximum flexibility

- › Plug & Play - integrated ventilation
- › Flexible installation
- › Wide range of units
- › High static pressure
- › Wide operation range
- › Connection to field-supplied booster fan increases flexibility even more (VAM-FC9/J only)
- › No drain needed (VAM-FC9/J only)

Energy saving ventilation via enthalpy recovery of both heat and humidity

Recovers up to **85%** of waste heat

Daikin's ERV solutions prevent energy being wasted by recovering up to 85% waste heat from the extract air instead of simply expelling the heat, offering high energy efficiency.

Specially developed heat exchange element

The heat exchange element rapidly recovers heat contained in latent heat (vapour).

Operation of the high efficiency paper.
Cross flow of air to exchange heat and moisture.

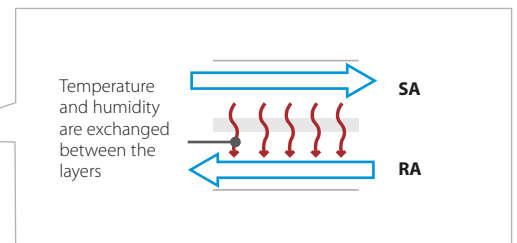
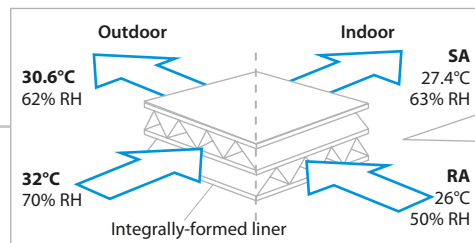
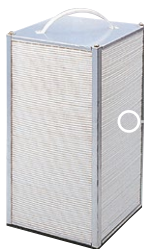

RH: Relative Humidity
SA: Supply Air (to room)
RA: Return Air (from room)

High indoor comfort

Thanks to the heat and moisture exchange, the hot and humid outside air is brought to levels close to indoor conditions saving on the air conditioning running cost and maintaining comfort.

Can be installed horizontally, upside down or vertically

The VAM models do not require a drain, giving greater flexibility for the installation of the units.

In case of upside down or vertical installation the minimum fresh air temperature is +5°C instead of -10°C.

Add a heater to reach this condition, if necessary.

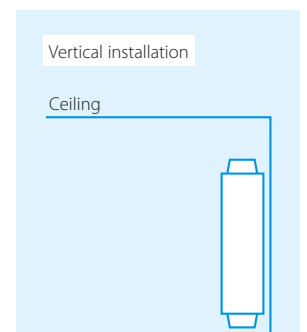
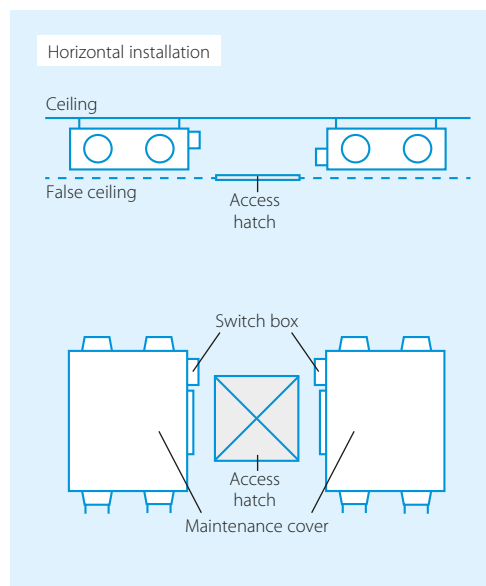

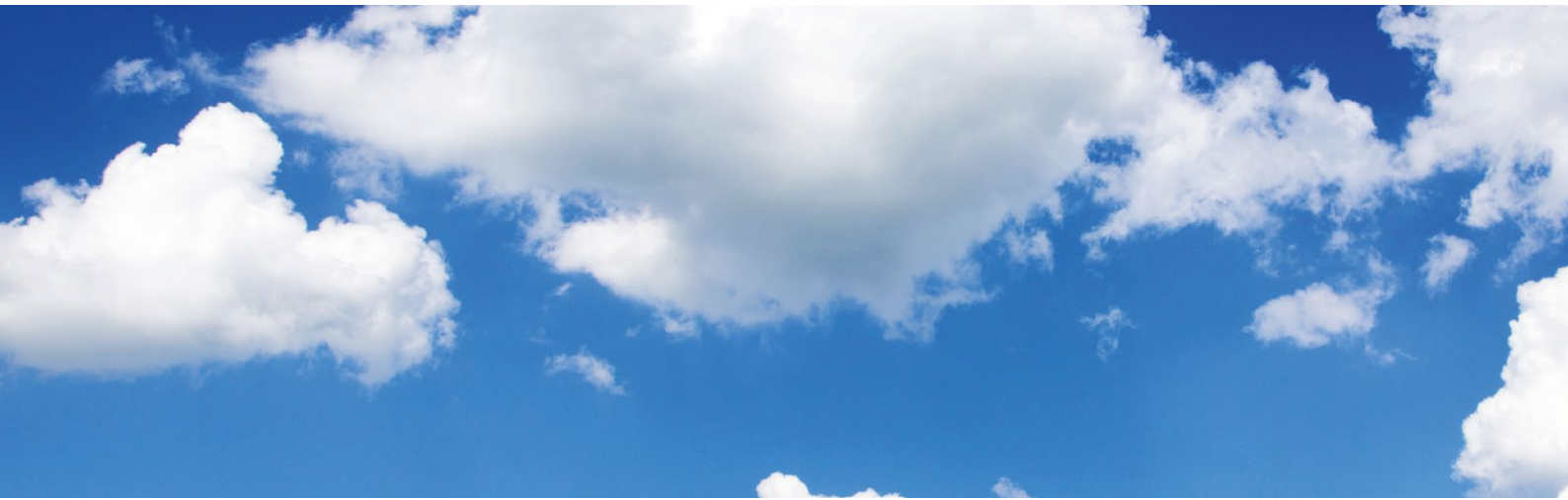

Creating a high quality environment

Maintain a comfortable indoor environment without fluctuations in room temperature.

How do the VKM units work?

In heating

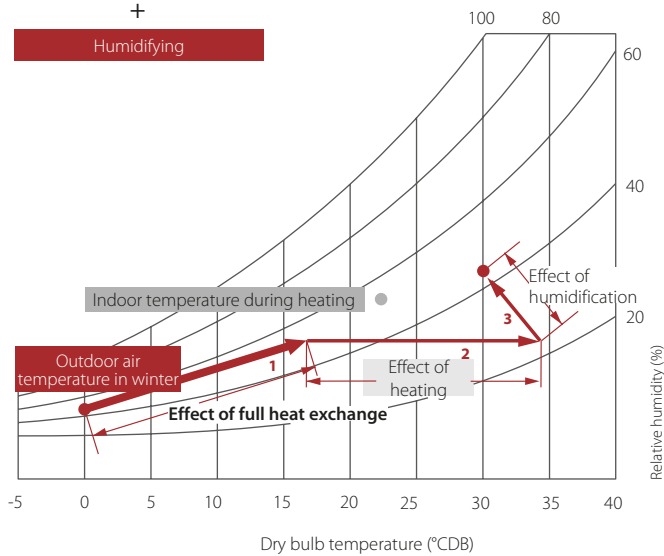

In cooling

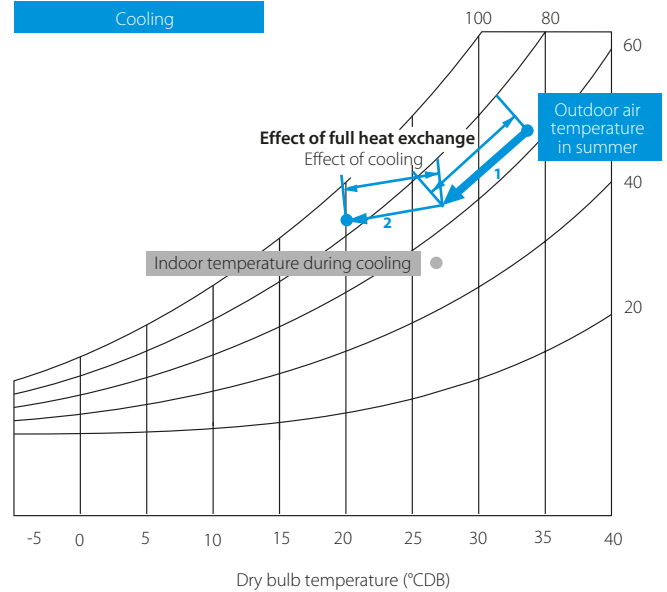
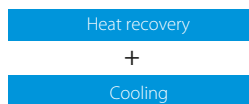

<p>In heating we bring in cold outdoor fresh air and want to avoid cold draught and dry air.</p>	<p>In cooling we bring in hot outdoor fresh air and want to prevent additional load on the air conditioning system and too hot indoor temperatures.</p>
<p>1. Cold outside air is crossed with hot inside air. In the example the fresh air is heated up from 0 to 16°CDB while keeping the same relative humidity. This is the effect of the heat and moisture exchange.</p>	<p>1. Hot outside air is crossed with cold inside air. In the example the fresh air is cooled down from 34 to 27°CDB while keeping the same relative humidity. This is the effect of the heat and moisture exchange.</p>
<p>2. The DX coil further heats up the air to prevent cold draught. In the example the fresh air is further heated from 16 to 34°CDB. Because the air is heated up the relative humidity decreases.</p>	<p>2. The DX coil further cools down the air to prevent hot indoor temperatures and reduce the load on the air conditioning system. In the example the fresh air is further cooled down from 27 to 20°CDB.</p>
<p>3. To counter negative effects of dry air the air passes the humidifier which adds moisture in case needed. In the example the relative humidity rises from 22 to a comfortable 42%.</p>	<p>3. No humidification is needed in cooling as the air is not dried out.</p>
<p>The result is fresh air with the same humidity and slightly higher temperature for perfect comfort.</p>	<p>The result is fresh air with a slightly lower temperature for perfect comfort.</p>



Humidification

Operation example: humidification & air processing (heating mode)¹

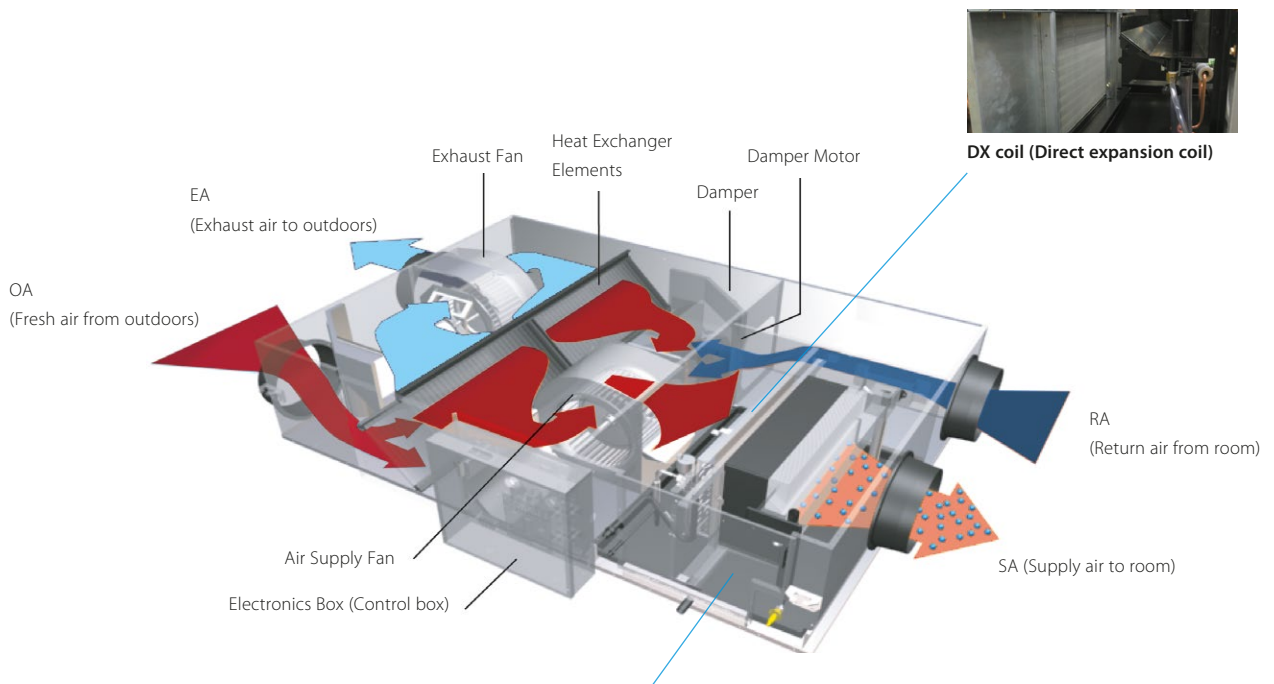

DX coil (Direct expansion coil)

Humidifier element:

Utilizing the principle of capillary action, water is permeated throughout the humidifier element. The heated air from the DX coil passes through the humidifier and absorbs the moisture.

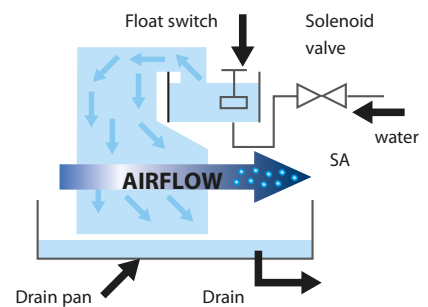

¹ VKM-GM example

Energy recovery ventilation

Ventilation with heat recovery as standard

- › Thinnest High Efficiency Enthalpy Heat Exchanger in the market (J-series)
- › Energy saving ventilation using indoor heating, cooling and moisture recovery
- › Free cooling possible when outdoor temperature is below indoor temperature (eg. during nighttime)
- › Prevent energy losses from over-ventilation while improving indoor air quality with optional CO₂ sensor
- › Possibility to change ESP via wired remote control allows optimisation of the supply air volume (J - series)
- › Can be used as stand alone or integrated in the Sky Air or VRV system
- › Wide range of units: air flow rate from 150 up to 2,000 m³/h
- › Shorter installation time thanks to easy adjustment of nominal air flow rate, so less need for dampers compared with traditional installation
- › No drain piping needed
- › Can operate in over- and under pressure
- › Total solution for fresh air with Daikin supply of both VAM / VKM and electrical heaters

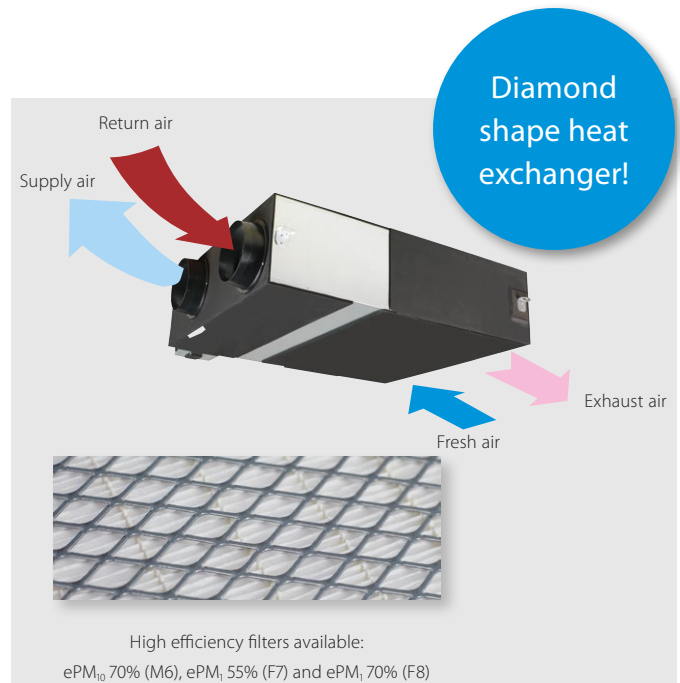

Ventilation		VAM/VAM		150FC9	250FC9	350J	500J	650J	800J	1000J	1500J	2000J				
Power input - 50Hz	Heat exchange mode	Nom.	Ultra high/High/Low	kW	0.132/0.111/0.058	0.161/0.079/0.064	0.097/0.070/0.039	0.164/0.113/0.054	0.247/0.173/0.081	0.303/0.212/0.103	0.416/0.307/0.191	0.548/0.384/0.273				
	Bypass mode	Nom.	Ultra high/High/Low	kW	0.132/0.111/0.058	0.161/0.079/0.064	0.085/0.061/0.031	0.148/0.100/0.045	0.195/0.131/0.059	0.289/0.194/0.086	0.417/0.300/0.119	0.525/0.350/0.239				
Temperature exchange efficiency - 50Hz	Ultra high/High/Low			%	770(1)/720(2)/783(1)/723(2)/82.8(1)/73.2(2)	749(1)/69.5(2)/76.0(1)/70.0(2)/80.1(1)/72.0(2)	85.1/86.7/90.1	80.0/82.5/87.6	84.3/86.4/90.5	82.5/84.2/87.7	79.6/81.8/86.1	83.2/84.8/88.1	79.6/81.8/86.1			
	Enthalpy exchange efficiency - 50Hz	Cooling	Ultra high/High/Low	%	60.3(1)/61.9(1)/67.3(1)	60.3(1)/61.2(1)/64.5(1)	65.2/67.9/74.6	59.2/61.8/69.5	59.2/63.8/73.1	67.7/70.7/76.8	62.6/66.4/74.0	68.9/71.8/77.5	62.6/66.4/74.0			
Heating		Ultra high/High/Low	%	66.6(1)/67.9(1)/72.4(1)	66.6(1)/67.4(1)/70.7(1)	75.5/77.6/82.0	69.0/72.2/78.7	73.1/76.3/82.7	72.8/75.3/80.2	68.6/71.7/77.9	73.8/76.1/80.8	68.6/71.7/77.9				
Operation mode				Heat exchange mode, bypass mode, fresh-up mode												
Heat exchange system				Air to air cross flow total heat (sensible + latent heat) exchange												
Heat exchange element				Specially processed non-flammable paper												
Dimensions	Unit	HeightxWidthxDepth		mm	285x776x525		301x1,113x886		368x1,354x920		368x1,354x1,172		731x1,354x1,172			
Weight	Unit			kg	24.0		46.5		61.5		79.0		157			
Casing				Galvanised steel plate												
Fan	Air flow rate - 50Hz	Heat exchange mode	Ultra high/High/Low	m ³ /h	150/140/105	250/230/155	350(1)/300(1)/200(1)	500(1)/425(1)/275(1)	650(1)/550(1)/350(1)	800(1)/680(1)/440(1)	1,000(1)/850(1)/550(1)	1,500(1)/1,275(1)/825(1)	2,000(1)/1,700(1)/1,100(1)			
		Bypass mode	Ultra high/High/Low	m ³ /h	150/140/105	250/230/155	350(1)/300(1)/200(1)	500(1)/425(1)/275(1)	650(1)/550(1)/350(1)	800(1)/680(1)/440(1)	1,000(1)/850(1)/550(1)	1,500(1)/1,275(1)/825(1)	2,000(1)/1,700(1)/1,100(1)			
External static pressure - 50Hz		Ultra high/High/Low		Pa	90/87/40	70/63/25	90(1)/70.0/50.0(1)									
Air filter				Multidirectional fibrous fleeces												
Sound pressure level - 50Hz	Type	Ultra high/High/Low		dB(A)	27.0/26.0/20.5	28.0/26.0/21.0	34.5(1)/32.0(1)/29.0(1)	37.5(1)/35.0(1)/30.5(1)	39.0(1)/36.0(1)/31.0(1)	39.0(1)/36.0(1)/30.5(1)	42.0(1)/38.5(1)/32.5(1)	42.0(1)/39.0(1)/33.5(1)	45.0(1)/41.5(1)/36.0(1)			
		Bypass mode		Ultra high/High/Low	dB(A)	27.0/26.5/20.5	28.0/27.0/21.0	34.5(1)/32.0(1)/28.0(1)	38.0(1)/35.0(1)/29.5(1)	38.0(1)/34.5(1)/30.5(1)	40.0(1)/36.5(1)/30.5(1)	42.5(1)/40.0(1)/32.5(1)	42.0(1)/39.0(1)/32.5(1)	45.0(1)/41.0(1)/35.0(1)		
Operation range				Around unit	°CDB		0°C~40°CDB, 80% RH or less									
Connection duct diameter				mm	100	150	200		250		2x250					
Power supply				Phase/Frequency/Voltage	Hz/V								1~ ; 50/60 ; 220-240/220			
Current				Maximum fuse amps (MFA)	A				15.0				16.0			
Specific energy consumption (SEC)	Cold climate		kWh/(m ² ·a)	-56.0(5)	-60.5(5)		-									
	Average climate		kWh/(m ² ·a)	-22.1(5)	-27.0(5)		-									
	Warm climate		kWh/(m ² ·a)	-0.100(5)	-5.30(5)		-									
SEC class				D / See note 5 B / See note 5												
Maximum flow rate at 100 Pa ESP	Flow rate		m ³ /h	130	207		-									
	Electric power input		W	129	160		-									
Sound power level (Lwa)				dB	40	43	51	54	58	61	62	65				
Annual electricity consumption				kWh/a	18.9(5)	13.6(5)		-								
Annual heating saved	Cold climate		kWh/a	41.0(5)	40.6(5)		-									
	Average climate		kWh/a	80.2(5)	79.4(5)		-									
	Warm climate		kWh/a	18.5(5)	18.4(5)		-									

(1) Measured according to JIS B 8628 | (2) Measured at reference flow rate according to EN13141-7 | (5) At reference flow rate in accordance with commission regulation (EU) No 1254/2014

Energy recovery ventilation, humidification and air processing

Post heating or cooling of fresh air for lower load on the air conditioning system

- › Energy saving ventilation using indoor heating, cooling and moisture recovery
- › Creates a high quality indoor environment by pre conditioning of incoming fresh air
- › Humidification of the fresh air results in comfortable indoor humidity level, even during heating
- › Free cooling possible when outdoor temperature is below indoor temperature (eg. during nighttime)
- › Low energy consumption thanks to DC fan motor
- › Prevent energy losses from over-ventilation while improving indoor air quality with optional CO₂ sensor
- › Shorter installation time thanks to easy adjustment of nominal air flow rate, so less need for dampers compared with traditional installation
- › Specially developed heat exchange element with High Efficiency Paper (HEP)
- › Can operate in over- and under pressure



VKM80-100GB(M)

Ventilation		VKM-GB/VKM-GBM		50GB	80GB	100GB	50GBM	80GBM	100GBM	
Power input - 50Hz	Heat exchange mode	Nom.	Ultra high/High/Low	kW	0.270/0.230/0.170	0.330/0.280/0.192	0.410/0.365/0.230	0.270/0.230/0.170	0.330/0.280/0.192	0.410/0.365/0.230
	Bypass mode	Nom.	Ultra high/High/Low	kW	0.270/0.230/0.140	0.330/0.280/0.192	0.410/0.365/0.230	0.270/0.230/0.170	0.330/0.280/0.192	0.410/0.365/0.230
Fresh air conditioning load	Cooling			kW	4.71 / 1.91 / 3.5	7.46 / 2.96 / 5.6	9.12 / 3.52 / 7.0	4.71 / 1.91 / 3.5	7.46 / 2.96 / 5.6	9.12 / 3.52 / 7.0
	Heating			kW	5.58 / 2.38 / 3.5	8.79 / 3.79 / 5.6	10.69 / 4.39 / 7.0	5.58 / 2.38 / 3.5	8.79 / 3.79 / 5.6	10.69 / 4.39 / 7.0
Temperature	Ultra high/High/Low			%	76/76/77.5	78/78/79	74/74/76.5	76/76/77.5	78/78/79	74/74/76.5
- 50Hz	Enthalpy exchange	Cooling	Ultra high/High/Low	%	64/64/67	66/66/68	62/62/66	64/64/67	66/66/68	62/62/66
	Heating	Ultra high/High/Low	%	67/67/69	71/71/73	65/65/69	67/67/69	71/71/73	65/65/69	
Operation mode				Heat exchange mode / Bypass mode / Fresh-up mode						
Heat exchange system				Air to air cross flow total heat (sensible + latent heat) exchange						
Heat exchange element				Specially processed non-flammable paper						
Humidifier				Natural evaporating type						
Dimensions	System	Unit	HeightxWidthxDepth	mm	387x1,764x832	387x1,764x1,214	387x1,764x832	387x1,764x1,214		
Weight	Unit			kg	94	110	112	100	119	123
Casing				Galvanised steel plate						
Fan-Air flow rate	Heat exchange mode	Ultra high/High/Low	m ³ /h	500/500/440	750/750/640	950/950/820	500/500/440	750/750/640	950/950/820	
	Bypass mode	Ultra high/High/Low	m ³ /h	500/500/440	750/750/640	950/950/820	500/500/440	750/750/640	950/950/820	
- 50Hz	Fan-External static pressure			Pa	210/170/140	210/160/110	150/100/70	200/150/120	205/155/105	110/70/60
Air filter				Multidirectional fibrous fleeces						
Sound pressure level - 50Hz	Heat exchange mode	Ultra high/High/Low	dBA	39/37/35	41.5/39/37	41/39/36.5	38/36/34	40/37.5/35.5	40/38/35.5	
	Bypass mode	Ultra high/High/Low	dBA	40/38/35.5	41.5/39/37	41/39/36.5	39/36/34.5	41/38/36	41/39/35.5	
Operation range	Around unit		°CDB	0°C~40°CDB, 80% RH or less						
	Supply air		°CDB	-15°C~40°CDB, 80% RH or less						
	Return air		°CDB	0°C~40°CDB, 80% RH or less						
	On coil temperature	Cooling/Max./Heating/Min.	°CDB	-15/43				-15/43		
Refrigerant				Electronic expansion valve						
Control				R-410A						
Type				2,0875						
GWP										
Connection duct diameter			mm	200	250		200		250	
Piping connections	Liquid	OD	mm	6.35						
	Gas	OD	mm	12.7						
	Water supply		mm	6.4						
	Drain		mm	-						
Power supply	Phase/Frequency/Voltage			Hz/V	PT3/4 external thread					
Current	Maximum fuse amps (MFA)			A	1~/50/220-240					
					15					

A man in a dark suit and tie is walking away from the camera down a long, modern office hallway. The hallway has a grey carpet, white walls, and a white ceiling with recessed lighting. Large windows are on the left side, and glass-walled offices are on the right. The scene is brightly lit, suggesting a professional and clean environment.

For small to large commercial spaces Daikin offers a range of inverter condensing units for use in conjunction with air handling units. In situations where Daikin commercial range ventilation units cannot satisfy the ventilation requirement due to building constraints (large atriums, banquet halls etc), air handling units represent the ideal solution. Air handling units provide large fresh air volumes (up to 140,000 m³/h) and high ESPs enabling the use of extensive ductwork runs.

An air handler or air handling unit provides a tailor-made solution for optimising air conditions throughout multiple spaces. An air handling unit can be customised to your building - with no installation restrictions or design limitations - as Daikin air handling units are based on a completely unique modular design, so they can be sized (in increments of 1 cm) to your exact requirements.

Daikin's air handling units solutions

You will find your match

Why choose Daikin air handling units with a DX connection?



Simplifying business

The unique total solution approach by Daikin helps businesses to propose better cross-pillar solutions, to increase their success ratio by providing unmatched product combinations to the end-user and to simplify the life of installers by supplying high-quality products coming from the same manufacturer. Contrary to other manufacturers, Daikin does not use OEM products in its AHU with DX offer. Many competitors are either offering OEM DX outdoor units or OEM AHU which create additional problems when warranties or faults arise. **Having a single interface for your business makes Daikin the right choice.**

One-stop shop

Daikin is the only global manufacturer in the market **capable of offering a true Plug & Play solution** where Daikin AHUs manufactured by Daikin Applied Europe and certified by Eurovent, offer off-the-shelf compatibility with Daikin's unique VRV outdoor unit range for the best performance in the market. This unique integration of cross-pillar products under the same umbrella, gives the customer both peace-of-mind and added value when promoting a total solution approach.

Complete range of possibilities

Thanks to the **most complete offer in the market**, Daikin has the solution for all types of commercial applications requiring fresh air. Daikin provides ventilation solutions based on AHU from 2,500 m³/h up to 140,000 m³/h either with natural heat recovery or more advanced ventilation solutions where a VRV outdoor unit can be connected to the Daikin AHU for ultimate climate control. The harmonized control, between the VRV outdoor unit and the AHU, offer outstanding reliable operation of the system when connected to an iTM.

Advantages

- › Unique manufacturer offering a complete range
- › Plug & Play solution
- › Direct iTM compatibility

Daikin's fresh air solution



Highly efficient EC fan



Factory fitted and tested DX heat exchanger



Efficient filtration

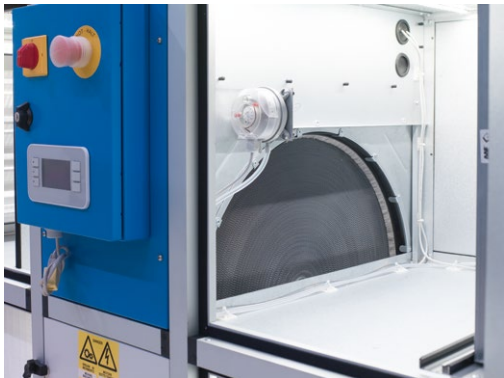

Heat wheel for energy recovery

Why use VRV and ERQ condensing units for connection to air handling units?

High Efficiency

Daikin heat pumps are renowned for their high energy efficiency. Integrating the AHU with a heat recovery system is even more effective since an office system can frequently be in cooling mode

while the outdoor air is too cold to be brought inside in an unconditioned state. In this case heat from the offices is merely transferred to heat up the cold fresh air.

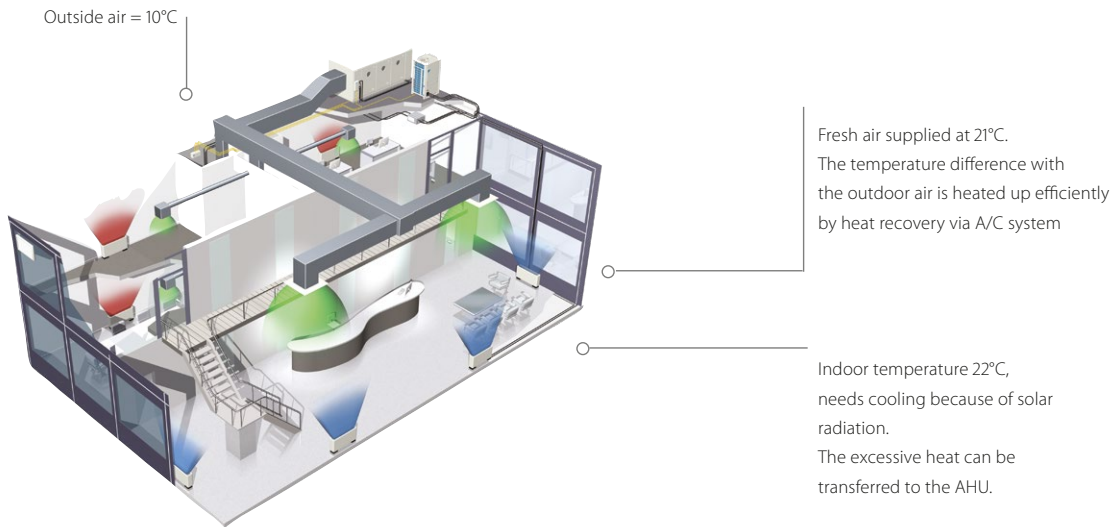

Fast response to changing loads resulting in high comfort levels

Daikin ERQ and VRV units respond rapidly to fluctuations in supply air temperature, resulting in a steady indoor temperature and resultant high comfort levels for the end user. The ultimate is the VRV range which improves comfort even more by offering continuous heating, also during defrost.

Easy Design and Installation

The system is easy to design and install since no additional water systems such as boilers, tanks and gas connections etc. are required. This also reduces both the total system investment and running cost.

Daikin Fresh air package

- > Plug & Play connection between VRV/ERQ and the entire D-AHU modular range.
- > Factory fitted and welded DX coil control and expansion valve kits.

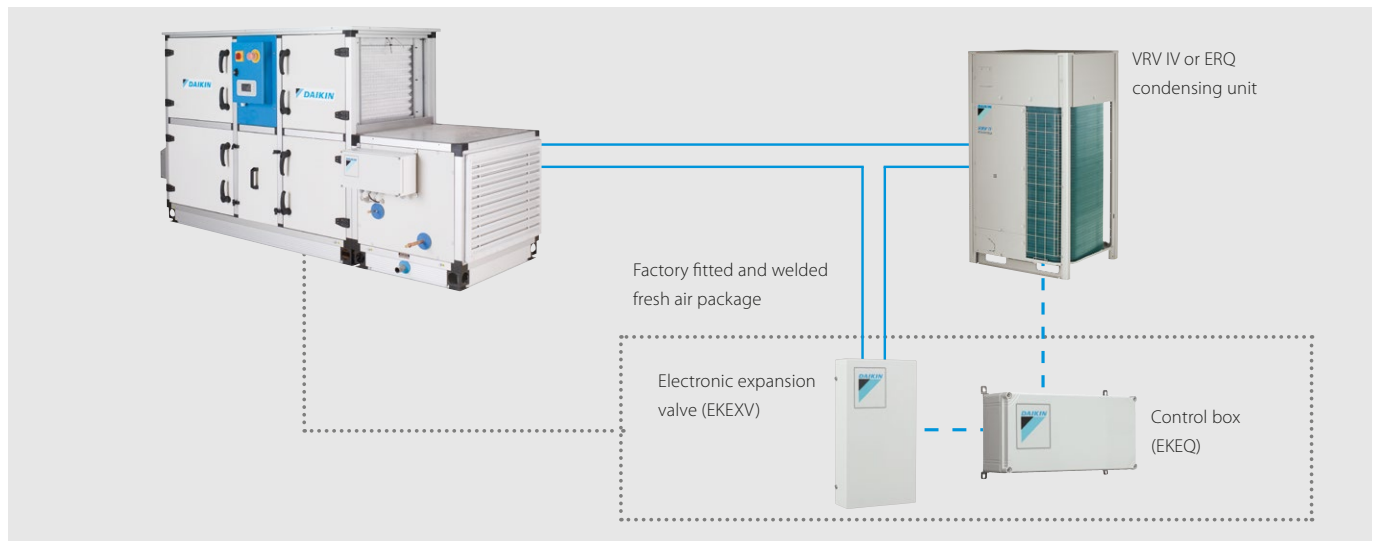

In order to maximise installation flexibility, 4 types of control systems are offered

W control: Off the shelf control of air temperature (discharge temperature, suction temperature, room temperature) via any DDC controller, easy to setup

X control: Precise control of air temperature (discharge temperature, suction temperature, room temperature) requiring a preprogrammed DDC controller (for special applications)

Z control: Control of air temperature (suction temperature, room temperature) via Daikin control (no DDC controller needed)

Y control: Control of refrigerant (T_e/T_c) temperature via Daikin control (no DDC controller needed)

1. W control ($T_s/T_r/T_{ROOM}$ control):

Air temperature control via DDC controller

Room temperature is controlled as a function of the air handling unit suction or discharge air (customer selection). The DDC controller is translating the temperature difference between set point and air suction temperature (or air discharge temperature or room temperature) into a proportional 0-10V signal which is transferred to the Daikin control box (EKEQFCBA). This voltage modulates the capacity requirements of the outdoor unit.

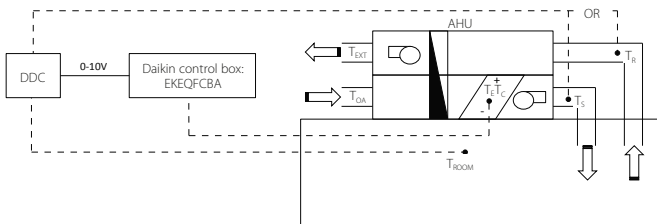

2. X control ($T_s/T_r/T_{ROOM}$ control):

Precise air temperature control via DDC controller

Room temperature is controlled as a function of the air handling unit suction or discharge air (customer selection). The DDC controller is translating the temperature difference between set point and air suction temperature (or air discharge temperature or room temperature) into a reference voltage (0-10V) which is transferred to the Daikin control box (EKEQFCBA). This reference voltage will be used as the main input value for the compressor frequency control.

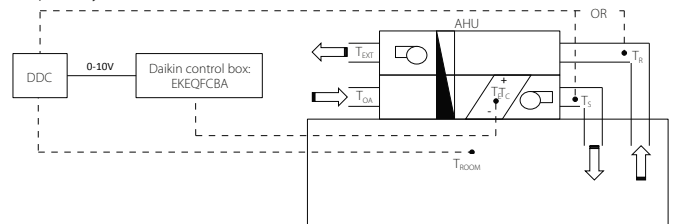

3. Y control (T_e/T_c control):

By fixed evaporating /condensing temperature

A fixed target evaporating or condensing temperature can be set by the customer. In this case, room temperature is only indirectly controlled. A Daikin wired remote control (BRC1* - optional) have to be connected for initial set-up but not required for operation.

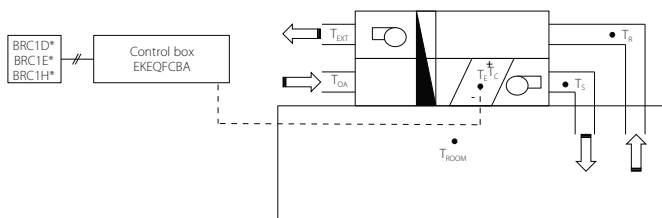

4. Z control (T_s/T_{ROOM} control):

Control your AHU just like a VRV indoor unit with up to 100% fresh air

Allows the possibility to control the AHU just like a VRV indoor unit. Meaning temperature control will be focused on return air temperature from the room into the AHU. Requires BRC1* for operation. The only control that allows the combination of other indoor units to the AHU at the same time.

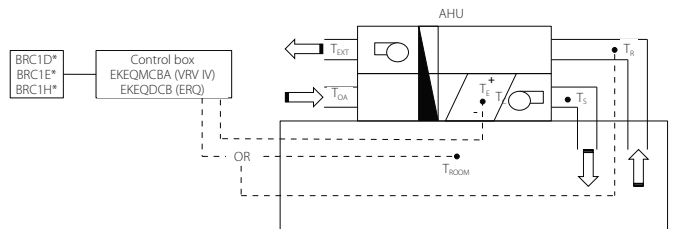

T_s = Supply air temperature	T_r = Return air temperature	T_{OA} = Outdoor air temperature	T_{ROOM} = Room air temperature
T_{EXT} = Extraction air temperature	T_e = Evaporating temperature	T_c = Condensing temperature	

	Option kit	Features
Possibility W	EKEQFCBA	Off-the-shelf DDC controller that requires no pre-configuration
Possibility X		Pre-configured DDC controller required
Possibility Y		Using fixed evaporating temperature, no set point can be set using remote control
Possibility Z	EKEQDCB EKFQMCBA*	Using Daikin infrared remote control BRC1* Temperature control using air suction temperature or room temperature (via remote sensor)

* EKEQMCB (for 'multi' application)

VRV - for larger capacities (from 8 to 54HP)

An advanced solution for both pair and multi application

- › Inverter controlled units
- › Heat recovery, heat pump
- › R-410A
- › Control of room temperature via Daikin control
- › Large range of expansion valve kits available
- › BRC1H* is used to set the set point temperature (connected to the EKEQMCBA).
- › Connectable to all VRV heat recovery and heat pump systems

W, X, Y control for VRV IV heat pump

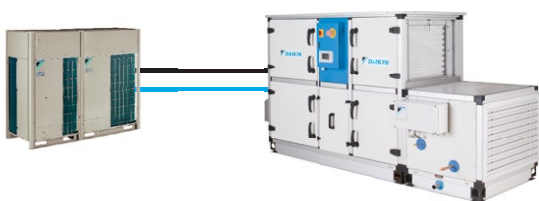

Z control for all VRV outdoor units

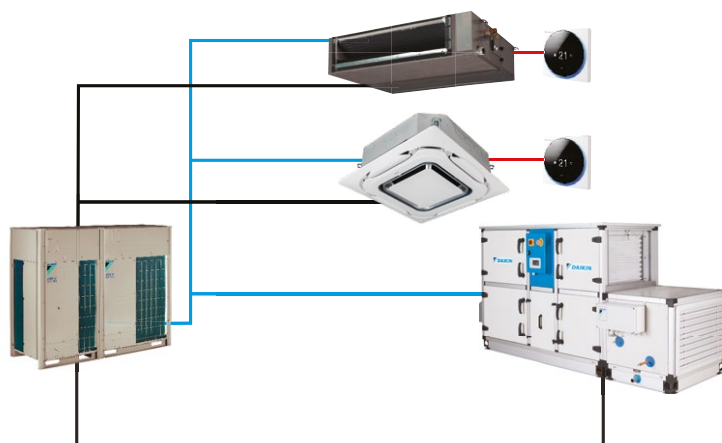

- Refrigerant piping
- F1-F2
- P1-P2



ERQ - for smaller capacities (from 100 to 250 class)

A basic fresh air solution for pair application

- › Inverter controlled units
- › Heat pump
- › R-410A
- › Wide range of expansion valve kits available
- › Perfect for the Daikin Modular air handling unit

The "Daikin Fresh Air Package" provides a complete Plug & Play Solution including AHU, ERQ or VRV Condensing Unit and all unit control (EKEQ, EKEX, DDC controller) factory mounted and configured. The easiest solution with only one point of contact.



ERQ-AW1

Ventilation				ERQ	100AV1	125AV1	140AV1
Capacity range			HP		4	5	6
Cooling capacity	Nom.		kW		11.2	14.0	15.5
Heating capacity	Nom.		kW		12.5	16.0	18.0
Power input	Cooling	Nom.	kW		2.81	3.51	4.53
	Heating	Nom.	kW		2.74	3.86	4.57
EER					3.99		3.42
COP					4.56	4.15	3.94
Dimensions	Unit	HeightxWidthxDepth	mm		1,345x900x320		
Weight	Unit		kg		120		
Casing	Material				Painted galvanized steel plate		
Fan-Air flow rate	Cooling	Nom.	m ³ /min		106		
	Heating	Nom.	m ³ /min		102	105	
Sound power level	Cooling	Nom.	dBA		66	67	69
Sound pressure level	Cooling	Nom.	dBA		50	51	53
	Heating	Nom.	dBA		52	53	55
Operation range	Cooling	Min./Max.	°CDB		-5/46		
	Heating	Min./Max.	°CWB		-20/15.5		
	On coil temperature	Heating/Min./Cooling/Max.	°CDB		10/35		
Refrigerant	Type				R-410A		
	Charge		kg		4.0		
			TCO ₂ eq		8.4		
	GWP				2,087.5		
	Control				Expansion valve (electronic type)		
Piping connections	Liquid	OD	mm		9.52		
	Gas	OD	mm		15.9		19.1
	Drain	OD	mm		26x3		
Power supply	Phase/Frequency/Voltage		Hz/V		1N~/50/220-240		
Current	Maximum fuse amps (MFA)		A		32.0		

Ventilation				ERQ	125AW1	200AW1	250AW1
Capacity range			HP		5	8	10
Cooling capacity	Nom.		kW		14.0	22.4	28.0
Heating capacity	Nom.		kW		16.0	25.0	31.5
Power input	Cooling	Nom.	kW		3.52	5.22	7.42
	Heating	Nom.	kW		4.00	5.56	7.70
EER					3.98	4.29	3.77
COP					4.00	4.50	4.09
Dimensions	Unit	HeightxWidthxDepth	mm		1,680x635x765	1,680x930x765	
Weight	Unit		kg		159	187	240
Casing	Material				Painted galvanized steel plate		
Fan-Air flow rate	Cooling	Nom.	m ³ /min		95	171	185
	Heating	Nom.	m ³ /min		95	171	185
Sound power level	Nom.		dBA		72	78	
Sound pressure level	Nom.		dBA		54		58
Operation range	Cooling	Min./Max.	°CDB		-5/43		
	Heating	Min./Max.	°CWB		-20/15		
	On coil temperature	Heating/Min./Cooling/Max.	°CDB		10/35		
Refrigerant	Type				R-410A		
	Charge		kg		6.2	7.7	8.4
			TCO ₂ eq		12.9	16.1	17.5
	GWP				2,087.5		
	Control				Electronic expansion valve		
Piping connections	Liquid	OD	mm		9.52		
	Gas	OD	mm		15.9	19.1	22.2
Power supply	Phase/Frequency/Voltage		Hz/V		3N~/50/400		
Current	Maximum fuse amps (MFA)		A		16	25	

Integration of ERQ and VRV in third party air handling units

a wide range of expansion valve kits and control boxes

Combination table

		Control box			Expansion valve kit										Mixed connection with VRV indoor units
		EKEQDCB Z control	EKEQFCBA W,X,Y control	EKEQMCBA Z control	EKE XV50	EKE XV63	EKE XV80	EKE XV100	EKE XV125	EKE XV140	EKE XV200	EKE XV250	EKE XV400	EKE XV500	
1-phase	ERQ100	P	P	-	-	P	P	P	P	-	-	-	-	-	Not possible
	ERQ125	P	P	-	-	P	P	P	P	-	-	-	-		
	ERQ140	P	P	-	-	-	P	P	P	-	-	-	-		
3-phase	ERQ125	P	P	-	-	P	P	P	P	-	-	-	-	Not possible	
	ERQ200	P	P	-	-	-	-	P	P	P	P	-	-		
	ERQ250	P	P	-	-	-	-	-	P	P	P	-	-		
	VRV III	-	-	n1	n1	n1	n1	n1	n1	n1	n1	n1	n1	Mandatory	
	VRV IV H/P / VRV IV W-series VRV IV S-series	-	P (1->3)	n2	n2	n2	n2	n2	n2	n2	n2	n2	n2	Possible (not mandatory)	
	VRV IV H/R VRV IV i-series	-	n1	-	n1	n1	n1	n1	n1	n1	n1	n1	n1	Mandatory	

- P (pair application): combination depends on the capacity of the air handling unit
- n1 (multi application) - Combination of AHUs and VRV DX indoors (mandatory). To determine the exact quantity please refer to the engineering data book.
- n2 (multi application) - Combination of AHUs and VRV DX indoors (not mandatory). To determine the exact quantity please refer to the engineering data book.
- Control box EKEQFA can be connected to some types of VRV IV outdoor units (with a maximum of 3 boxes per unit). Do not combine EKEQFA control boxes with VRV DX indoor units, RA indoor units or hydroboxes

Capacity table

Cooling

EKE XV Class	Allowed heat exchanger capacity (kW)			Allowed heat exchanger volume (dm ³)	
	Minimum	Standard	Maximum	Minimum	Maximum
50	5.0	5.6	6.2	1.33	1.65
63	6.3	7.1	7.8	1.66	2.08
80	7.9	9.0	9.9	2.09	2.64
100	10.0	11.2	12.3	2.65	3.30
125	12.4	14.0	15.4	3.31	4.12
140	15.5	16.0	17.6	4.13	4.62
200	17.7	22.4	24.6	4.63	6.60
250	24.7	28.0	30.8	6.61	8.25
400	35.4	45.0	49.5	9.26	13.2
500	49.6	56.0	61.6	13.2	16.5

Saturated evaporating temperature: 6°C
Air temperature: 27°C DB / 19°C WB

Heating

EKE XV Class	Allowed heat exchanger capacity (kW)			Allowed heat exchanger volume (dm ³)	
	Minimum	Standard	Maximum	Minimum	Maximum
50	5.6	6.3	7.0	1.33	1.65
63	7.1	8.0	8.8	1.66	2.08
80	8.9	10.0	11.1	2.09	2.64
100	11.2	12.5	13.8	2.65	3.30
125	13.9	16.0	17.3	3.31	4.12
140	17.4	18.0	19.8	4.13	4.62
200	19.9	25.0	27.7	4.63	6.60
250	27.8	31.5	34.7	6.61	8.25
400	39.8	50.0	55.0	9.26	13.2
500	55.1	63.0	69.3	13.2	16.5

Saturated condensing temperature: 46°C
Air temperature: 20°C DB

EKE XV - Expansion valve kit for air handling applications

Ventilation		EKE XV	50	63	80	100	125	140	200	250	400	500
Dimensions	Unit	mm	401x215x78									
Weight	Unit	kg	2.9									
Sound pressure level Nom.		dB(A)	45									
Operation range	On coil	Heating Min.	10 (1)									
	temperature	Cooling Max.	35 (2)									
Refrigerant	Type / GWP		R-410A / 2.087,5									
Piping connections	Liquid	OD	6.35				9.52				12.7	15.9

(1) The temperature of the air entering the coil in heating mode can be reduced to -5°CDB. Contact your local dealer for more information. (2) 45% Relative humidity.

EKE Q - Control box for air handling applications

Ventilation		EKE Q	FCBA	DCB	MCBA
Application			See note	Pair	Multi
Outdoor unit			ERQ / VRV	ERQ	VRV
Dimensions	Unit	mm		132x400x200	
Weight	Unit	kg	3.9		3.6
Power supply	Phase/Frequency/Voltage	Hz/V		1~/50/230	

The combination of EKEQFCBA and ERQ is in pair application. The EKEQFCBA can be connected to some type of VRV IV outdoor units with a maximum of 3 control boxes. The combination with DX indoor units, hydroboxes, RA outdoor units, ... is not allowed. Refer to the combination table drawing of the outdoor unit for details.

Pair application selection

- › **the outdoor unit is connected to ONE COIL (with single circuit or maximum 3 interlaced circuits) using up to 3 control boxes**
- › **indoor unit combination is not allowed**
- › **only works with X, W, Y control**

Step 1: Required AHU capacity

An AHU with double flow, heat recovery and 100% fresh air is to be installed in Europe where the outdoor sizing temperature is 35 °CDB and the target supply air temperature for fresh air is 25 °CDB. Load calculations point to a required capacity of 45kW. By checking on the EKEXV capacity table, for cooling operation, 40kW falls within the 400 class valve. Since 40kW is not the nominal capacity, a class adjustment has to be done. $40/45=0,89$ and $0,89 \times 400=356$. So the capacity class of the expansion valve kit is 356.

Step 2: Outdoor unit selection

For this AHU, a VRV IV heat pump model with continuous heating is going to be used (RYYQ-T series). For a capacity of 40kW at 35 °CDB, an outdoor of 14HP (RYYQ14T) is selected. The capacity class of the 14 HP outdoor unit is 350.

Total connection ratio of the system is $356/350=102\%$ hence it falls within the range 90-110%.

Step 3: Control box selection

In this particular case, the control will work with precise air temperature control. Only W or X control allow this. Since the consultant wants to use an "off-the-shelf" DDC module, the EKEQFCBA box with W control allows easy set-up due to pre-set factory values.

Multi application selection

- › **the outdoor unit can be connected to MULTIPLE COILS (and their control boxes)**
- › **indoor units are also connectable but not mandatory**
- › **only works with Z control**

Step 1: Required AHU capacity

An AHU with double flow, heat recovery and 100% fresh air is to be installed in Europe where the outdoor sizing temperature is 35 °CDB and the target supply air temperature for fresh air is 25 °CDB. On top of this, for this building, 5 round-flow cassette units FXFQ50A will also be connected to this OU. Load calculations point to a required capacity of 20kW for the AHU and 22,5 kW for the indoor units. By checking on the EKEXV capacity table, for cooling operation, 20kW falls within the 200 class valve. Since 22,4 kW is the nominal capacity, a class adjustment has to be done. $20/22,4=0,89$ and $0,89 \times 200=178$. So the capacity class of the expansion valve kit is 178. Total capacity class of the indoor unit system is $178+250=428$

Step 2: Outdoor unit selection

For this system where a AHU is connected with indoor units, it is mandatory to use a heat recovery unit. By consulting the engineering databook for REYQ-T, the total required capacity of 42,5 kW requires a 16HP model REYQ16T. Which will deliver 45kW at the design temperature of 35 °CDB. This unit has a capacity class of 400. Total connection ratio of the system is $428/400=107\%$ hence it falls within the range 50-110%.

Step 3: Control box selection

In this particular case, the only available control is Z control and the combination of AHU and VRV DX indoor units requires EKEQMCBA control box.

Pair application examples

Pair application layout #1: Example for W or X control with EKEQFCBA box

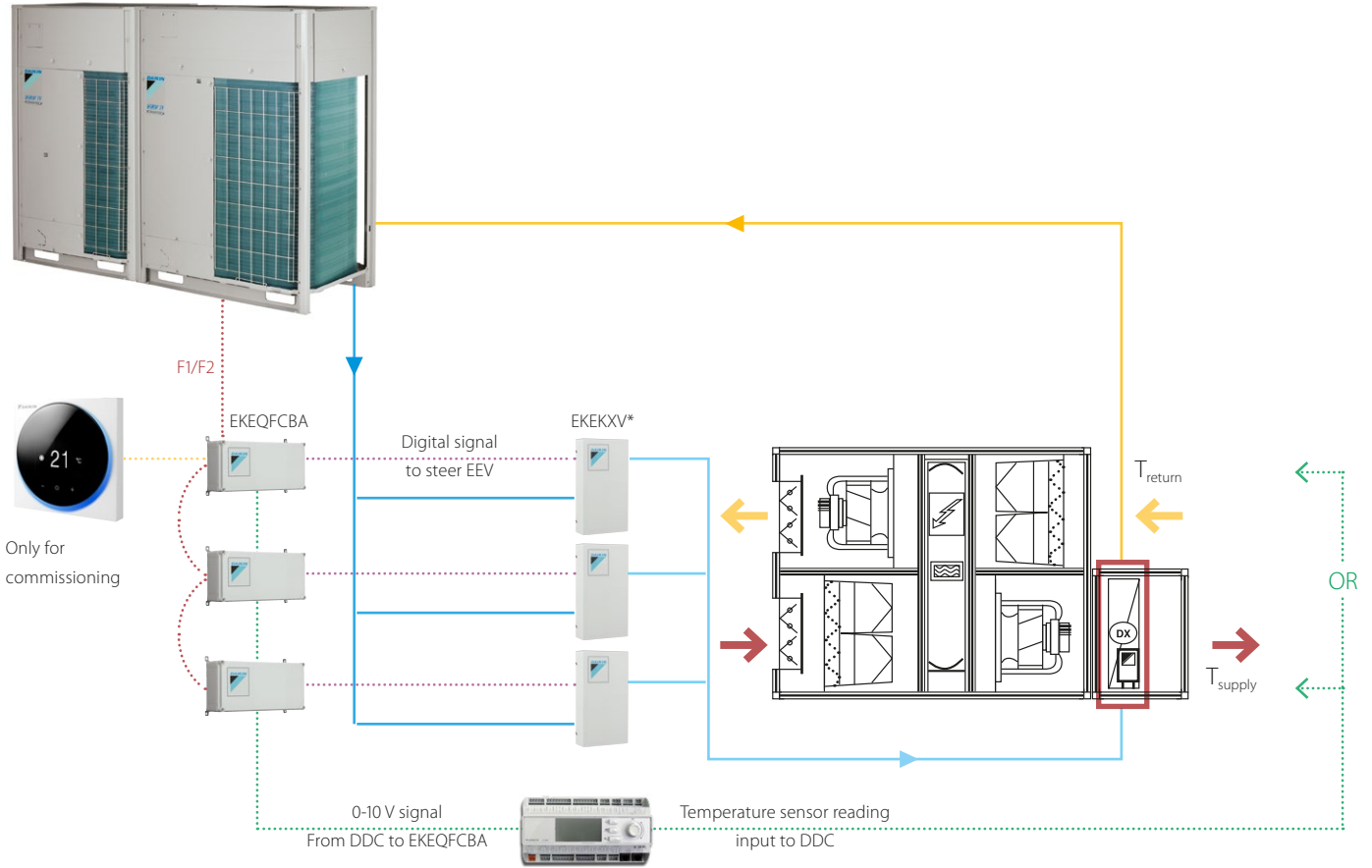

Outdoor unit compatibility

- RYYQ8T > RYYQ54T
- RXYQ8T > RXYQ54T
- RWEYQ8T9 > RWEYQ30T9
- ERQ100 > ERQ250¹

(1) Only available in 1 to 1 combination

Connection restrictions

Connection Ratio VRV: between 90-110%

Connection Ratio ERQ: between 50-110%

$$CR = \frac{\sum IU CC}{\sum OU CC} = \frac{\sum (CF \times EKEV CC)_{1-3}}{\sum OU CC}$$

CF is the correction factor

CC is the capacity class

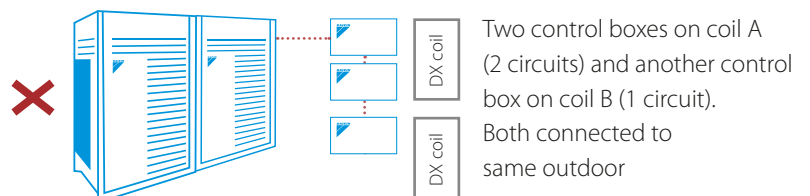
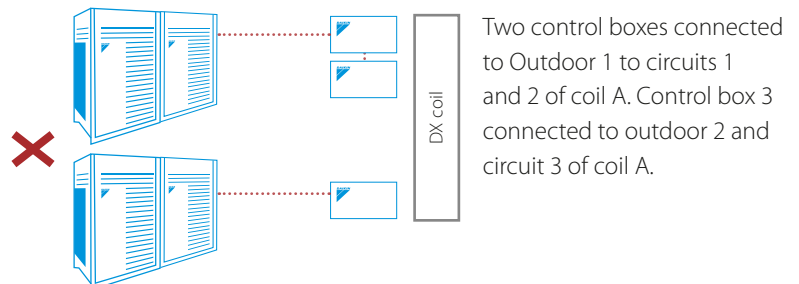
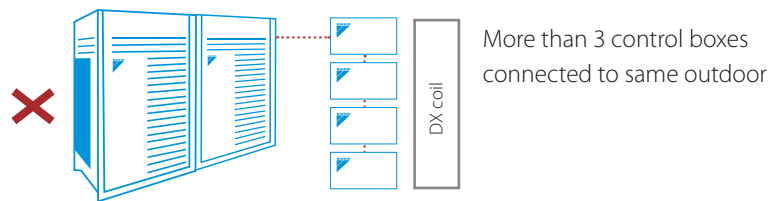

Pair application layout #2: Example for Y control with EKEQFCBA box

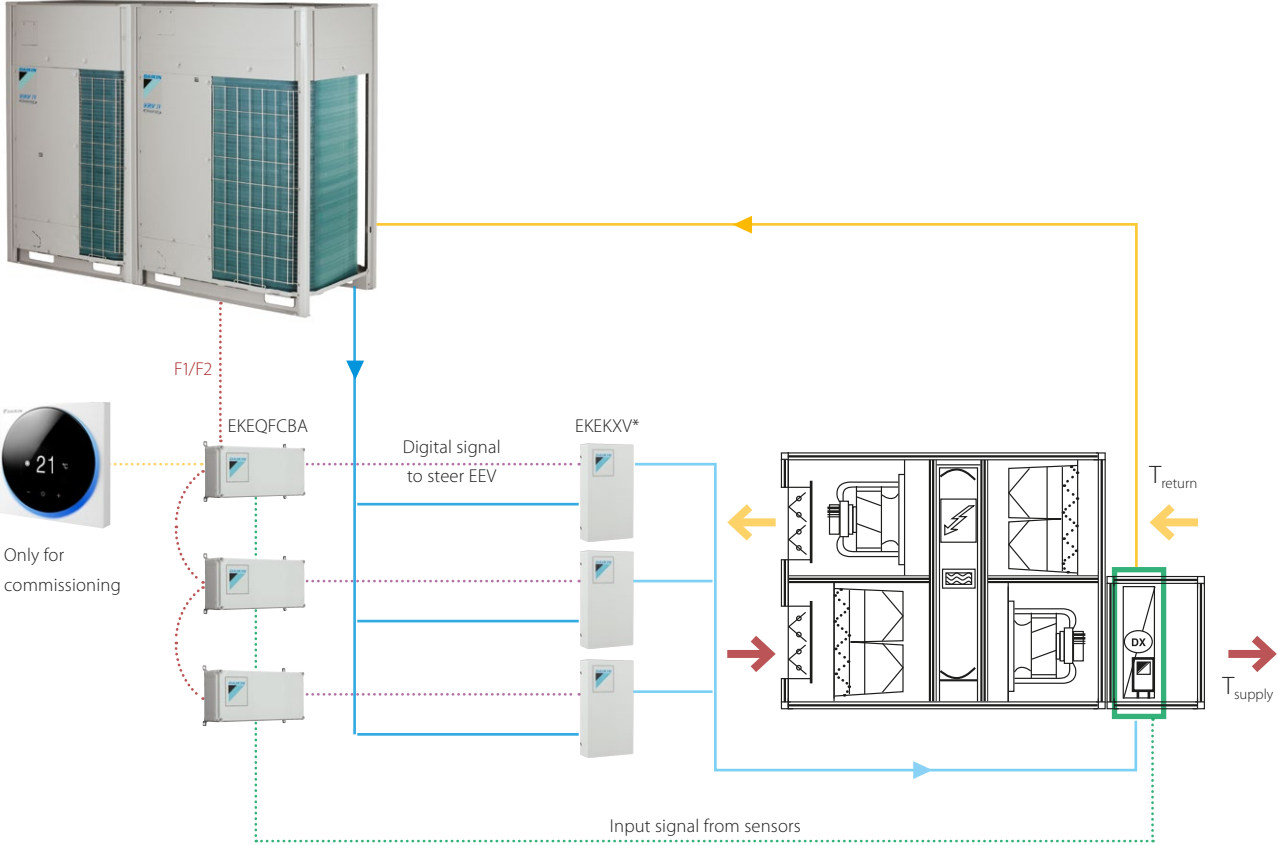

Outdoor unit compatibility

- RYYQ8T > RYYQ54T
- RXYQ8T > RXYQ54T
- RWEYQ8T9 > RWEYQ30T9
- ERQ100 > ERQ250¹

(1) Only available in 1 to 1 combination

Connection restrictions

Connection Ratio between 90-110%

Connection Ratio ERQ: between 50-110%

$$CR = \frac{\sum IU CC}{\sum OU CC} = \frac{\sum (CF \times EKEKXV CC)_{1-3}}{\sum OU CC}$$

CF is the correction factor
 CC is the capacity class

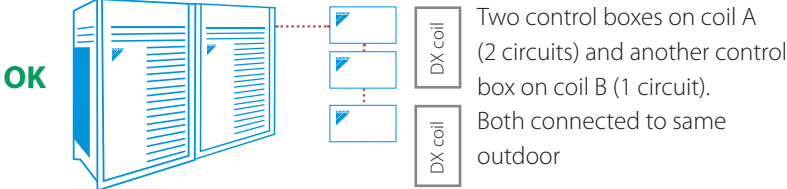
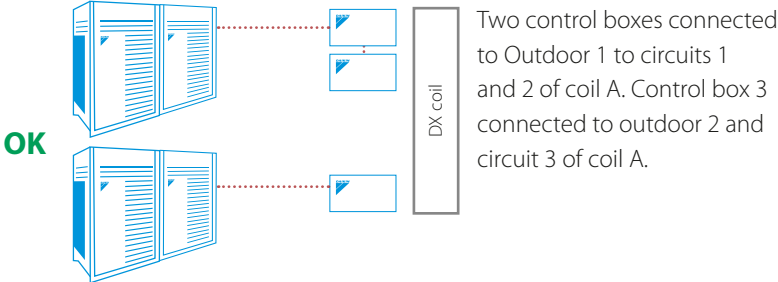
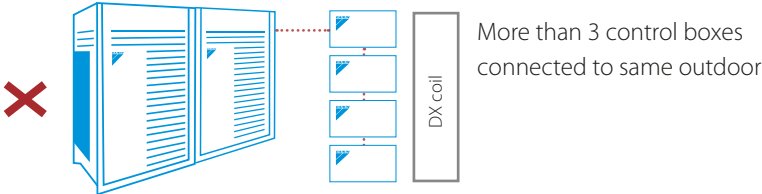

Multi application examples

Multi application layout #1: Example for Z control with EKEQMCBA box and no VRV indoor units

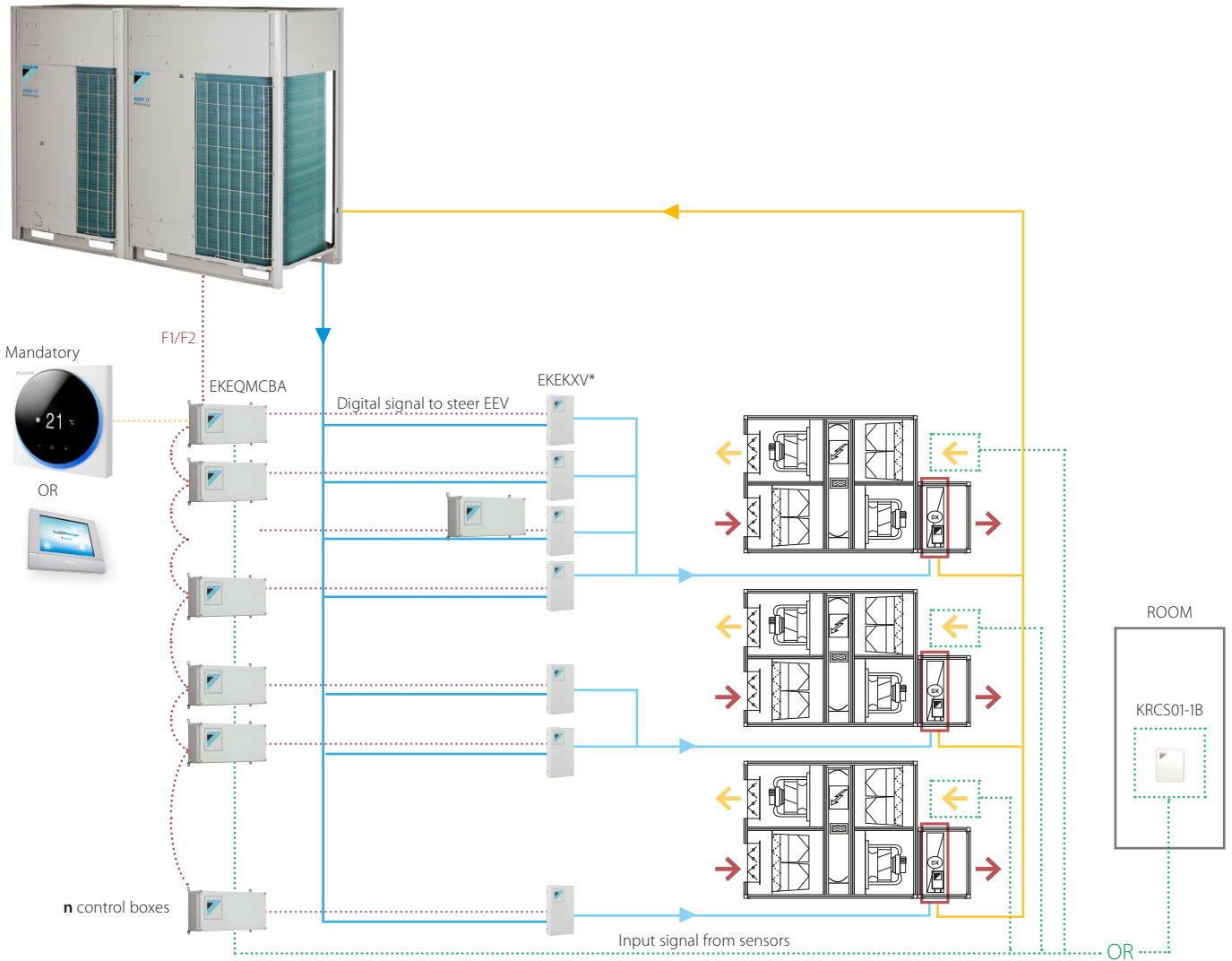

Outdoor unit compatibility

- RYYQ8T > RYYQ54T
- RXYQ8T > RXYQ54T
- RWEYQ8T9 > RWEYQ30T9

EKEQMCBA control box

ERQ100 > ERQ250¹

EKEQDCB control box

(1) Only available in 1 to 1 combination

Connection restrictions

Connection Ratio between 90-110%

Connection Ratio ERQ: between 50-110%

$$CR = \frac{\sum IU CC}{\sum OU CC} = \frac{\sum (CF \times EKEKXV CC)_{1-n}}{\sum OU CC}$$

CF is the correction factor

CC is the capacity class

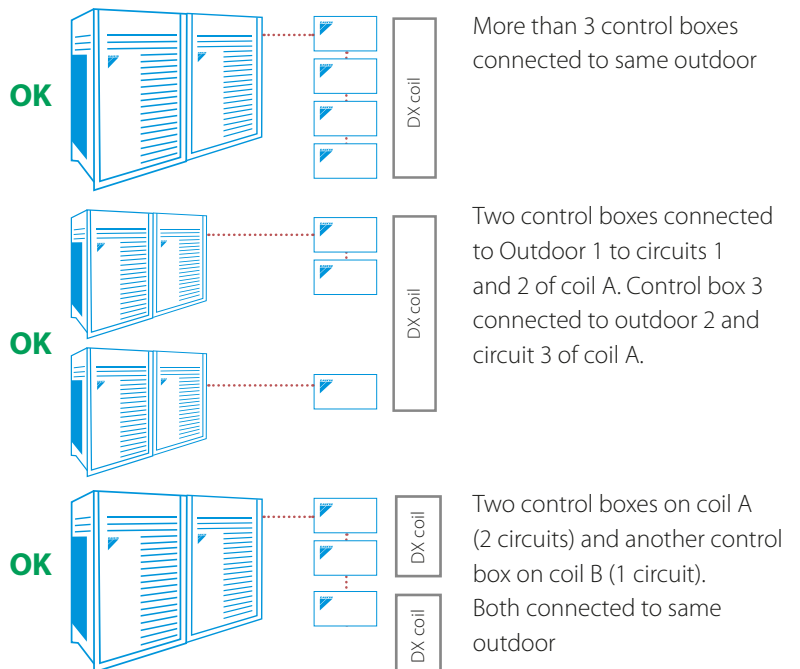

Multi application layout #2: Example for Z control with EKEQMCBA box and VRV indoor units

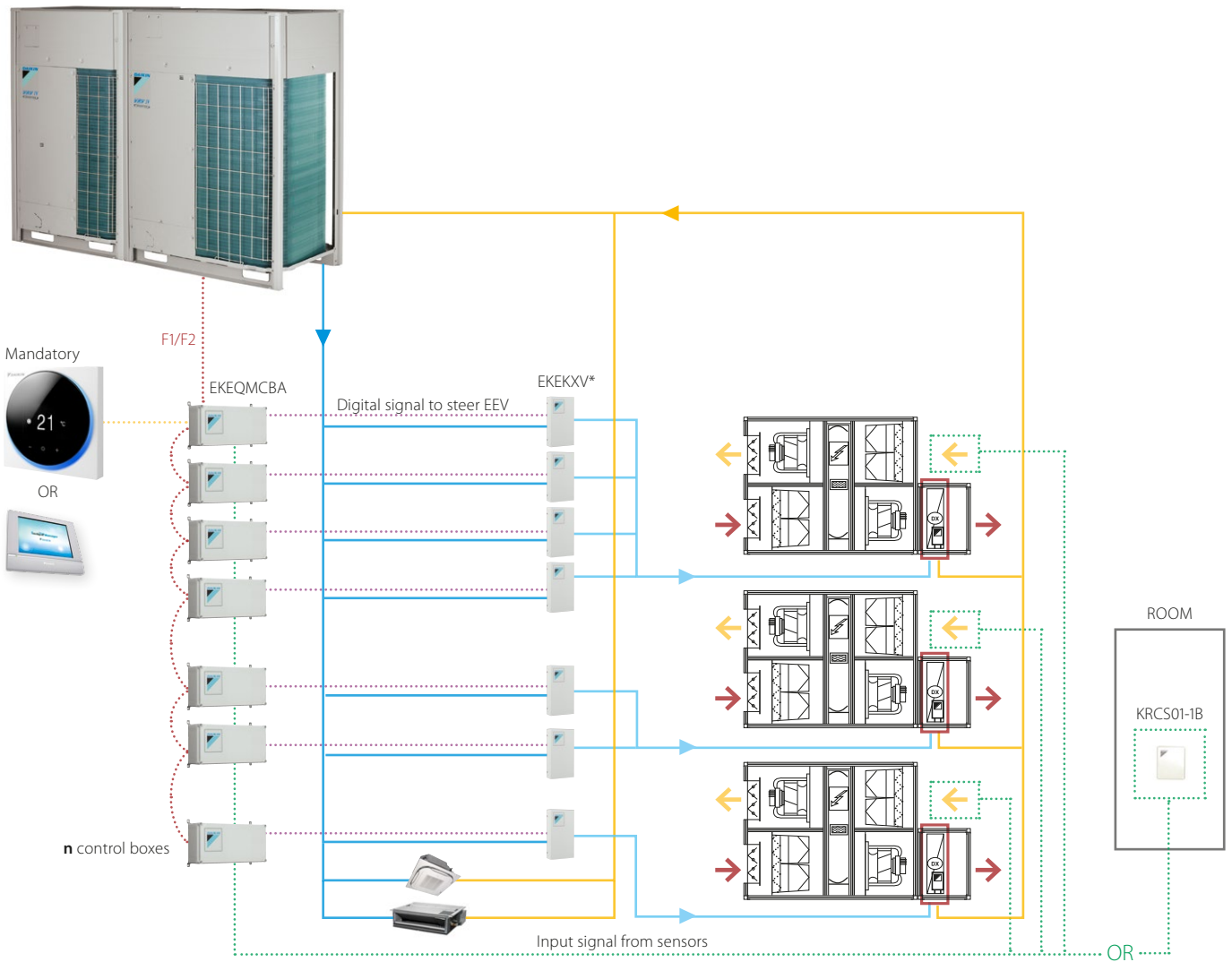

Outdoor unit compatibility

Not mandatory to have VRV DX indoors:

- RYYQ8T > RYYQ54T
- RXYQ8T > RXYQ54T
- RWEYQ8T9 > RWEYQ30T9

Mandatory to have VRV DX indoors:

- REYQ8T > REYQ54T

Connection restrictions

Connection Ratio between 50-110%

$$CR = \frac{\sum IU CC}{\sum OU CC} = \frac{\sum (CF \times EKEV CC)_{1-n}}{\sum OU CC}$$

RULES: $\sum EKEV CC$: 0-60% $\sum IU CC$: 50-110%

CF is the correction factor
CC is the capacity class

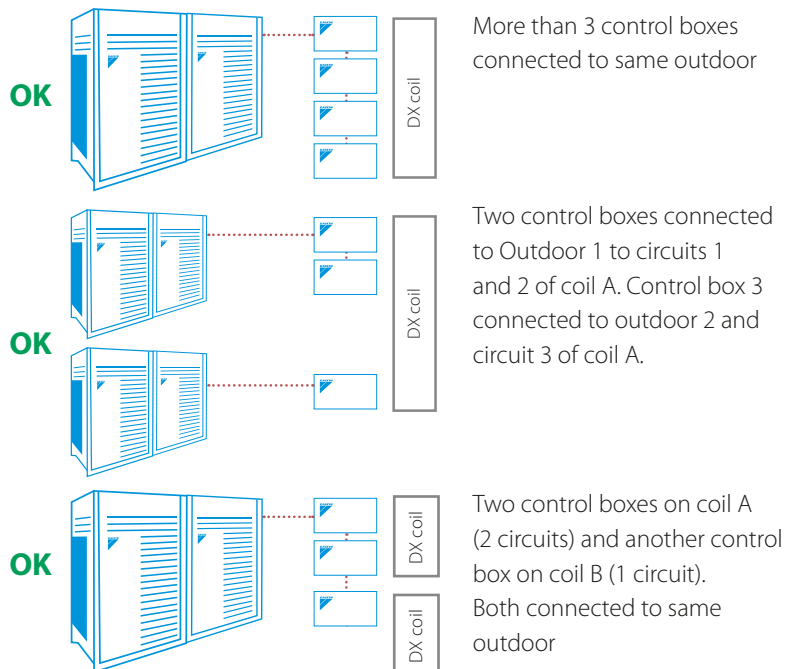

Options & accessories





Madoka

User-friendly wired remote controller with premium design



White



Silver



Black

BRC1H519W7/S7/K7

- > Sleek and elegant design
- > Intuitive touch button control
- > 3 color versions
- > Advanced settings and monitoring can be easily done via your smartphone
- > Flat back for easy wall installation
- > Compact to fit standard size socket boxes



reddot award 2018
winner



DESIGN
AWARD
2018

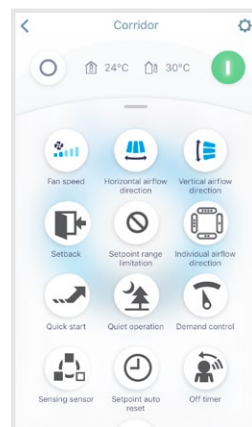

Advanced user settings

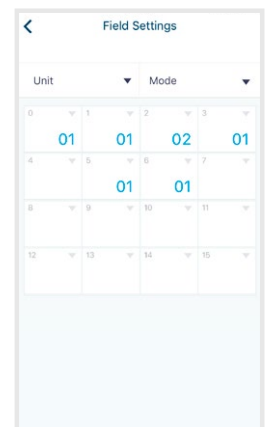

Field settings

DIRECT INTEGRATION
WITH DAIKIN VENTILATION PRODUCTS

		Heat Recovery Ventilation - Modular L (Smart)						
		ALB02LBS/RBS	ALB03LBS/RBS	ALB04,05LBS/RBS	ALB06,07LBS/RBS	VAM 150FC9	VAM 250FC9	VAM 350J
Individual control systems	BRC301B61 VAM wired remote control	•	•	•	•	•	•	•
	Madoka BRC1H519W7 (White) / BRC1H519S7 (Silver) / BRC1H519K7 (Black) User-friendly wired remote controller with premium design	•	•	•	•	•	•	•
	BRC1E53A/B/C Wired remote control with full-text interface and back-light	•	•	•	•	•	•	•
	BRC1D52 Standard wired remote control with weekly timer	•	•	•	•	•	•	•
Centralised control systems	DCC601A51 intelligent Tablet Controller	•	•	•	•	•	•	•
	DCS601C51 intelligent Touch Controller	•	•	•	•	•	•	•
	DCS302C51 Central remote control	•	•	•	•	•	•	•
	DCS301B51 Unified ON/OFF control	•	•	•	•	•	•	•
	DST301B51 Schedule timer	•	•	•	•	•	•	•
Building Management System & Standard protocol interface	DCM601A51 intelligent Touch Manager	•	•	•	•	•	•	•
	EKMBDXA Modbus interface	•	•	•	•	•	•	•
	DMS502A51 BACnet Interface	•	•	•	•	•	•	•
	DMS504B51 LonWorks Interface	•	•	•	•	•	•	•
Filters	Coarse 55% (G4)	ALF02G4A	ALF03G4A	ALF05G4A	ALF07G4A			
	ePM ₁₀ 75% (M5)	ALF02M5A	ALF03M5A	ALF05M5A	ALF07M5A			
	ePM ₁₀ 70% (M6)							EKAFVJ50F6
	ePM ₁ 50% (F7)	ALF02F7A	ALF03F7A	ALF05F7A	ALF07F7A			
	ePM ₁ 55% (F7)							EKAFVJ50F7
	ePM ₁ 70% (F8)							EKAFVJ50F8
	ePM ₁ 80% (F9)	ALF02F9A	ALF03F9A	ALF05F9A	ALF07F9A			
	High efficiency filter							
	Replacement air filter							
Mechanical accessories	Rail	ALA02RLA	ALA03RLA	ALA05RLA	ALA07RLA			
	Rectangular to round duct transition	ALA02RCA	ALA03RC	ALA05RCA	ALA07RCA			
	Separate plenum							
CO ₂ sensor	BRYMA200	BRYMA200	BRYMA200	BRYMA200			BRYMA65	
Electrical heater NEW	ALD02HEFB	ALD03HEFB	ALD05HEFB	ALD07HEFB	GSIEKA10009	GSIEKA15018	GSIEKA20024	
Silencer (900mm depth)	ALS0290A	ALS0390A	ALS0590A	ALS0790A				
Electrical accessories	Wiring adapter for external monitoring/control (controls 1 entire system)					KRP2A51	KRP2A51	KRP2A51 (2)
	Adapter PCB for humidifier					KRP50-2	KRP50-2	KRP1C4 (5)
	Adapter PCB for third party heater					BRP4A50	BRP4A50	BRP4A50A (4)
	External wired temperature sensor							
	Adapter PCB Mounting plate							

Notes

- (1) Do not connect the system to DIII-net devices LONWorks interface, BACnet interface, ...; (intelligent Touch Manager, EKMBDXA are allowed)
- (2) Installation box KRPIBA101 needed
- (3) Adapter PCB mounting plate needed, applicable model can be found in the table above
- (4) 3rd party heater and 3rd party humidifier cannot be combined
- (5) Installation box KRPS0-2A90 needed
- (6) Contains 1 plenum and can be used for half side of the unit (up to 4 plenums can be used on 1 unit)
- (7) Available only with optional plenum

Electrical heater for Modular L Smart

- › Total solution for fresh air with Daikin supply of both Modular L Smart and electrical heaters
- › Increase comfort in low outdoor temperature thanks to the heated outdoor air
- › Integrated electrical heater concept (no additional accessories required)
- › Standard dual flow and temperature sensor
- › Heater only consumes what is required to pre-heat to the desired minimum fresh air temperature; thus saving energy



Electrical heater for Modular L Smart (ALD)	02HEFB	03HEFB	05HEFB	07HEFB
Capacity kW	1,5	3	7,5	15
Connectable Modular L Smart size	02	03	04, 05	06, 07
Supply voltage	230V,1ph		400V,3ph	
Output current (maximum) (A)	6,6	13,1	10,9	21,7
Temperature sensor	15k ohms at -20 °C 10k ohms at +10 °C	16k ohms at -20 °C 10k ohms at +10 °C	17k ohms at -20 °C 10k ohms at +10 °C	18k ohms at -20 °C 10k ohms at +10 °C
Temperature control range	- 20 °C to 10 °C			
Control fuse	Mini Circuit Breaker 6 A			
LED indicators	"Yellow = Airflow fault Red = Heat ON"			
Mounting holes	Depends on duct size			
Maximum ambient adjacent to terminal box	30°C (during operation)			
Auto high temperature cutout	75°C Pre-set			
Manual reset high temperature cutout	120°C Pre-set			
Width (mm)	470	620	720	920
Depth (mm)	370	370	370	370
Height (mm)	193	243	343	443

Electrical heater for VAM

- › Total solution for fresh air with Daikin supply of both VAM and electrical heaters
- › Increased comfort in low outdoor temperature thanks to the heated outdoor air
- › Integrated electrical heater concept (no additional accessories required)
- › Standard dual flow and temperature sensor
- › Flexible setting with adjustable setpoint
- › Increased safety with 2 cut-outs: manual & automatic



		GSIEKA	10009	15018	20024	25030	35530 ⁽¹⁾
Capacity	kW		0.9	1.8	2.4	3.0	3.0
Duct diameter	mm		100	150	200	250	355
Connectable VAM			VAM150FC9	VAM250FC9	VAM350,500J	VAM650J, VAM800J, VAM1000J	VAM1500J, VAM2000J

		GSIEKA10009	GSIEKA15018	GSIEKA20024	GSIEKA25030	GSIEKA35530	
Dimensions	Height	mm	171	221	271	321	426
	Depth	mm	100	150	200	250	355
	Width	mm	370	370	370	370	373
Minimum air velocity / airflow		m/s	1.5				
		m ³ /h	45	100	170	265	535
Power supply		1~230 VAC/50Hz					
Nominal current	A	4.1	8.2	10.9	13.1	13.1	
Heating power	kW	0.9	1.8	2.4	3.0	3.0	
Connection duct diameter	mm	100	150	200	250	355	
Operation range	Min.	°C	-40°C				
	Max.	°C	40°C				
	Rel. Humidity	%	90%				
Temperature sensor		10 kΩ at +25°C / TJ-K10K					
Temperature sensor range		- 30°C to 105°C					
Temperature set point range		- 10°C to 50°C					
LED indicators	LED 1	flashing every 5 seconds	heater is starting up				
		flashing every second	air flow detected, heating allowed				
		OFF	no power supply or no flow				
	LED 2	ON	problem with duct temperature sensor, set point potentiometer or PTC airflow sensor				
		OFF	heater is not operation				
		ON	heater is operating				
Ambient temperature adjacent to controller		0°C to +50°C					
Auto high temperature cut-out		50°C					
Manual reset high temperature cut-out		100°C					

We're here to help you!
Online and offline

The image shows a comprehensive view of the DAIKIN design tool. The top part is a web-based interface with a navigation menu (Project, Units, Piping, Wiring, Controllers, Controller wiring, Reports) and a search bar. The main area displays a detailed wiring diagram for 'Floor 1 REYQ18T', showing a central outdoor unit (KHRQ23MSAT) connected to several indoor units (Ind 1-FXDC50A, Ind 2-FXZQ40A, Ind 3-FXFQ40A, Ind 4-FXNG40A, Ind 5-FXKQ200MA, Ind 7-FXFQ40A) and a control panel (BS1 BSAQ1AA). Cable specifications like '10.0m' and '15.9x26.6x22.2mm' are shown. Below the diagram is a laptop displaying the DAIKIN website with a search bar and various product categories.

<http://literature.daikinpromoshop.eu>

This block contains two screenshots of the DAIKIN design tool software. The top screenshot shows a complex wiring diagram with multiple units and connections. The bottom screenshot shows a 3D model of a DAIKIN outdoor unit with various configuration options and a 'Properties' panel on the right side.

The image shows the cover of the 'General catalogue 2018'. It features the DAIKIN logo at the top left, the title 'General catalogue 2018' in a blue box, and a photograph of a man in a white shirt looking at a laptop. The cover is decorated with various product icons like a fan, a remote control, and a Wi-Fi symbol.

Tools and platforms

Literature overview	50
Supporting tools, software and apps	52

Commercial market - literature overview

for professional network

Solution guides:

Reference books:



Product profiles:



VRV IV i-series
Main benefits, application examples and specs of VRV IV i-series product range
207



Sky Air A-series
Main benefits and specs
116



Water-to-air heat pump
Detailed info on VRV IV W-series, application examples, technical system design background
209



VRV IV S-series
Main benefits, application examples and specs of VRV IV S-series product range
208

Focus topics:



Replacement Technology
Clear installer benefits of VRV replacement technology
214



Infrastructure cooling
Clear installer benefits why to choose Daikin for infrastructure cooling
140



F-gas phase down
Clear explanation of the phase down targets and how Daikin takes the lead in meeting these
605

Product flyers:



Madoka
Detailed info on the Madoka wired remote controllers
306



Daikin Cloud Service
Detailed info on the Daikin Cloud Service packages
542



Mini Sky Air Alpha-series
Detailed info on the RZAG-A outdoor unit
146



Sky Air Alpha-series
Detailed info on the RZAG-NV1/NY1 outdoor units
147



Sky Air Advance-series
Detailed info on the RZA-D outdoor units
148

Product catalogues:



Sky Air Catalogue
Detailed technical information & benefits on Sky Air/Ventilation/Biddle Air Curtain/Control systems/AHU
100



VRV Catalogue
Detailed technical information & benefits of the VRV total solution
200

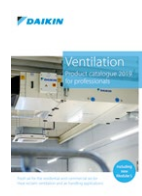

Ventilation Catalogue
Detailed info on Ventilation products
203

for your customers



Commercial Solutions
Daikin offers solutions for commercial applications

100

Reference catalogue

Daikin commercial and industrial references

213



Green Building Solutions

Clear building owner/investor benefits why to choose Daikin for a green building, with emphasis on BREEAM

216



Hotel Solutions

Clear building owner/investor benefits why to choose Daikin for a hotel

218

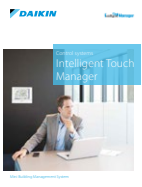

Compressor retrofit
VRV retrofit services

547

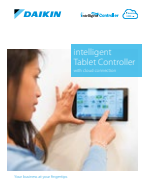

DCC601A51
Detailed benefits of DCC601A51 and Daikin Cloud Service

303



Compressor retrofit
VRV retrofit services

547



Technical documentation:

All latest Daikin catalogues are available in a convenient library on the internet:
www.daikineurope.com/support-and-manuals/catalogues

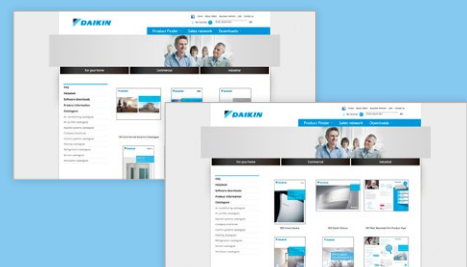

Supporting tools, software and apps

www.daikineurope.com/support-and-manuals/software-downloads

Web based Xpress selection software

Making selection easy, anytime, anywhere

- › Web & cloudbased access to your projects from anywhere, at any time...
- › Platform (Windows, Mac, ...) and hardware (laptop, desktop, tablet) independent
- › Re-engineered GUI for maximum easy of use
- › No need to do local installation
- › No tool updates required (always latest version available)
- › Possibility to copy / share projects

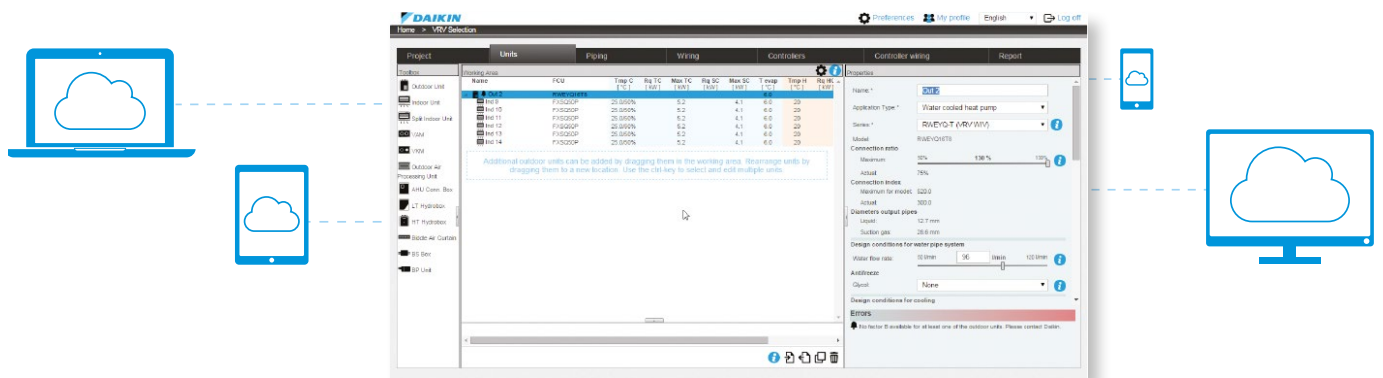

Easy selection, anytime, anywhere

Main functions

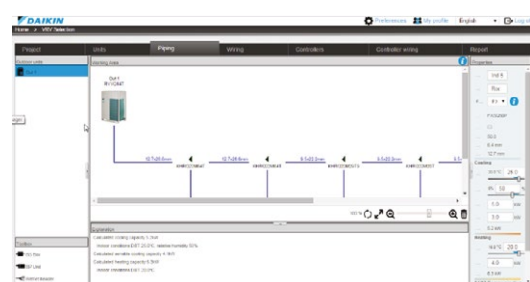

Easy editing of piping

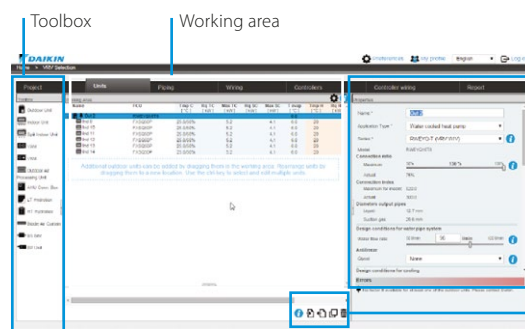

Intuitive interface

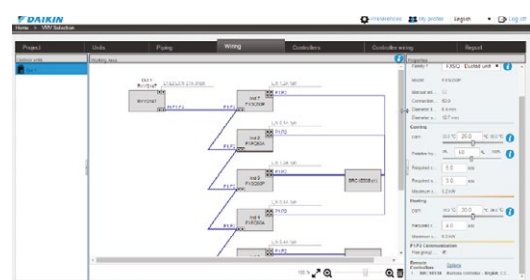

Clear wiring overview, easy to make control groups

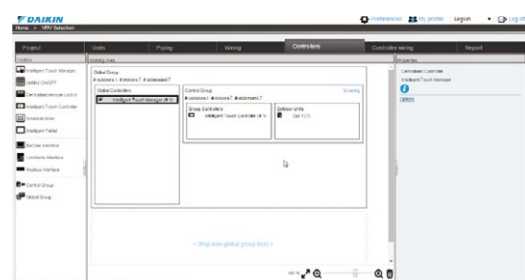

Clear overview of control groups and central controls

Other selection software

VRV Pro

Enables VRV air conditioning systems to be engineered in a precise and economical way, taking into account the complex piping rules. Moreover, it ensures optimum operating cycles and maximum energy efficiency.

- › Accurate heat load calculation
- › Precise selection based on peak loads
- › Energy consumption indication

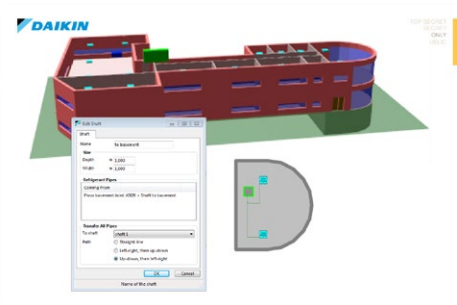

Ventilation Xpress

Selection tool for ventilation devices (VAM, VKM).

The selection is based on given supply/extract airflows (including fresh up and given ESP of supply/extract ducting):

- › Determines size of electrical heaters
- › Visualisation of psychrometric chart
- › Visualisation of selected configuration
- › Required field settings mentioned in the report

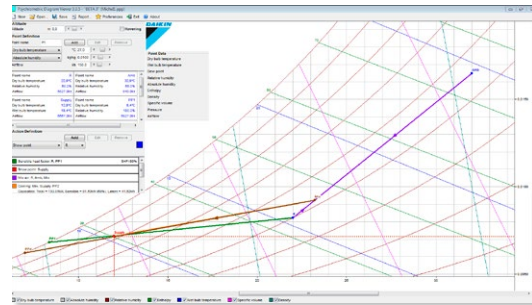

Webbased ASTRA selection for air handling units

A powerful tool to select the right Air Handling Units for your needs.

- › 3D interface
- › quick selection procedures
- › new print-out possibilities and report shapes



WAGO selection tool

The WAGO Selection Tool is specifically designed to select the optimal WAGO I/O system for your needs.

- › Easy selection of WAGO materials
- › Material list creation
- › Time saving
 - Includes wiring schemes
 - Contains commissioning/preset data for

Intelligent touch Manager



Plug-ins and third-party software tools

Building Information Modelling (BIM) support

- › BIM improves efficiency of design and build phase
- › Daikin is among the first to supply a full library of BIM objects for its VRV products

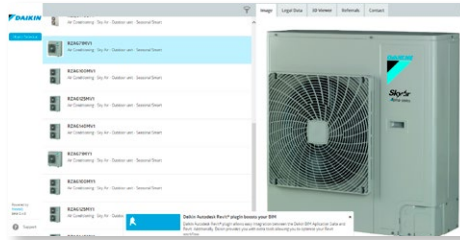

www.daikin.eu/bim

VRV CAD 2D

- › Displays VRV pipe design on a Autocad 2D floorplan
- › Improves project management
- › Accurately calculates the pipe dimensions and refnets
- › Determines the outdoor unit size
- › Validates VRV pipe rules
- › Accounts for the extra refrigerant charge, including a max room concentration check

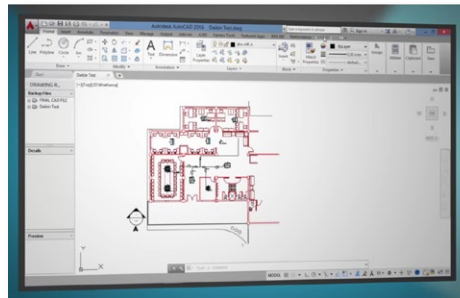

<http://www.daikineurope.com/autocad/index.jsp>

Energy simulation and design aid tools

Seasonal simulator

- › The Seasonal Simulator is an innovative software tool that calculates and compares potential seasonal efficiency ratings.
- › This user-friendly tool compares various Daikin systems, annual power consumption, CO₂ emissions, and much more, to present an accurate ROI calculation in a matter of minutes.



Psychrometrics diagram

- › The Psychrometrics Diagram Viewer demonstrates the changing properties of moist air.
- › With this tool, users can choose two points with specific conditions, plot them on the diagram and select actions to change the conditions, i.e. heat, cool and mix air.

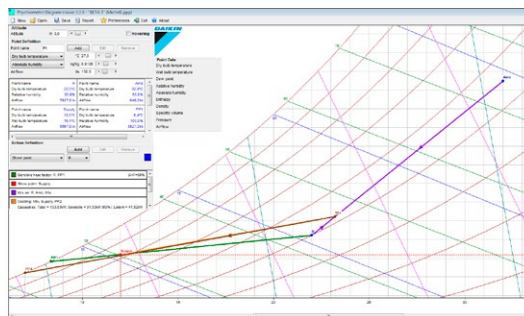

Service tools

Error code app

Quickly know the meaning of fault codes, for each product family and the potential cause



D-Checker

D-checker is a software application used to record and monitor operation data of Daikin applied, split, Multi-split, Sky-air units, Daikin Altherma LT, ground source heat pump, Hybrid, ZEAS, Conveni-pack & R410A Booster unit



Bluetooth adaptor

Monitoring of Split, Sky Air and VRV data via any bluetooth device

- › No need to access the outdoor unit
 - Connects with D-Checker software (for laptops)
 - Connects with monitoring app (for tablets or smartphones)

Diagnosis of the Bluetooth system possible:



VRV Service-Checker

- › Connected via F1/F2 bus to check multiple systems at the same time
- › Connection of external pressure sensors possible

Online support

Business portal

- › Experience our new extranet that thinks with you at my.daikin.eu
- › Find information in seconds via a powerful search
- › Customise the options so you see only info relevant for you
- › Access via mobile device or desktop

my.daikin.eu



Internet

Find our solution for different applications:

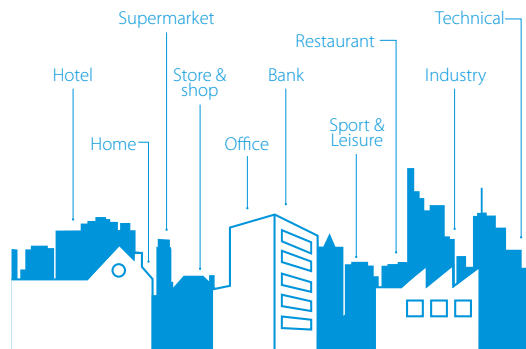

- › Get more commercial details on our flagship products via our dedicated minisites
- › See our references



www.daikineurope.com/references



Technical drawings

ALB-RBS / LBS

58

VAM-FC9/J
VKM-GB(M)

64



ALB04RBS/LBS

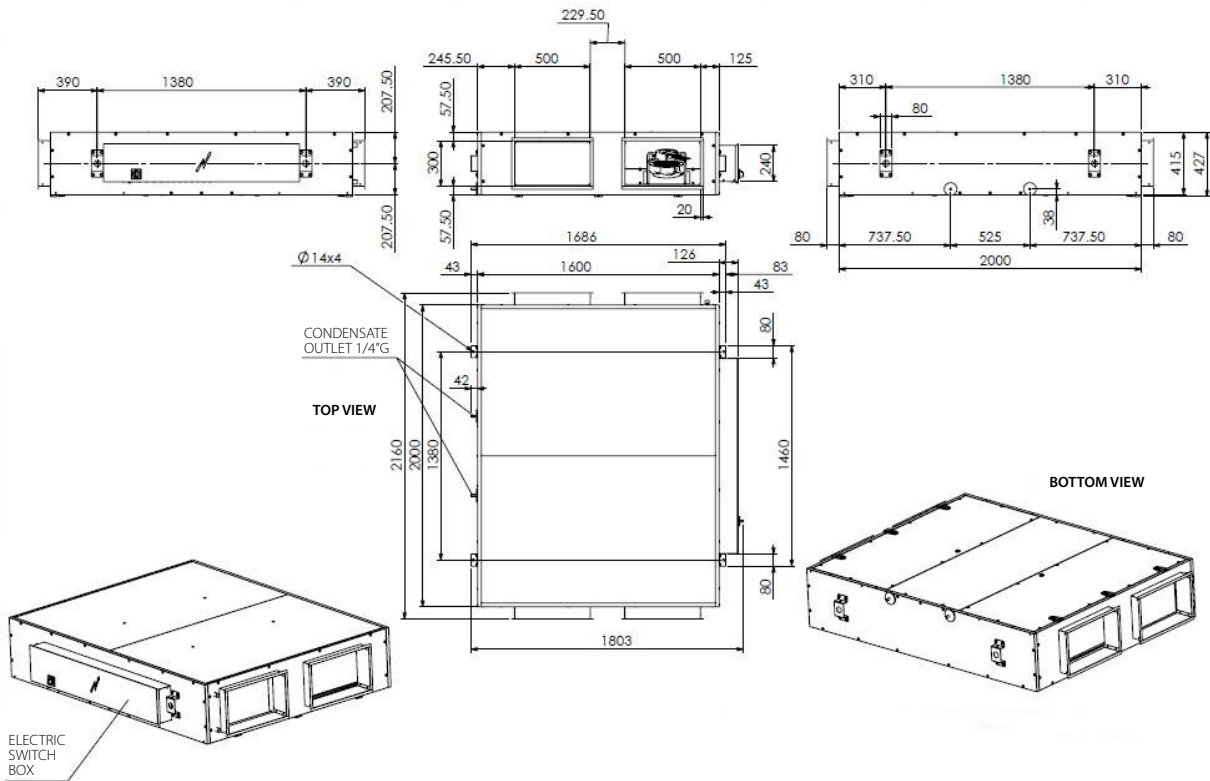

ALB05RBS/LBS

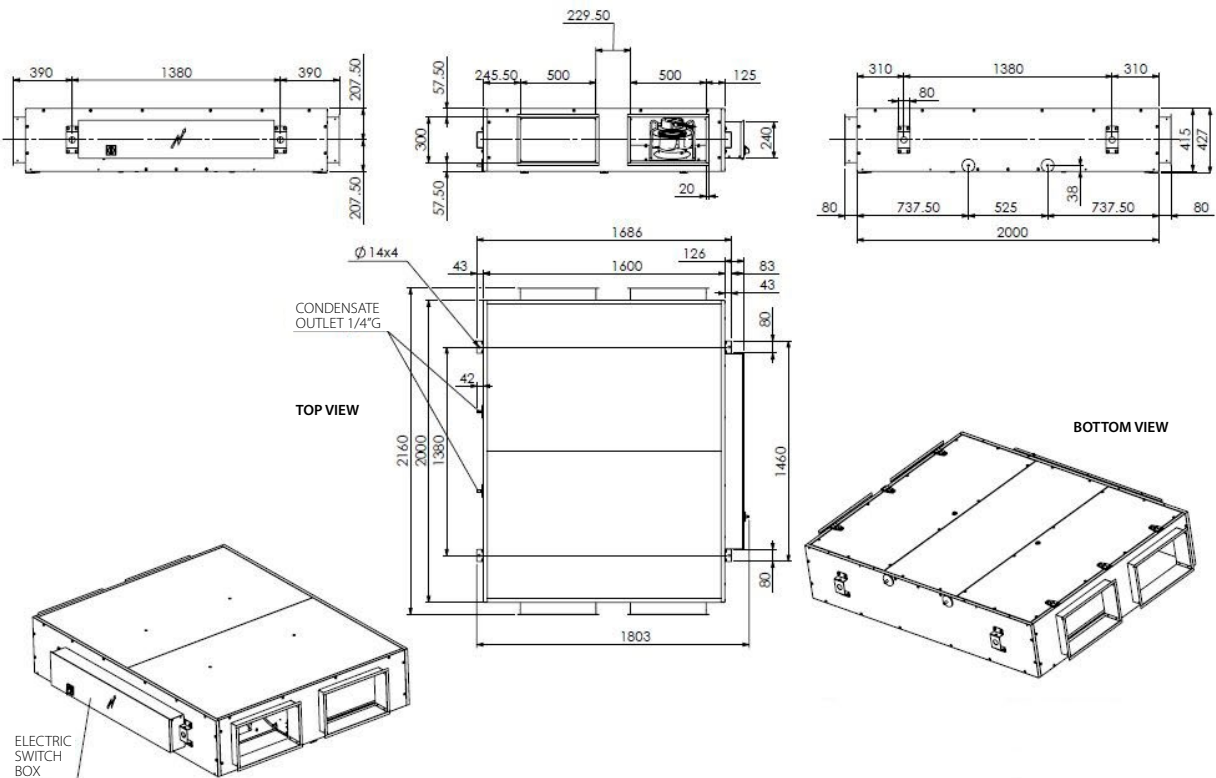



ALB02RBS/LBS

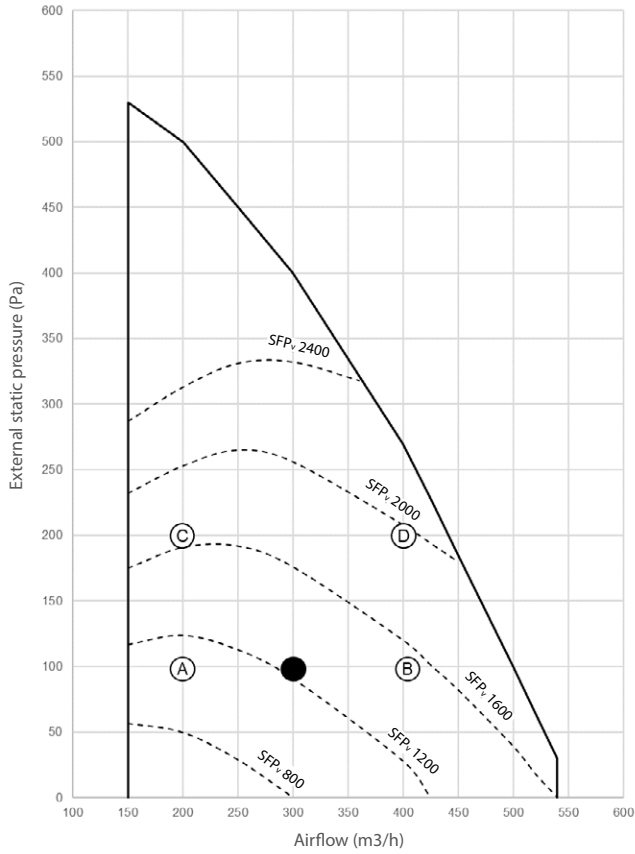

The diagram shows the available external pressure for the duct system given an airflow.

SFP_v = Specific Fan Power (W/m³/s)

The SFP_v curves are referring to the complete unit. Moreover, it includes power to both supply and extract fan divided by either the supply or extract volume whichever is the greater.

● Nominal working point

ALB03RBS/LBS

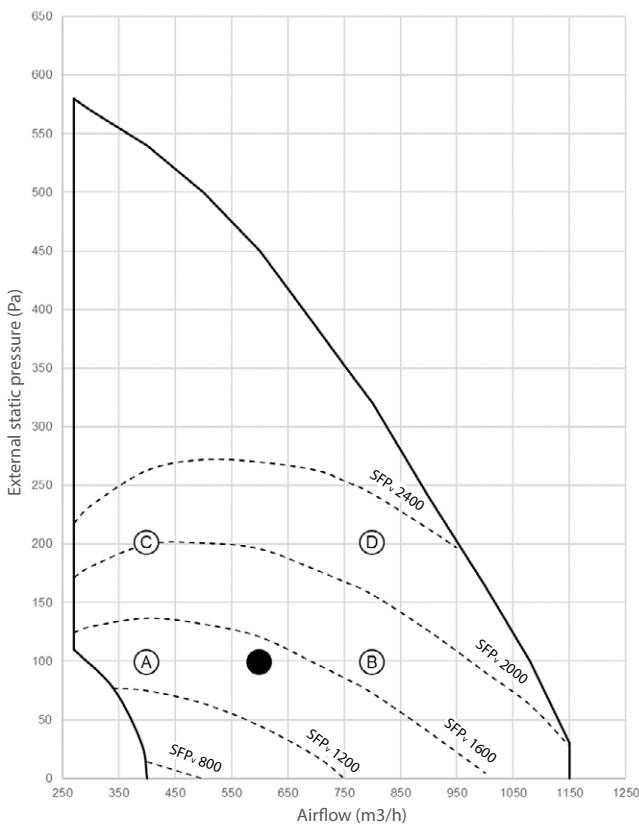

The diagram shows the available external pressure for the duct system given an airflow.

SFP_v = Specific Fan Power (W/m³/s)

The SFP_v curves are referring to the complete unit. Moreover, it includes power to both supply and extract fan divided by either the supply or extract volume whichever is the greater.

● Nominal working point



ALB04RBS/LBS

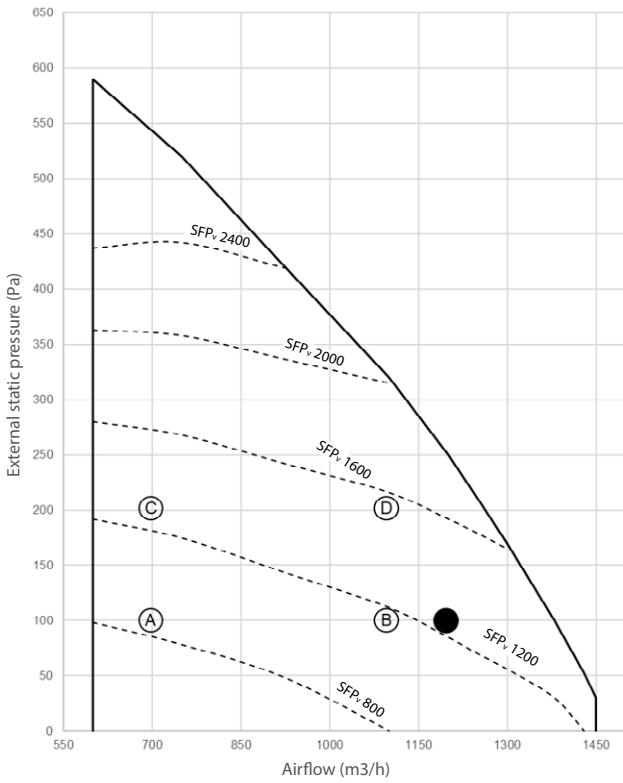

The diagram shows the available external pressure for the duct system given an airflow.

SFPv = Specific Fan Power (W/m3/s)

The SFPv curves are referring to the complete unit. Moreover, it includes power to both supply and extract fan divided by either the supply or extract volume whichever is the greater.

● Nominal working point

ALB05RBS/LBS

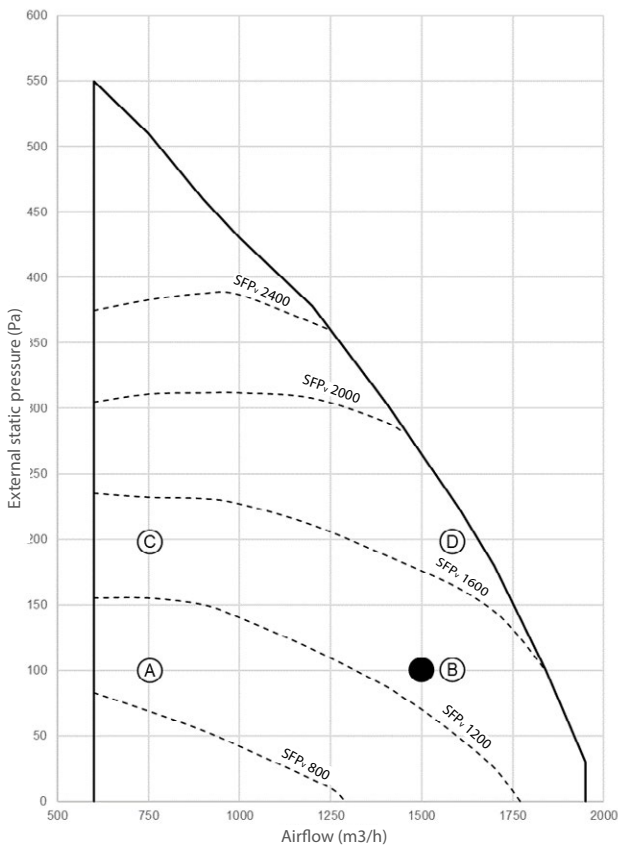

The diagram shows the available external pressure for the duct system given an airflow.

SFPv = Specific Fan Power (W/m3/s)

The SFPv curves are referring to the complete unit. Moreover, it includes power to both supply and extract fan divided by either the supply or extract volume whichever is the greater.

● Nominal working point



ALB06RBS/LBS

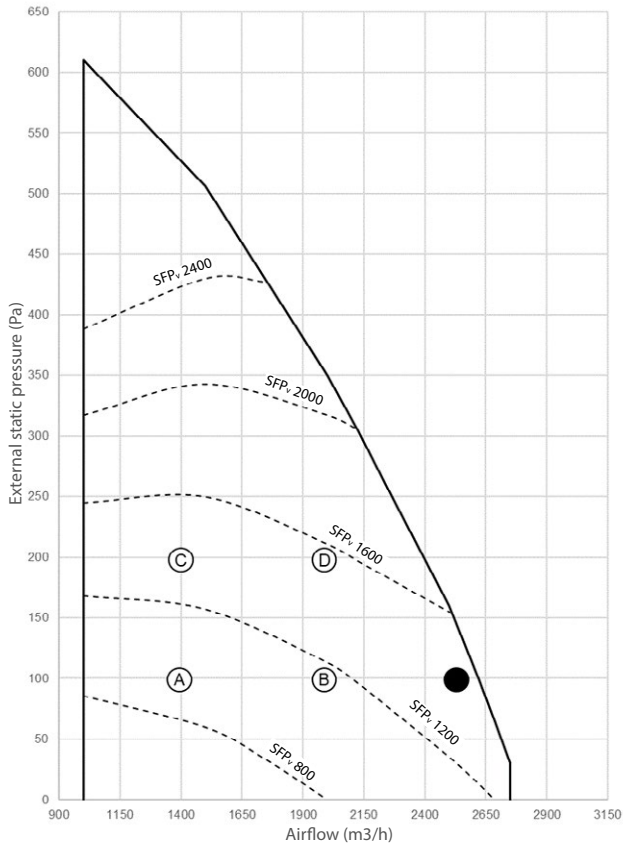

The diagram shows the available external pressure for the duct system given an airflow.

SFPv = Specific Fan Power (W/m³/s)

The SFPv curves are referring to the complete unit. Moreover, it includes power to both supply and extract fan divided by either the supply or extract volume whichever is the greater.

● Nominal working point

ALB07RBS/LBS

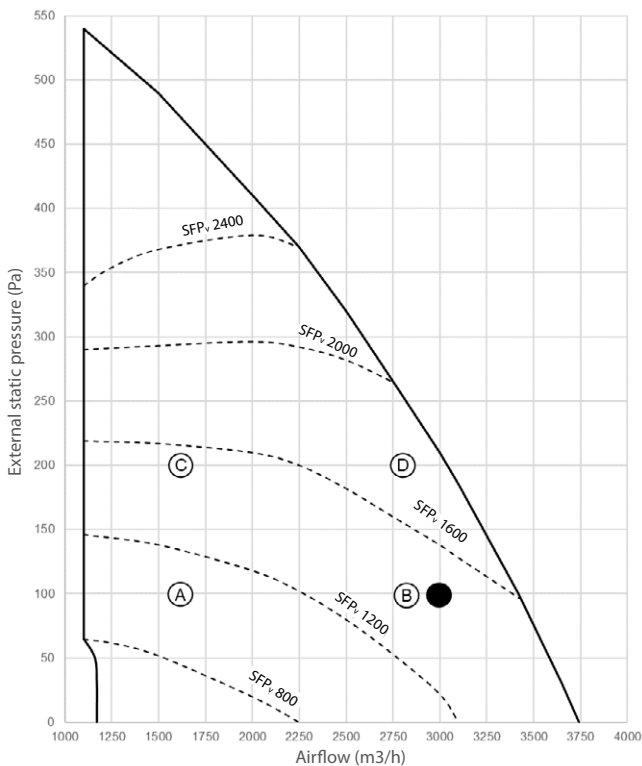

The diagram shows the available external pressure for the duct system given an airflow.

SFPv = Specific Fan Power (W/m³/s)

The SFPv curves are referring to the complete unit. Moreover, it includes power to both supply and extract fan divided by either the supply or extract volume whichever is the greater.

● Nominal working point



Detailed technical drawings

VAM150FC9

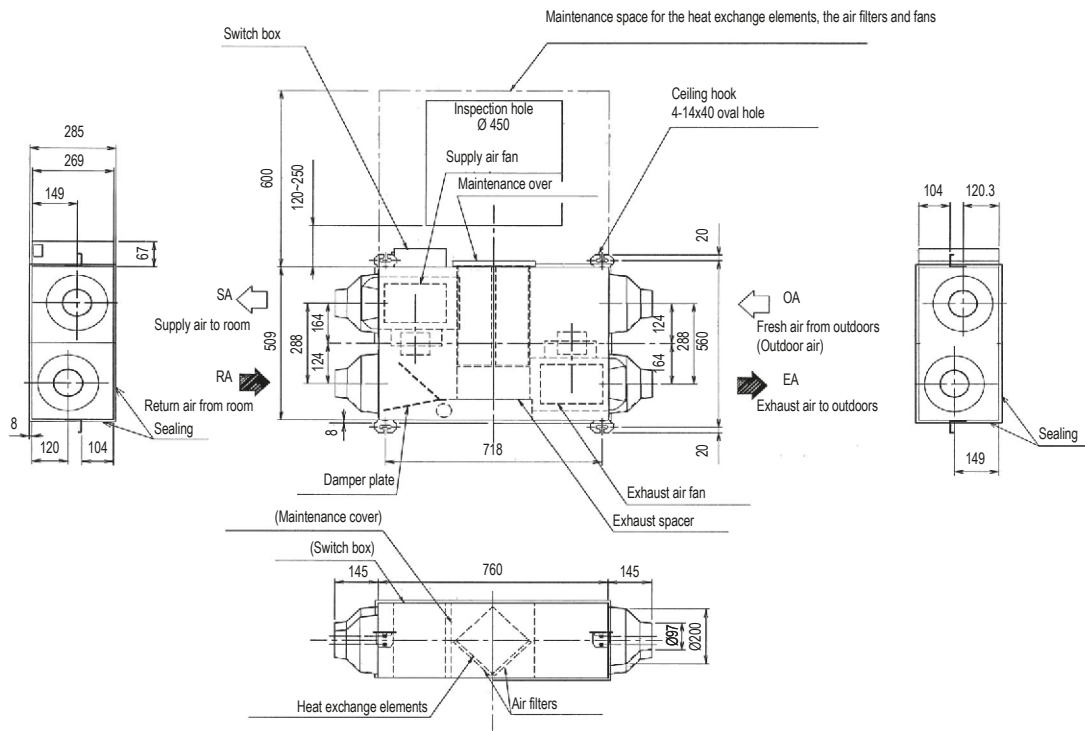

NOTE

- 1 Be sure to provide the inspection hole (450x450 mm) to inspect the air filters, the exchange elements and fans.

3TW27874-1

VAM250FC9

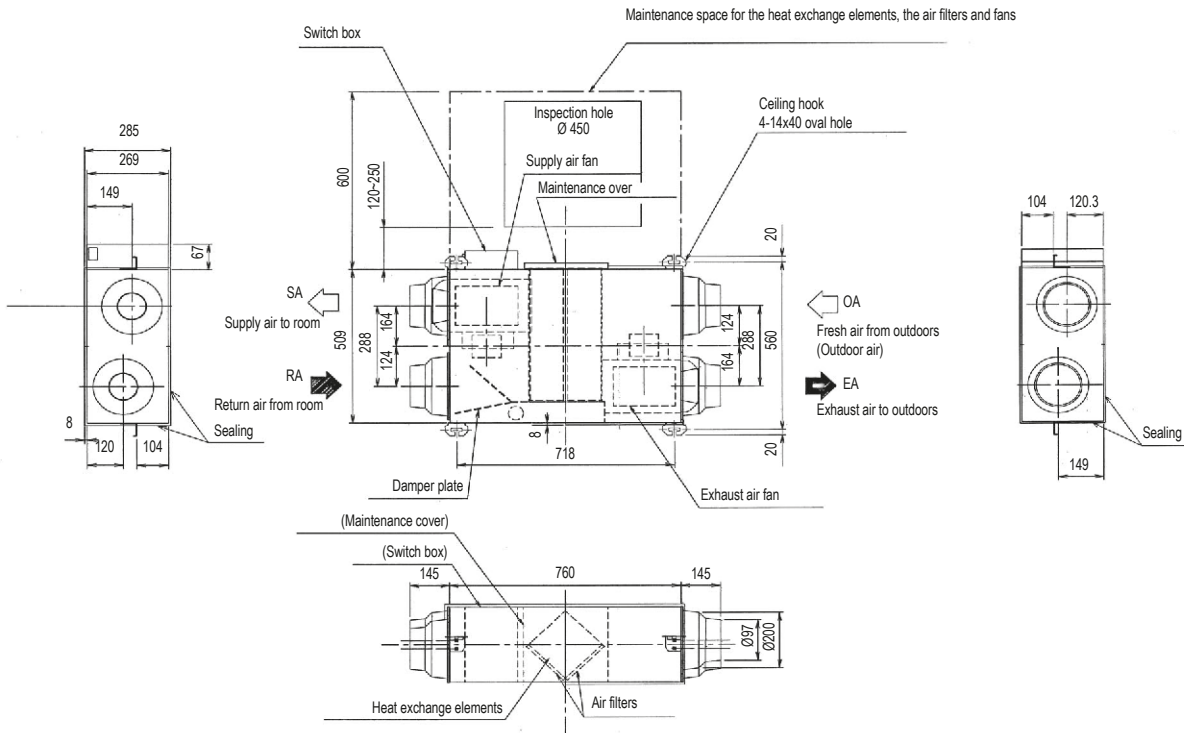

NOTE

- 1 Be sure to provide the inspection hole (450x450 mm) to inspect the air filters, the exchange elements and fans.

3TW27884-1



VAM350-500J

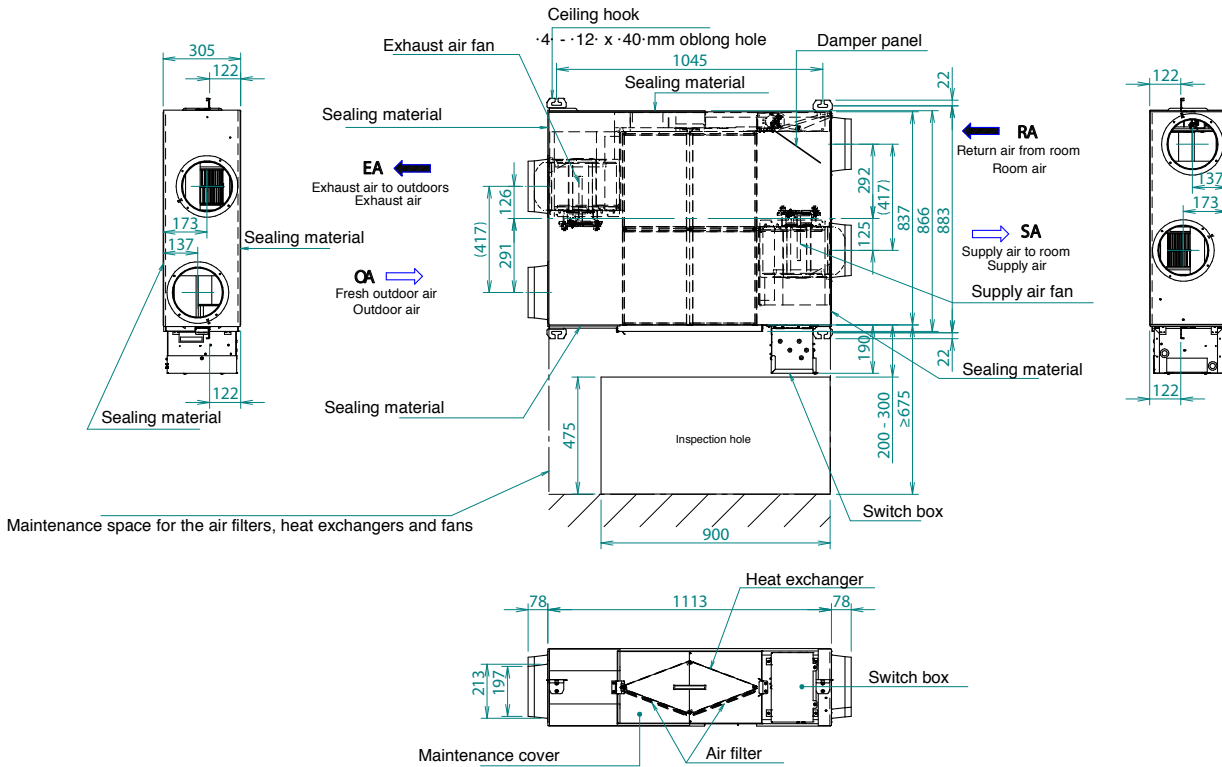

Notes :

1. To allow for the inspection of the air filters, heat exchangers, and fans, be sure to provide the inspection hole.

3D112815C

VAM650J

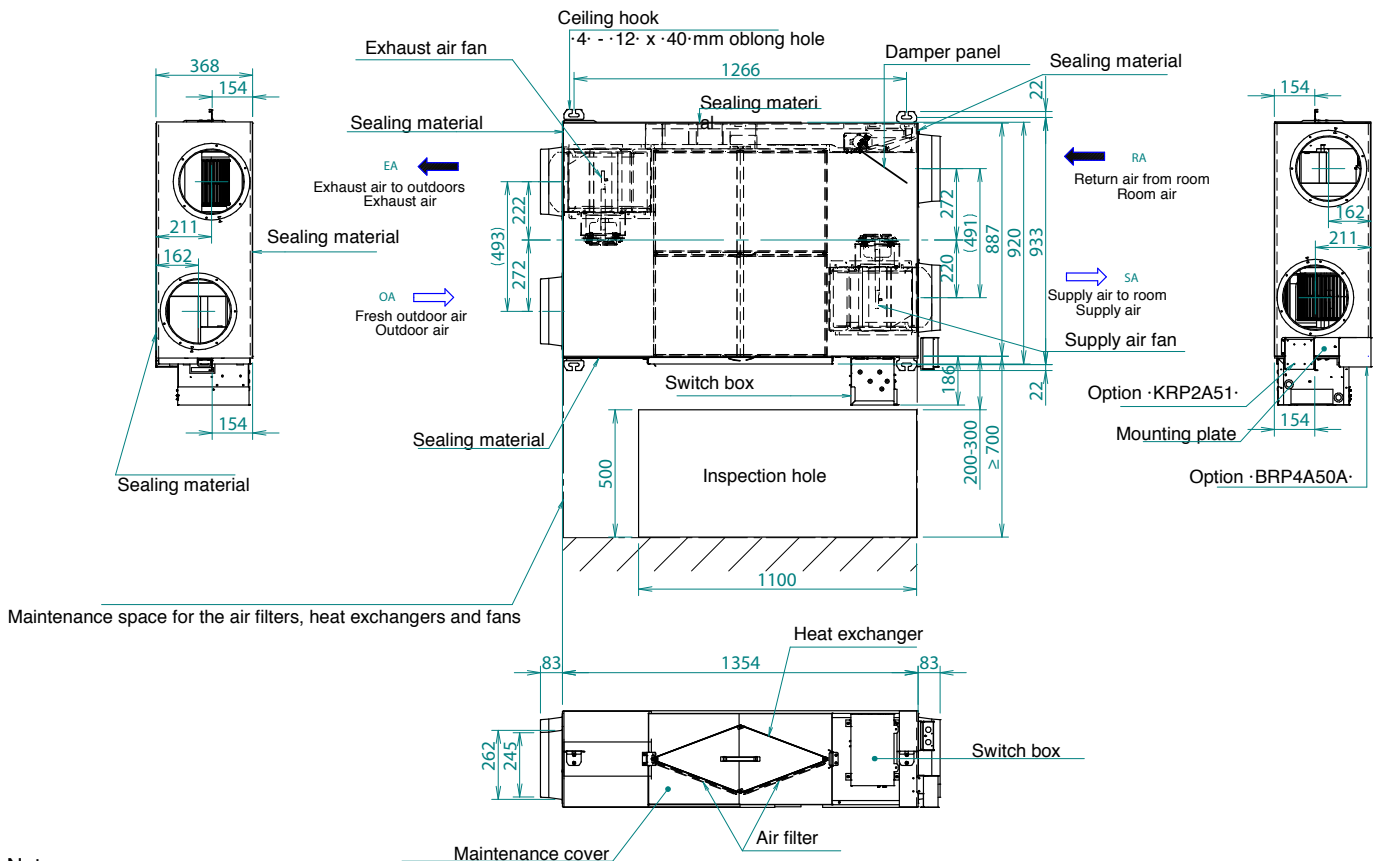

Notes :

1. To allow for the inspection of the air filters, heat exchangers, and fans, be sure to provide the inspection hole.

3D113502A



Detailed technical drawings

VAM800-1000J

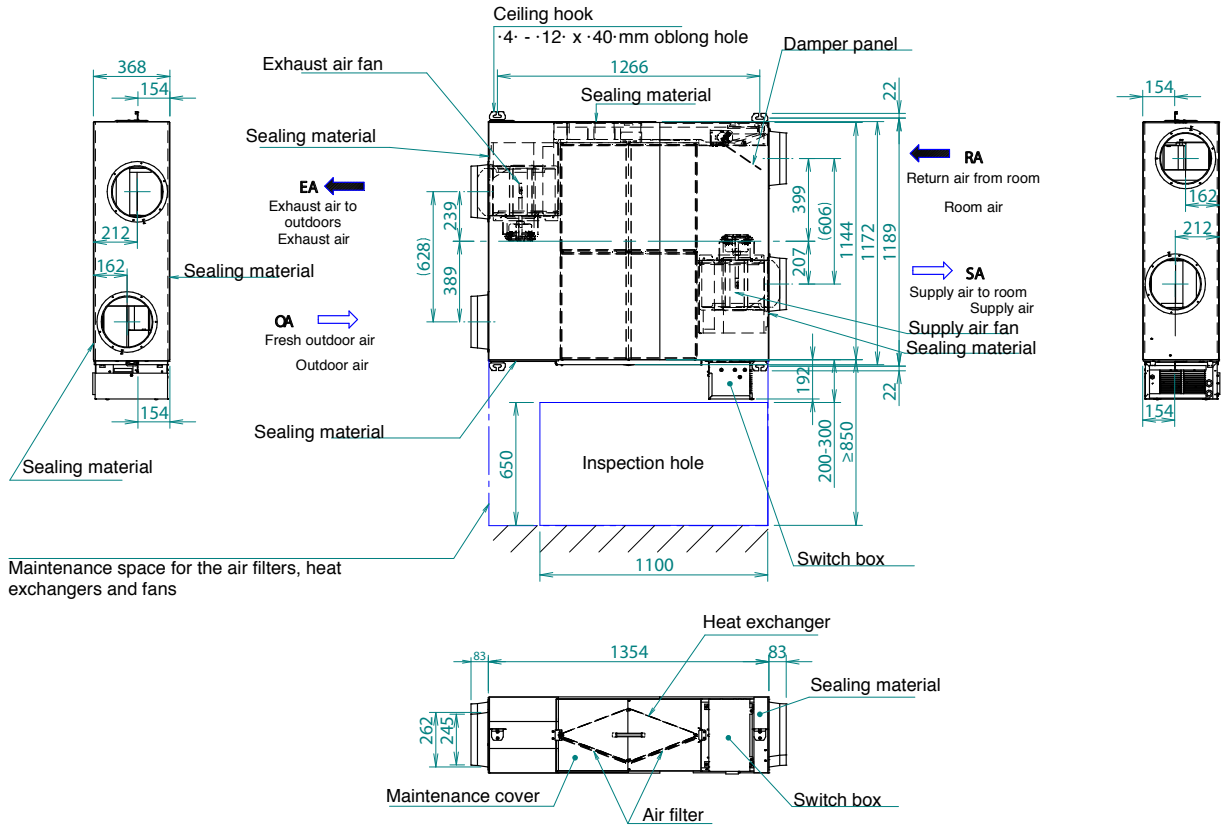

Notes:

- 1. To perform maintenance on the air filter, it is required to provide a service access panel.

3D112817D

VAM1500-2000J

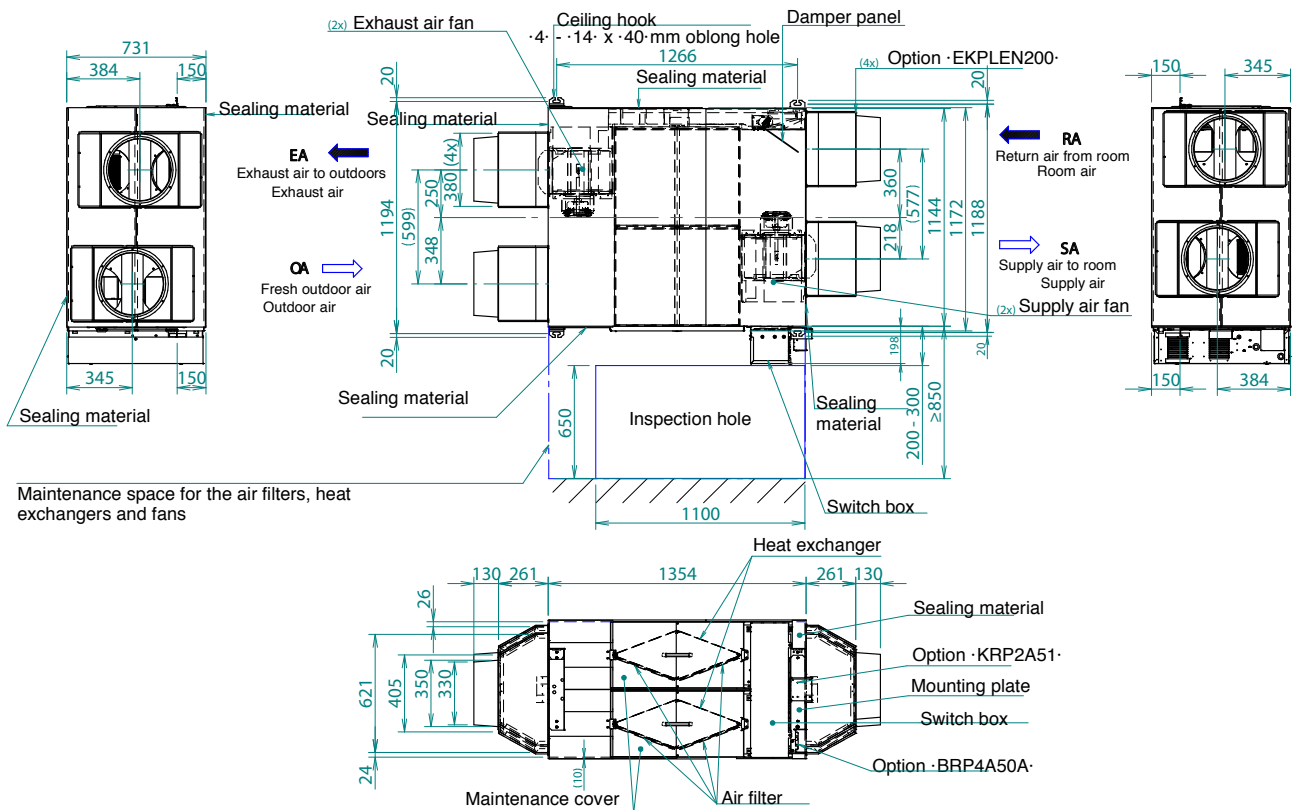

Notes:

- 1. To allow for the inspection of the air filters, heat exchangers, and fans, be sure to provide the inspection hole.

3D112818C



VAM150FC9

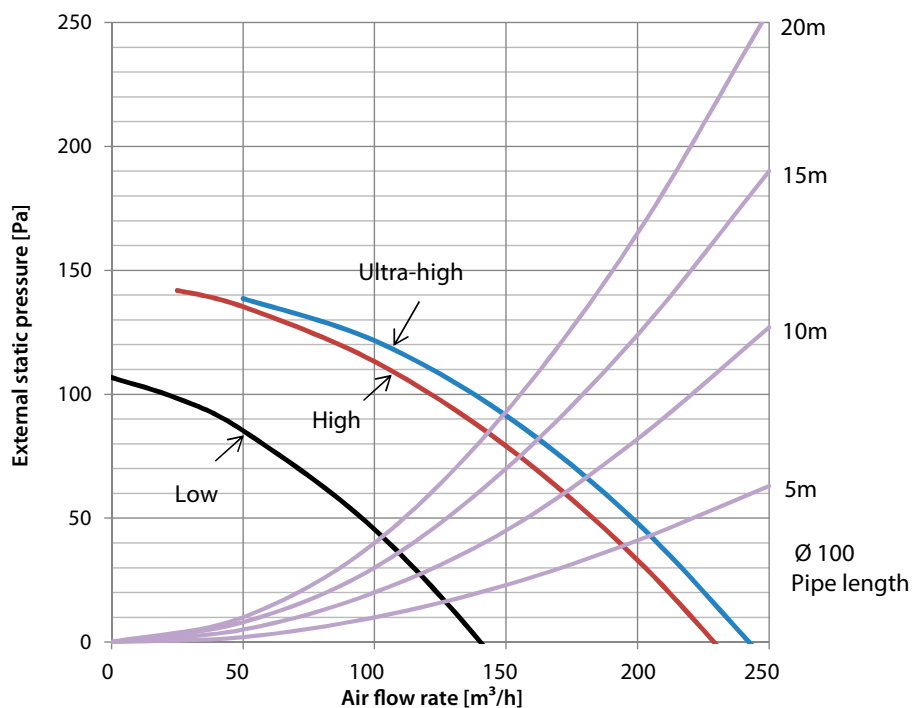

Notes

1. The fan speeds are valid for ~230-V, ~50-Hz power supply.

4D100379

VAM250FC

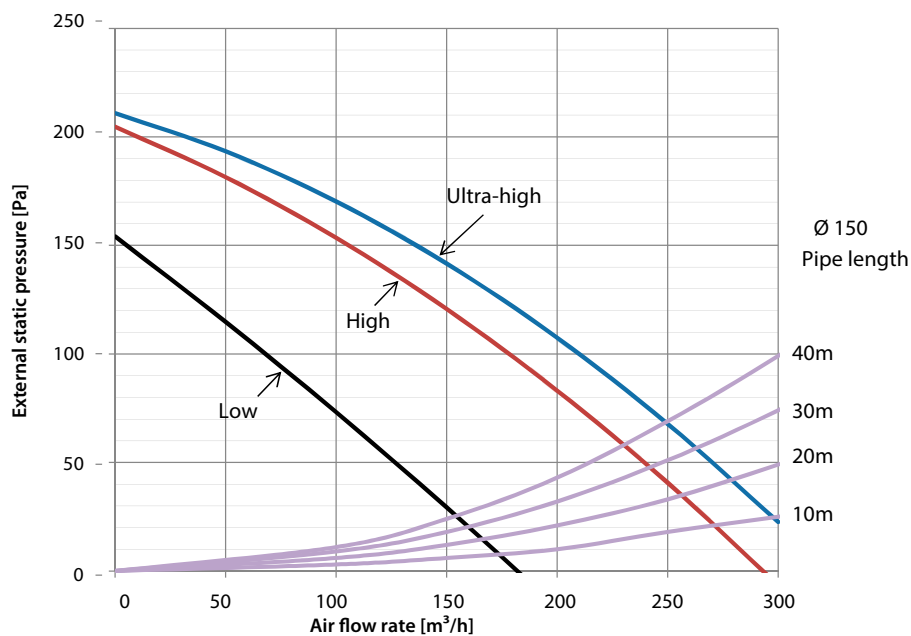

Notes

1. The fan speeds are valid for ~230-V, ~50-Hz power supply.

4D100380



Detailed technical drawings

VAM350J

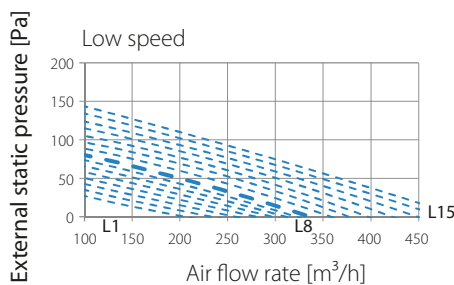
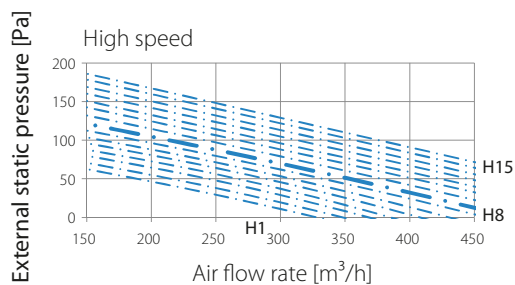
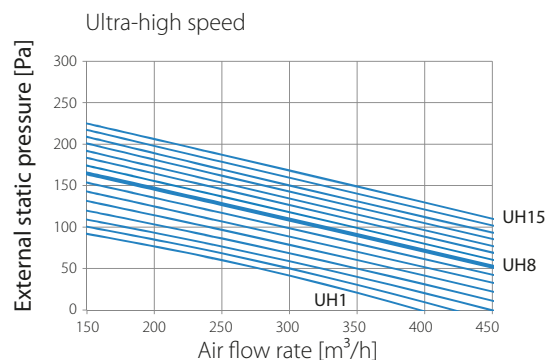
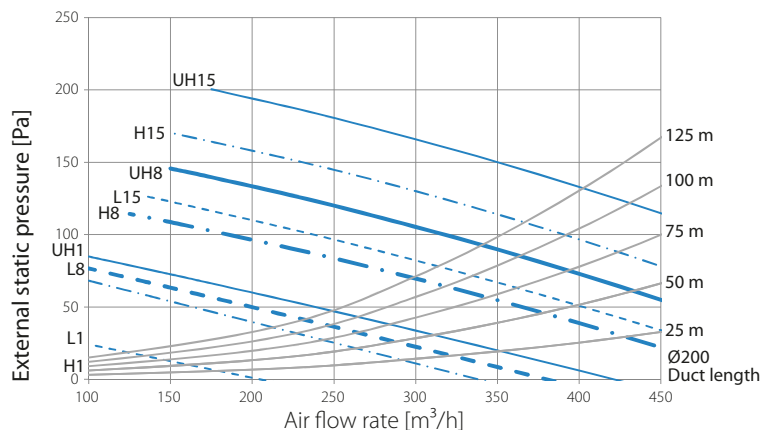

— Ultra-high speed
 - · - · High speed
 - - - Low speed

Notes

- The fan curves are determined with $\cdot 1/3$ of the ESP on the outdoor side (EA & OA), and $\cdot 2/3$ of the ESP on the indoor side (RA & SA).
 EA = Exhaust air
 OA = Outdoor air
 RA = Room air
 SA = Supply air
- Measured according to JIS B 8628 - 2003.

Legend

- L1 = Low speed lower limit
- L8 = Low speed factory setting
- L15 = Low speed upper limit
- H1 = High speed lower limit
- H8 = High speed factory setting
- H15 = High speed upper limit
- UH1 = Ultra-high speed lower limit
- UH8 = Ultra-high speed factory setting
- UH15 = Ultra-high speed upper limit

3D113493A

VAM500J

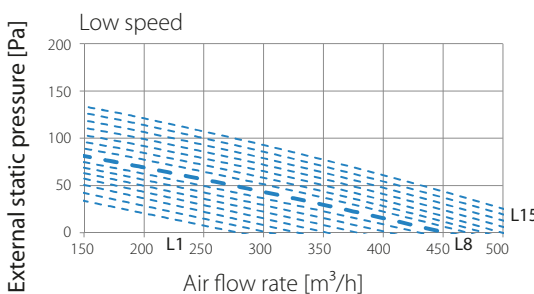
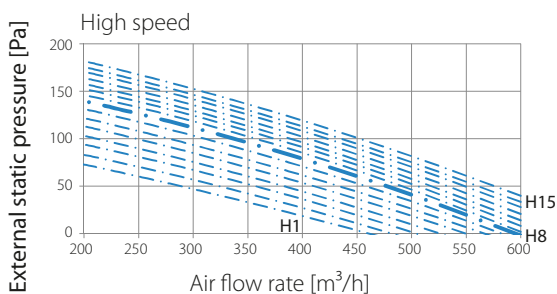
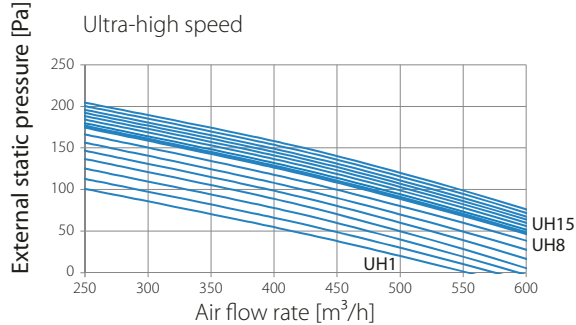
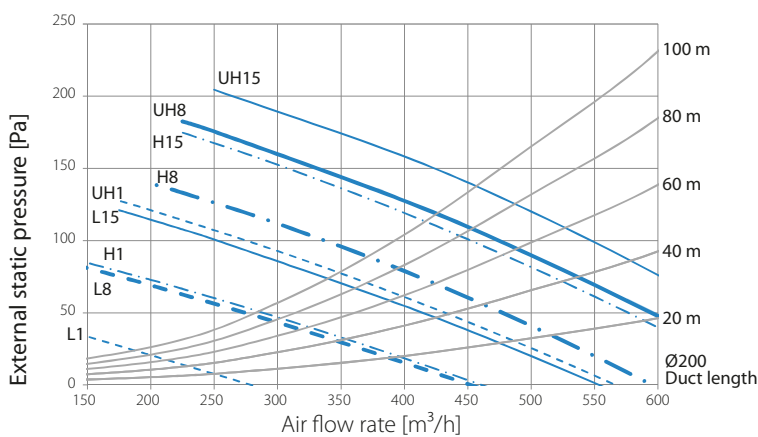

— Ultra-high speed
 - · - · High speed
 - - - Low speed

Notes

- The fan curves are determined with $\cdot 1/3$ of the ESP on the outdoor side (EA & OA), and $\cdot 2/3$ of the ESP on the indoor side (RA & SA).
 EA = Exhaust air
 OA = Outdoor air
 RA = Room air
 SA = Supply air
- Measured according to JIS B 8628 - 2003.

Legend

- L1 = Low speed lower limit
- L8 = Low speed factory setting
- L15 = Low speed upper limit
- H1 = High speed lower limit
- H8 = High speed factory setting
- H15 = High speed upper limit
- UH1 = Ultra-high speed lower limit
- UH8 = Ultra-high speed factory setting
- UH15 = Ultra-high speed upper limit

3D113494A



VAM650J

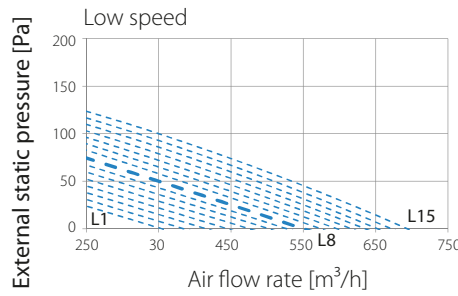
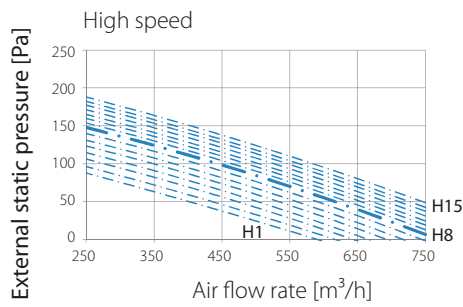
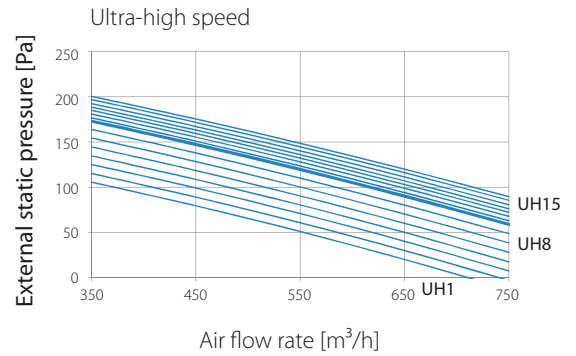
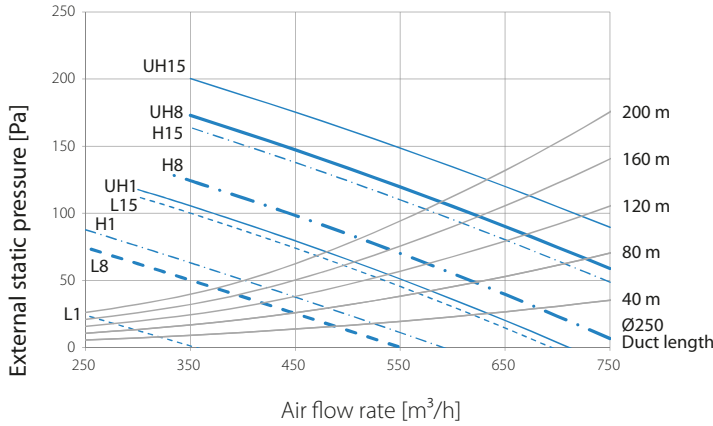

— Ultra-high speed
 - - - High speed
 - - - Low speed

Notes

- The fan curves are determined with 1/3 of the ESP on the outdoor side (EA & OA), and 2/3 of the ESP on the indoor side (RA & SA).
 EA = Exhaust air
 OA = Outdoor air
 RA = Room air
 SA = Supply air
- Measured according to JIS B 8628 - 2003.

Legend

- L1 = Low speed lower limit
- L8 = Low speed factory setting
- L15 = Low speed upper limit
- H1 = High speed lower limit
- H8 = High speed factory setting
- H15 = High speed upper limit
- UH1 = Ultra-high speed lower limit
- UH8 = Ultra-high speed factory setting
- UH15 = Ultra-high speed upper limit

3D113495A

VAM800J

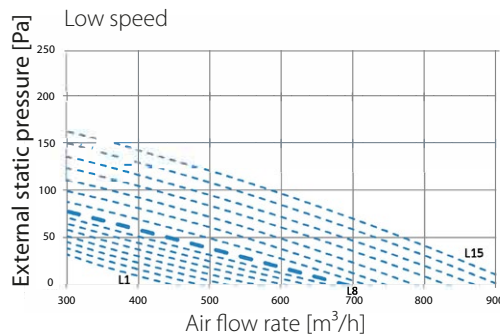
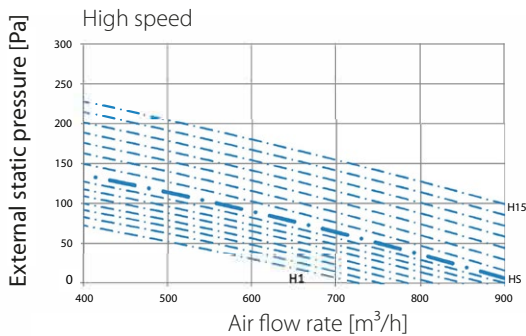
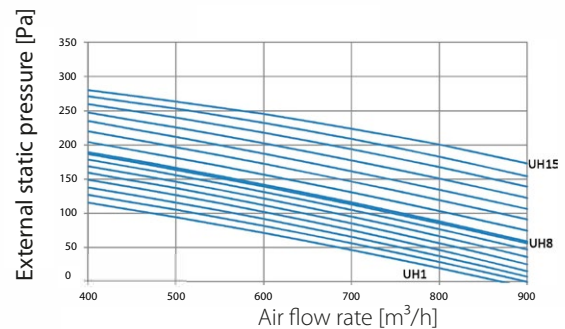
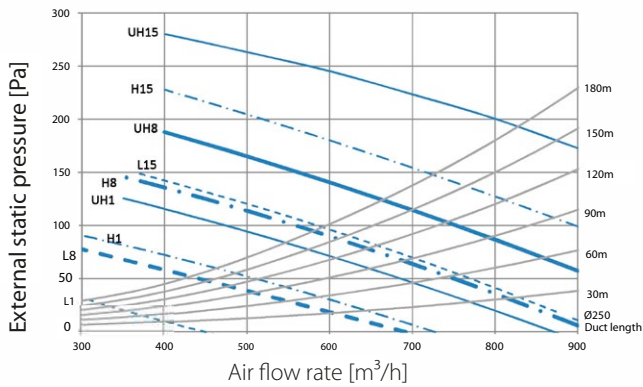

— Ultra-high speed
 - - - High speed
 - - - Low speed

Notes

- The fan curves are determined with 1/3 of the ESP on the outdoor side (EA & OA), and 2/3 of the ESP on the indoor side (RA & SA).
 EA = Exhaust air
 OA = Outdoor air
 RA = Room air
 SA = Supply air
- Measured according to JIS B 8628 - 2003.

Legend

- L1 = Low speed lower limit
- L8 = Low speed factory setting
- L15 = Low speed upper limit
- H1 = High speed lower limit
- H8 = High speed factory setting
- H15 = High speed upper limit
- UH1 = Ultra-high speed lower limit
- UH8 = Ultra-high speed factory setting
- UH15 = Ultra-high speed upper limit

3D112837



Detailed technical drawings

VAM1000J

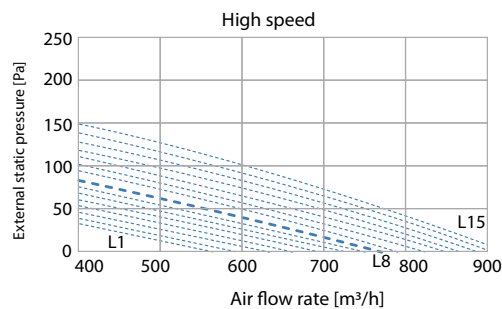
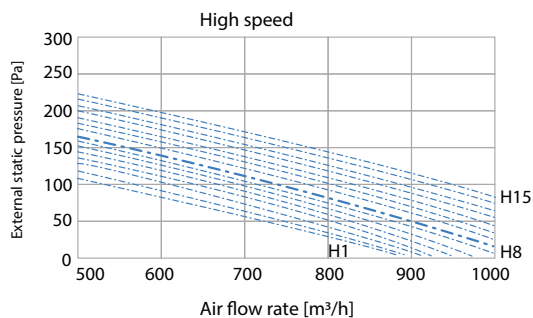
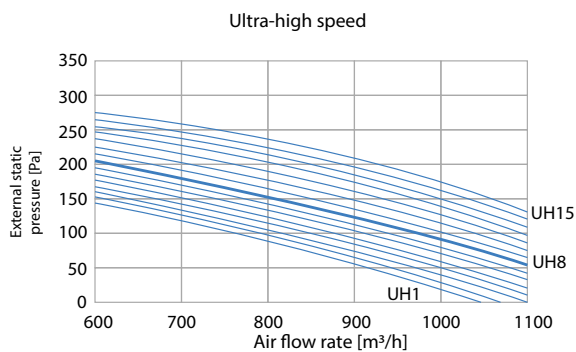
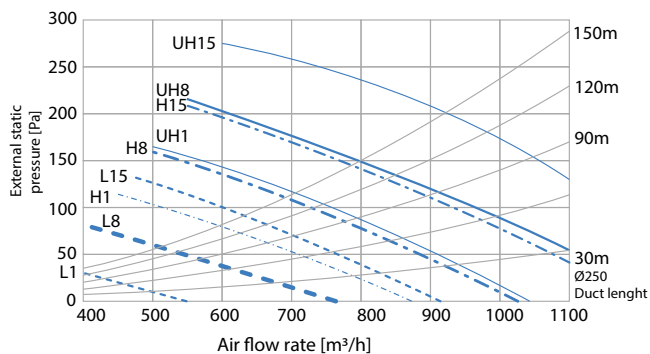

Notes

1. The fan curves are determined with $\cdot 1/3$ - of the ESP on the outdoor side (-EA & OA-), and $\cdot 2/3$ - of the ESP on the indoor side (-RA & SA).

EA= Exhaust air
OA = Outdoor air
RA= Room air
SA= Supply air

— Ultra-high speed
- - - High speed
- - - Low speed

Legend

L1 = Low speed lower limit
L8 = Low speed factory setting
L15 = Low speed upper limit
H1 = High speed lower limit
H8 = High speed factory setting
H15 = High speed upper limit
UH1 = Ultra-high speed lower limit
UH8 = Ultra-high speed factory setting
UH15 = Ultra-high speed upper limit

D112832

2. Measured according to JIS B 8628 - 2003.

VAM1500J

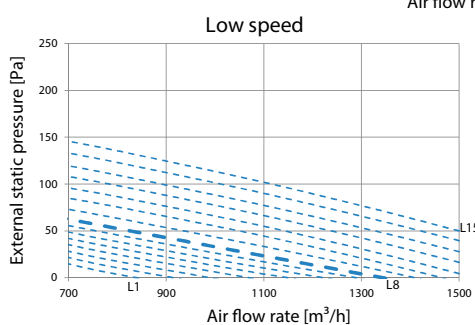
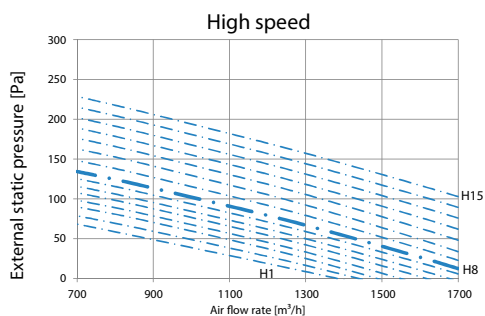
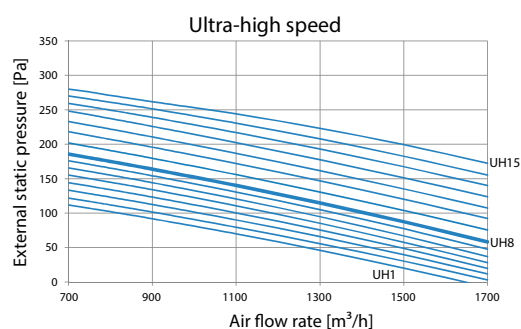
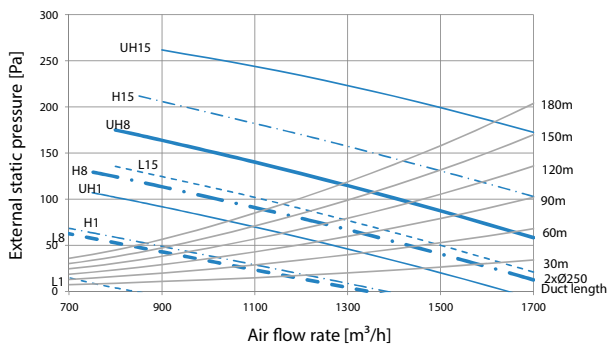

Notes

1. The fan curves are determined with $\cdot 1/3$ - of the ESP on the outdoor side (-EA & OA-), and $\cdot 2/3$ - of the ESP on the indoor side (-RA & SA).

EA = Exhaust air
OA = Outdoor air
RA = Room air
SA = Supply air

— Ultra-high speed
- - - High speed
- - - Low speed

Legend

L1 = Low speed lower limit
L8 = Low speed factory setting
L15 = Low speed upper limit
H1 = High speed lower limit
H8 = High speed factory setting
H15 = High speed upper limit
UH1 = Ultra-high speed lower limit
UH8 = Ultra-high speed factory setting
UH15 = Ultra-high speed upper limit

3D112838



VAM2000J

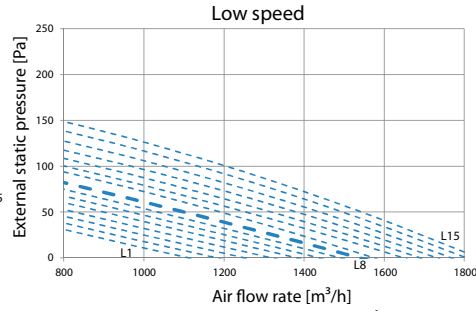
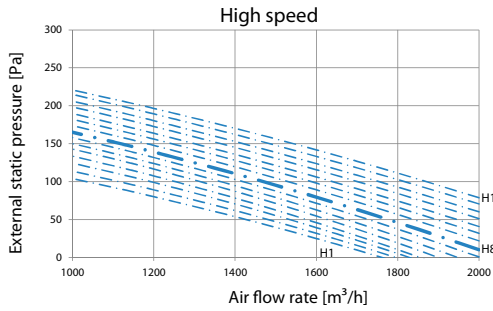
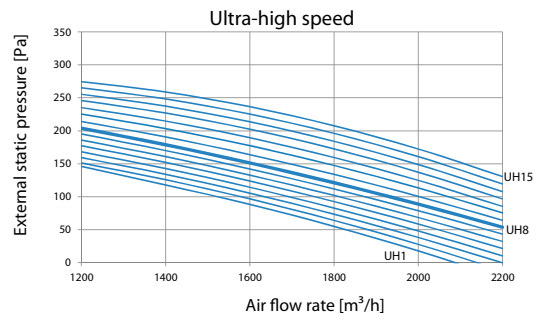
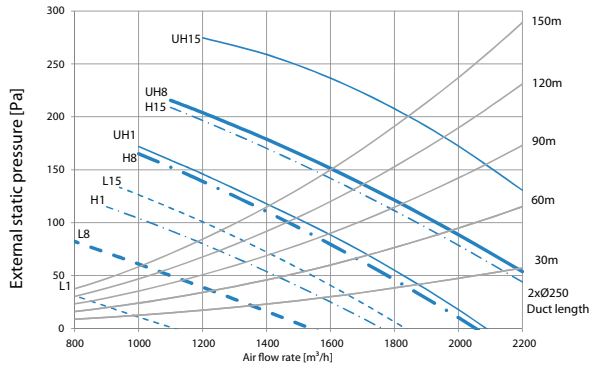

Notes

- The fan curves are determined with -1/3- of the ESP on the outdoorside (EA & OA-), and -2/3- of the ESP on the indoorside (-RA & SA-).
 EA = Exhaust air
 OA = Outdoorair
 RA = Room air
 SA = Supplyair
- Measured according to JIS B 8628 - 2003.

Legend

- L1 = Low speed lower limit
- L8 = Low speed factory setting
- L15 = Low speed upper limit
- H1 = High speed lower limit
- H8 = High speed factory setting
- H15 = High speed upper limit
- UH1 = Ultra-high speed lower limit
- UH8 = Ultra-high speed factory setting
- UH15 = Ultra-high speed upper limit

- Ultra-highspeed
- Highspeed
- Low speed

3D112839

Detailed technical drawings

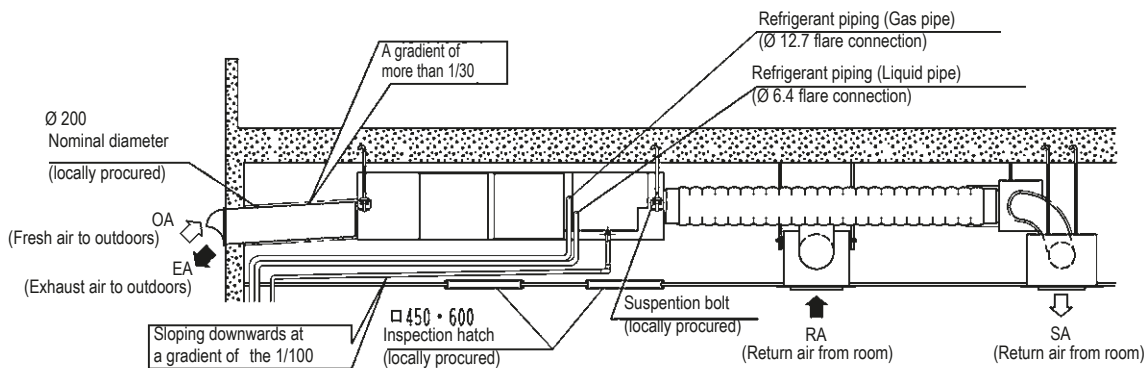
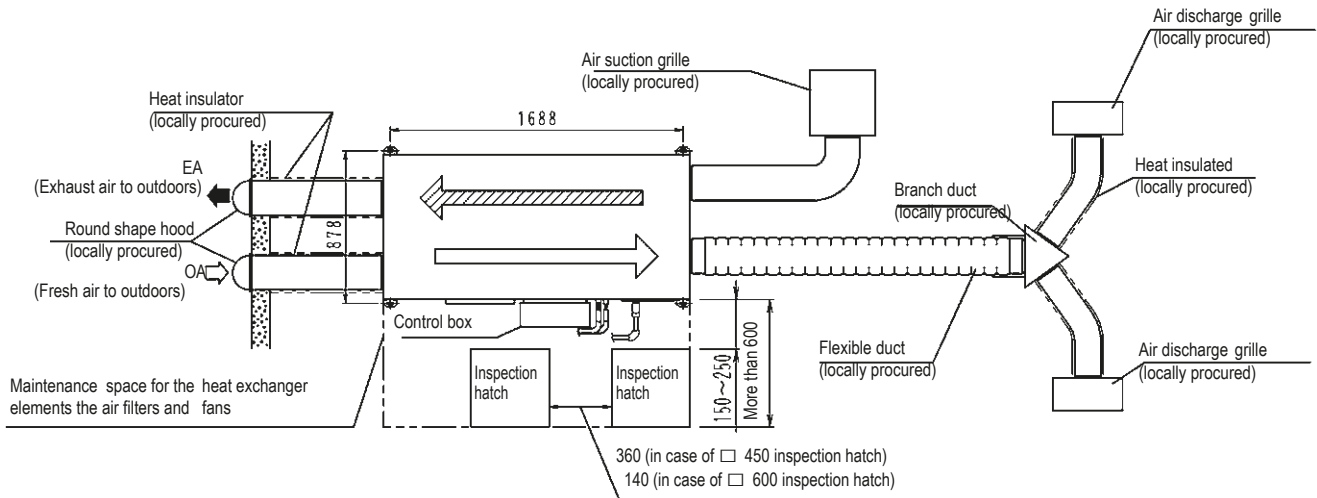
VKM50GB

NOTES

1. Leave space for servicing the unit and include inspection hatch. (Always open a hole on the side of the control box so that the air filters heat exchange elements, and fans can easily be inspected and serviced.)
2. Install the two outdoor ducts with down slope (slope of 1/30 or more) to prevent entry of rain water, also, provide insulation for three ducts (outdoor ducts and indoor supply air duct) to prevent dew condensation. (Material: glass wool of 25mm thick)
3. Do not turn the unit upside down.
4. Make sure to install drain piping, and insulate drain piping to prevent dew condensation.
5. Keep the drain pipe short and sloping downwards at a gradient of at least 1/100 to prevent air from forming.
6. Do not use a bent cap or a round hood as the outdoor hood if they might get rained on directly (we recommend using a deep hood) (optional accessory).
7. In areas where freezing may occur, always take steps to prevent the pipes from freezing.
8. Do not place something which shouldn't get wet at the below of this unit. The dew would fall at following case, where humidity is 80% more, or the exit of drain socket is choked up, or the air filter is very dirty.

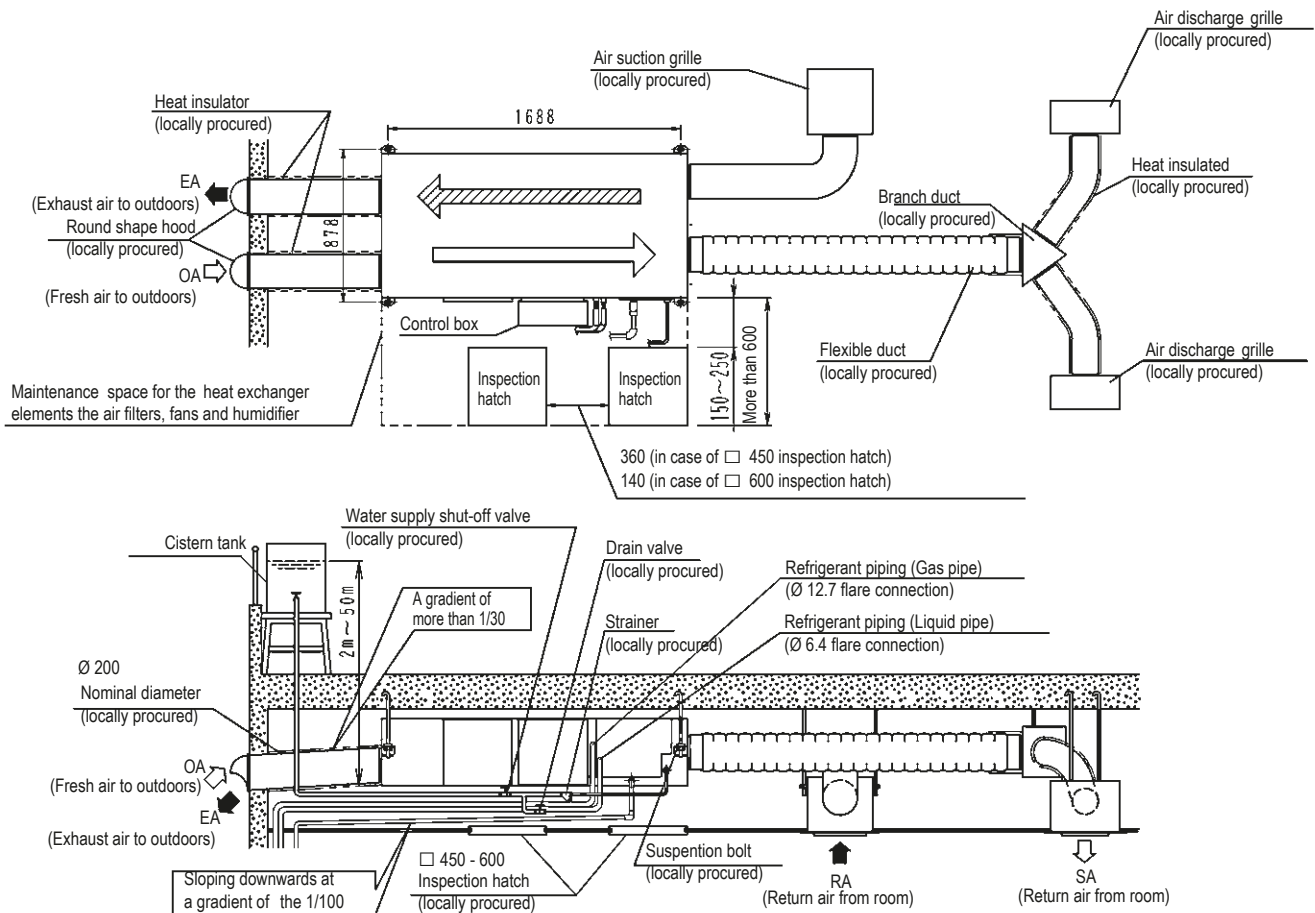
VKM50GBM



NOTES

1. Leave space for servicing the unit and include inspection hatch. (Always open a hole on the side of the control box so that the air filters heat exchange elements, and fans can easily be inspected and serviced.)
2. Install the two outdoor ducts with down slope (slope of 1/30 or more) to prevent entry of rain water, also, provide insulation for three ducts (outdoor ducts and indoor supply air duct) to prevent dew condensation. (Material: glass wool of 25mm thick)
3. Do not turn the unit upside down.
4. Use city water or clean water.
Include water supply piping with strainer, a water supply shut-off valve, and a drain valve (both locally procured) somewhere along the water supply piping that can be reached from the inspection.
5. It is impossible to connect the water supply piping directly to public piping. Use a cistern tank (of the approved type), if you need to get your water supply from public piping.
6. Make sure the supply water 0.02MPa to 0.49MPa (0.2 kg/cm² to 5 kg/cm²)
7. Make sure the supply water is between 5°C and 40°C in temperature.
8. Insulate the water supply piping to prevent condensation from forming.
9. Make sure to install drain piping, and insulate drain piping to prevent dew condensation.
10. Keep the drain pipe short and sloping downwards at a gradient of at least 1/100 to prevent air from forming.
11. Install in a location where the air around the unit or taken into the humidifier will not drop below 0°C.
12. Do not use a bent cap or a round hood as the outdoor hood if they might get rained on directly (we recommend using a deep hood) (optional accessory).
13. In areas where freezing may occur, always take steps to prevent the pipes from freezing.
14. Do not place something which shouldn't get wet at the below of this unit. The dew will fall at following case, where humidity is 80% more, or the exit of drain socket is choked up, or the air filter is very dirty.
15. Feed clean water. If the supply water is hard water, use a water softener because of short life.
Life of humidifying element is about 3 years (4,000 hours), under the supply water conditions of hardness: 150 mg/L. (Life of humidifying element is about 1 years (1500 hours), under the supply water conditions of hardness: 400 mg/L.)

Detailed technical drawings

VKM80GB

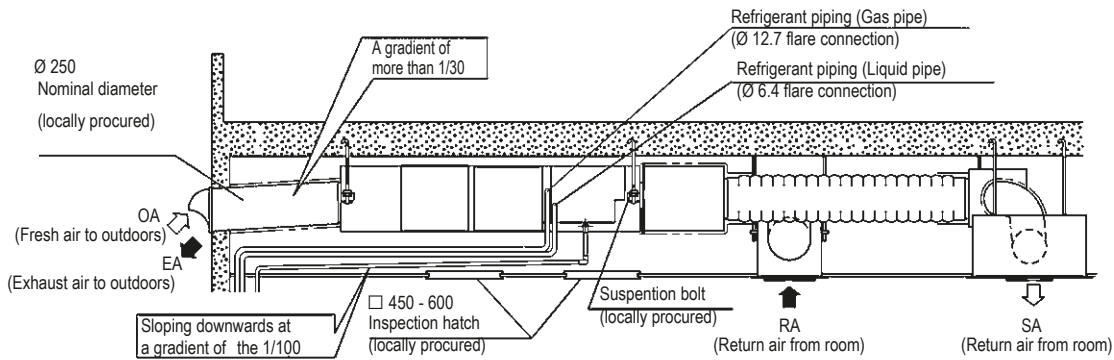
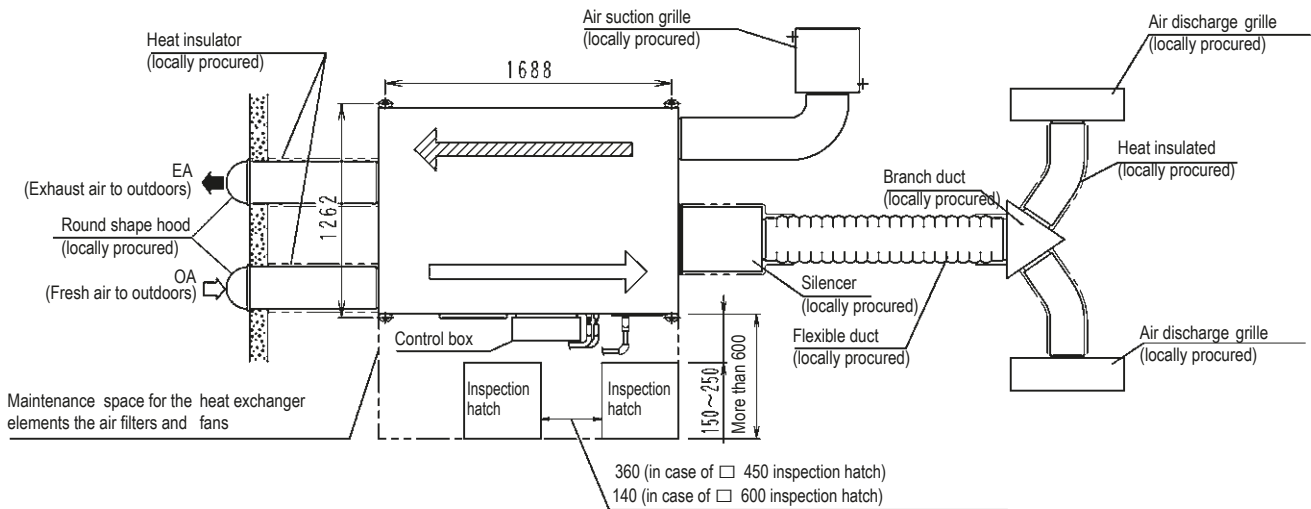

NOTES

1. Leave space for servicing the unit and include inspection hatch. (Always open a hole on the side of the control box so that the air filters heat exchange elements, and fans can easily be inspected and serviced.)
2. Install the two outdoor ducts with down slope (slope of 1/30 or more) to prevent entry of rain water, also, provide insulation for three ducts (outdoor ducts and indoor supply air duct) to prevent dew condensation. (Material: glass wool of 25mm thick)
3. Do not turn the unit upside down.
4. Make sure to install drain piping, and insulate drain piping to prevent dew condensation.
5. Keep the drain pipe short and sloping downwards at a gradient of at least 1/100 to prevent air from forming.
6. Do not use a bent cap or a round hood as the outdoor hood if they might get rained on directly (we recommend using a deep hood) (optional accessory).
7. In areas where freezing may occur, always take steps to prevent the pipes from freezing.
8. Do not place something which shouldn't get wet at the below of this unit. The dew would fall at following case, where humidity is 80% more, or the exit of drain socket is choked up, or the air filter is very dirty.

VKM80GBM

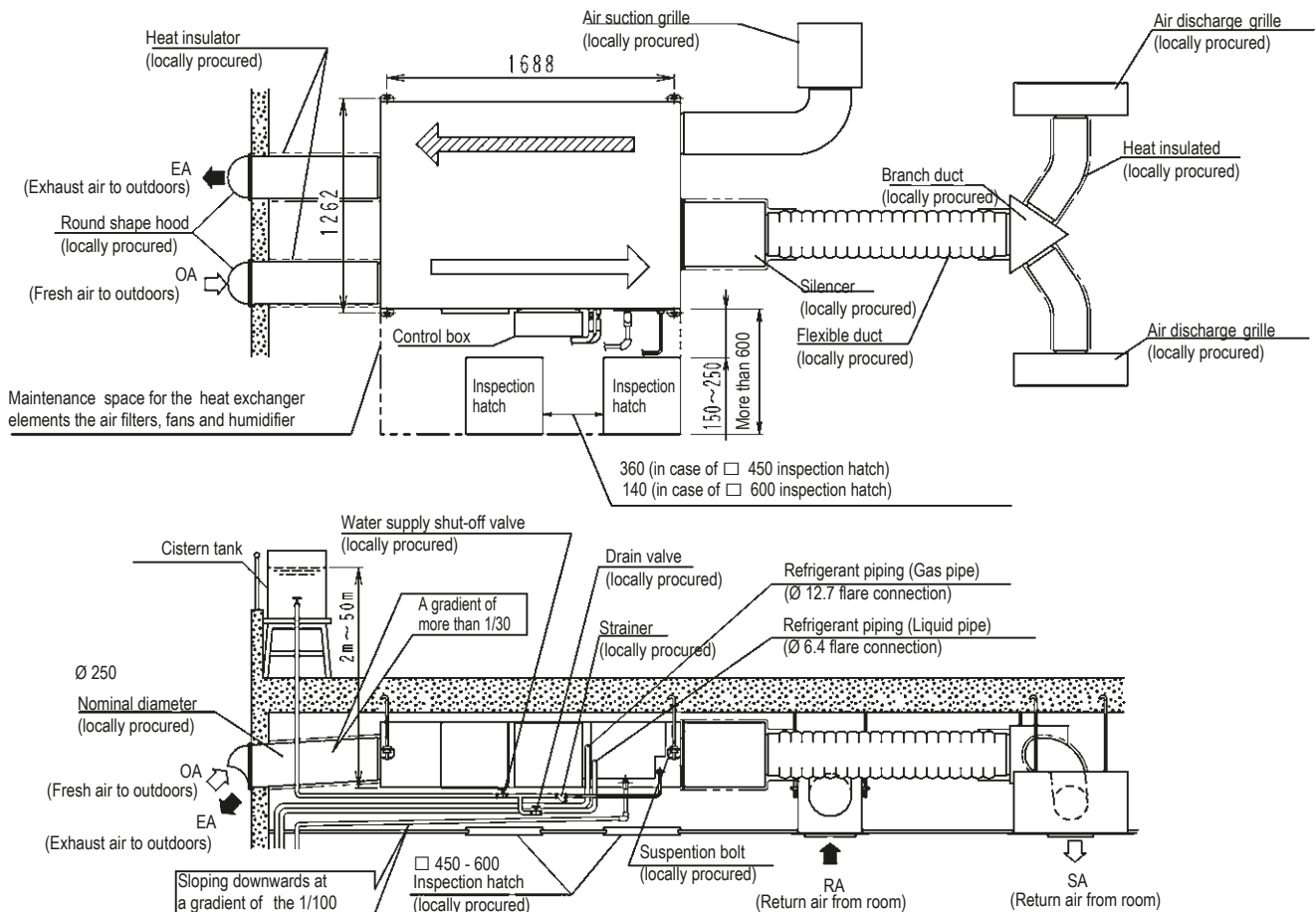

NOTES

1. Leave space for servicing the unit and include inspection hatch. (Always open a hole on the side of the control box so that the air filters heat exchange elements, and fans can easily be inspected and serviced.)
2. Install the two outdoor ducts with down slope (slope of 1/30 or more) to prevent entry of rain water, also, provide insulation for three ducts (outdoor ducts and indoor supply air duct) to prevent dew condensation. (Material: glass wool of 25mm thick)
3. Do not turn the unit upside down.
4. Use city water or clean water.
Include water supply piping with strainer, a water supply shut-off valve, and a drain valve (both locally procured) somewhere along the water supply piping that can be reached from the inspection
5. It is impossible to connect the water supply piping directly to public piping. Use a cistern tank (of the approved type), if you need to get your water supply from public piping.
6. Make sure the supply water 0.02MPa to 0.49MPa (0.2 kg/cm² to 5 kg/cm²)
7. Make sure the supply water is between 5°C and 40°C in temperature.
8. Insulate the water supply piping to prevent condensation from forming.
9. Make sure to install drain piping, and insulate drain piping to prevent dew condensation.
10. Keep the drain pipe short and sloping downwards at a gradient of at least 1/100 to prevent air from forming.
11. Install in a location where the air around the unit or taken into the humidifier will not drop below 0°C.
12. Do not use a bent cap or a round hood as the outdoor hood if they might get rained on directly (we recommend using a deep hood) (optional accessory).
13. In areas where freezing may occur, always take steps to prevent the pipes from freezing.
14. Do not place something which shouldn't get wet at the below of this unit. The dew would fall at following case, where humidity is 80% more, or the exit of drain socket is choked up, or the air filter is very dirty.
15. Feed clean water. If the supply water is hard water, use a water softener because of short life.
Life of humidifying element is about 3 years (4,000 hours), under the supply water conditions of hardness: 150 mg/L. (Life of humidifying element is about 1 years (1500 hours), under the supply water conditions of hardness: 400 mg/L.)

Detailed technical drawings

VKM100GB

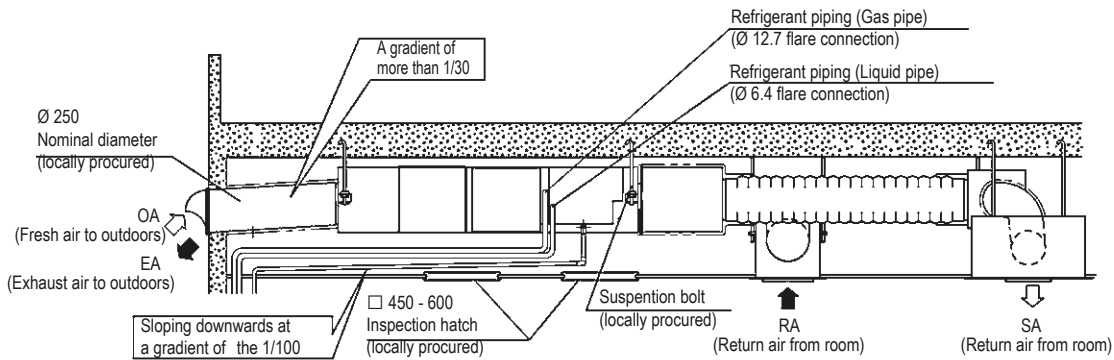
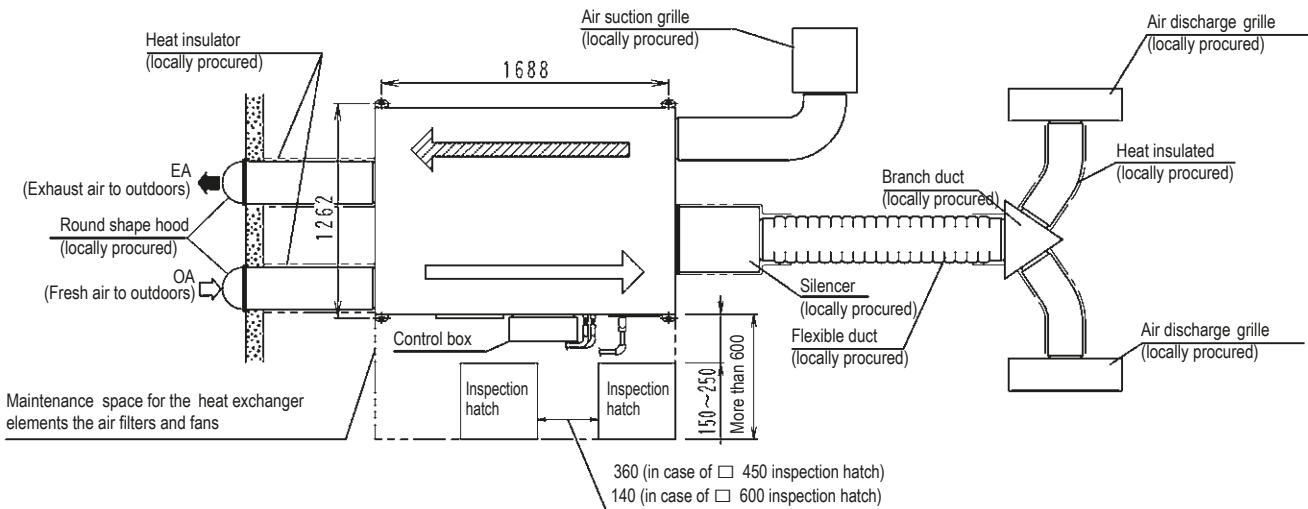

NOTES

1. Leave space for servicing the unit and include inspection hatch. (Always open a hole on the side of the control box so that the air filters heat exchange elements, and fans can easily be inspected and serviced.)
2. Install the two outdoor ducts with down slope (slope of 1/30 or more) to prevent entry of rain water, also, provide insulation for three ducts (outdoor ducts and indoor supply air duct) to prevent dew condensation. (Material: glass wool of 25mm thick)
3. Do not turn the unit upside down.
4. Make sure to install drain piping, and insulate drain piping to prevent dew condensation.
5. Keep the drain pipe short and sloping downwards at a gradient of at least 1/100 to prevent air from forming.
6. Do not use a bent cap or a round hood as the outdoor hood if they might get rained on directly (we recommend using a deep hood) (optional accessory).
7. In areas where freezing may occur, always take steps to prevent the pipes from freezing.
8. Do not place something which shouldn't get wet at the below of this unit. The dew would fall at following case, where humidity is 80% more, or the exit of drain socket is choked up, or the air filter is very dirty.



VKM100GBM

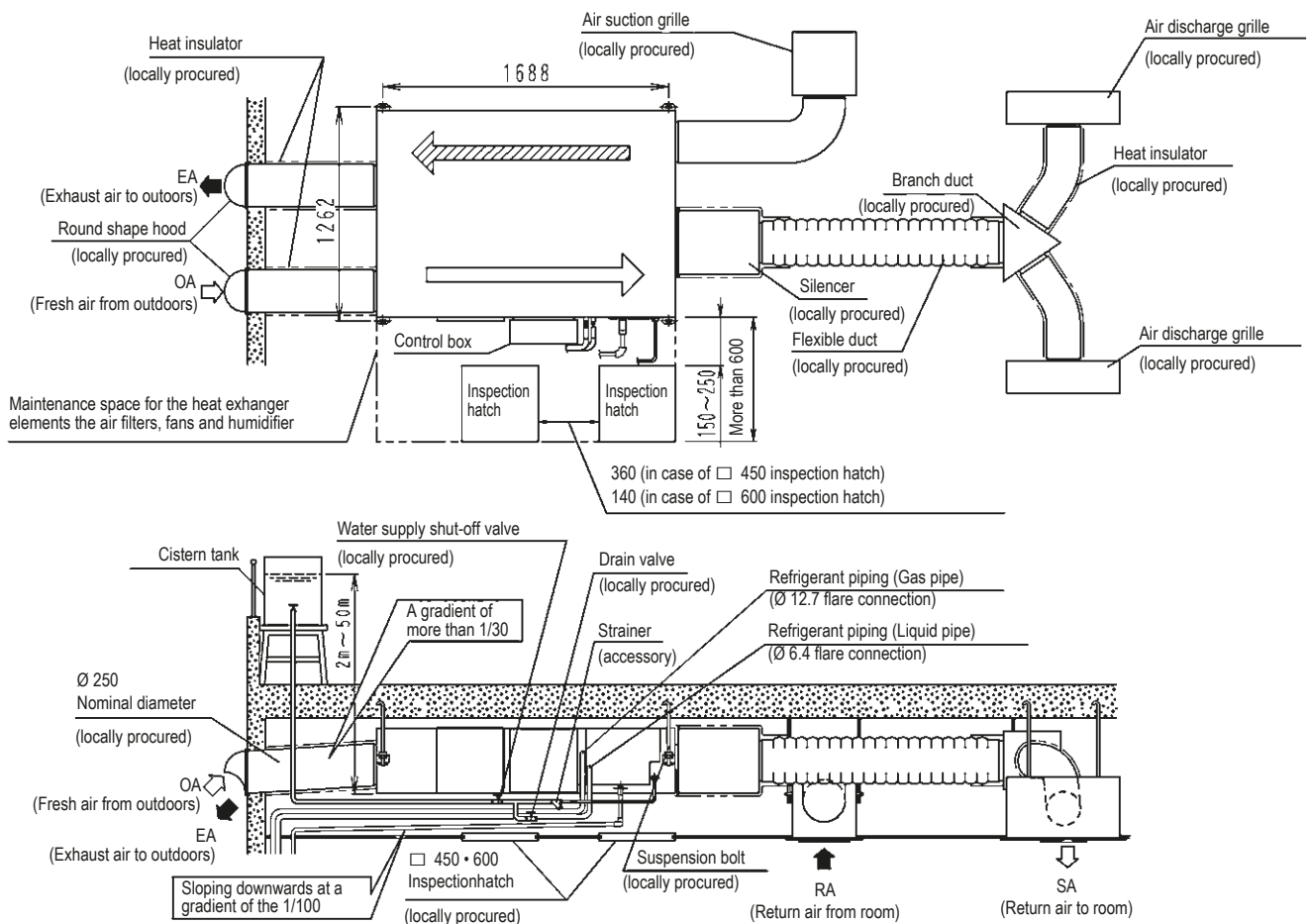

NOTES

1. Leave space for servicing the unit and include inspection hatch. (Always open a hole on the side of the control box so that the air filters, heat exchange elements, fans and humidifier elements can easily be inspected and serviced.)
2. Install the two outdoor ducts with down slope (slope of 1/30 or more) to prevent entry of rain water. Also, provide insulation for three ducts (outdoor ducts and indoor supply air duct) to prevent dew condensation. (Material: glass wool of 25mm thick)
3. Do not turn the unit upside down.
4. Use city water or clean water.
Include water supply piping with strainer, a water supply shut-off valve, and a drain valve (both locally procured) somewhere along the water supply piping that can be reached from the inspection.
5. It is impossible to connect the water supply piping directly to public piping. Use a cistern tank (of the approved type), if you need to get your water supply from public piping.
6. Make sure the supply water 0.02MPa to 0.49MPa (0.2 kg/cm² to 5 kg/cm²)
7. Make sure the supply water is between 5°C and 40°C in temperature.
8. Insulate the water supply piping to prevent condensation from forming.
9. Make sure to install drain piping, and insulate drain piping to prevent dew condensation.
10. Keep the drain pipe short and sloping downwards at a gradient of at least 1/100 to prevent air from forming.
11. Install in a location where the air around the unit or taken into the humidifier will not drop below 0°C.
12. Do not use a bent cap or a round hood as the outdoor hood if they might get rained on directly (we recommend using a deep hood) (optional accessory).
13. In areas where freezing may occur, always take steps to prevent the pipes from freezing.
14. Do not place something which shouldn't get wet at the below of this unit. The dew would fall at following case, where humidity is 80% more, or the exit of drain socket is choked up, or the air filter is very dirty.
15. Feed clean water. If the supply water is hard water, use a water softener because of short life.
Life of humidifying element is about 3 years (4,000 hours), under the supply water conditions of hardness: 150 mg/L. (Life of humidifying element is about 1 years (1500 hours), under the supply water conditions of hardness: 400 mg/L.)

Detailed technical drawings

VKM50GB

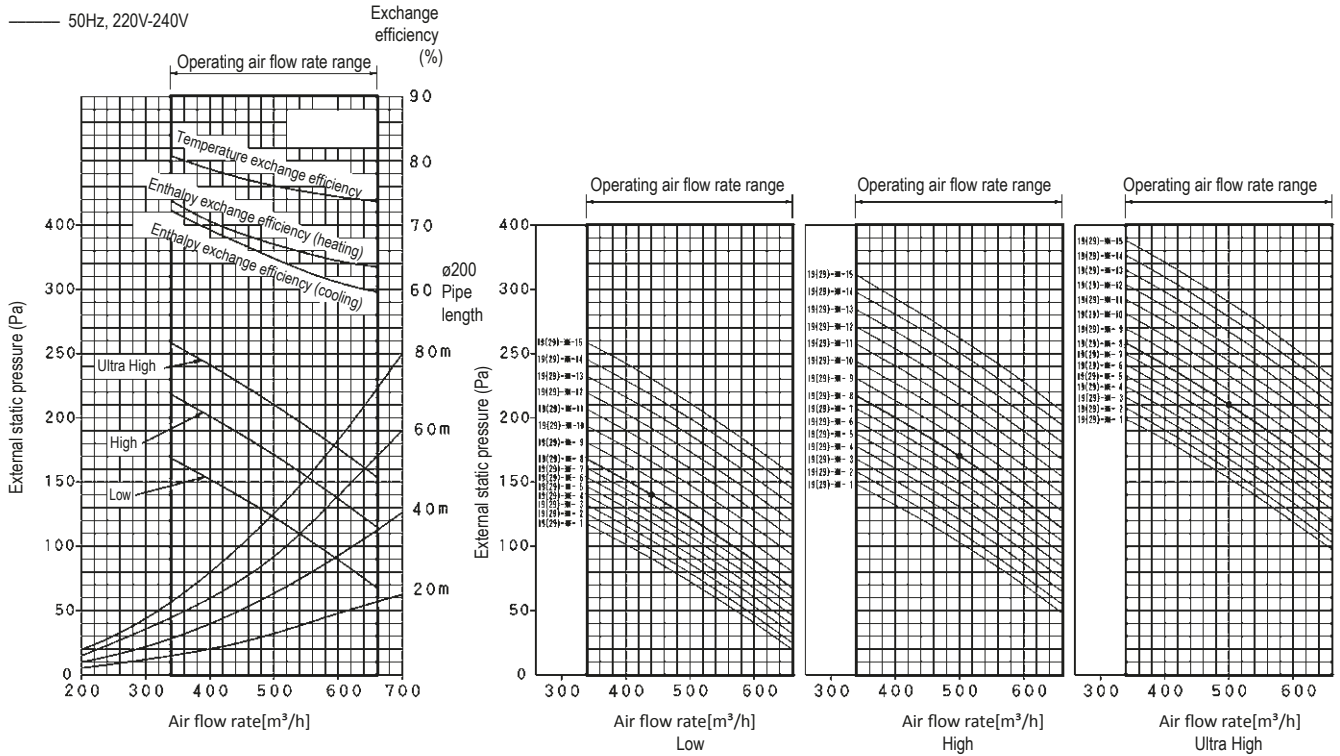

[Reading of Performance Characteristics]

- 1) For example: 19(29)-*****07
Mode no. : 19(29)
First code: ***** (Supply 「 2 」 Exhaust 「 3 」)
Second code no. : 07
- 2) Rated point: ●
- 3) The characteristic of each tap becomes a setup of the characteristic of the same code number.

3D082904

VKM50GBM

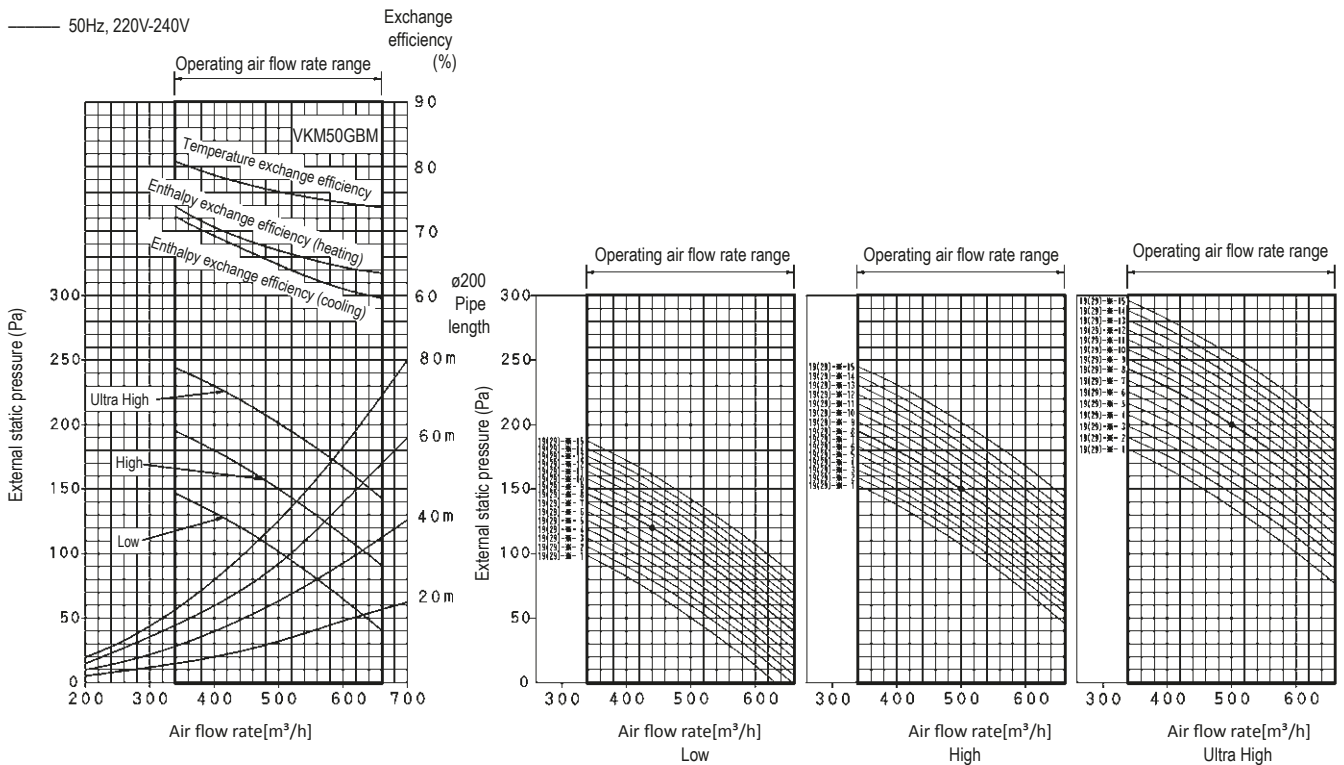

[Reading of Performance Characteristics]

- 1) For example: 19(29)-*****07
Mode no. : 19(29)
First code: ***** (Supply 「 2 」 Exhaust 「 3 」)
Second code no. : 07
- 2) Rated point: ●
- 3) The characteristic of each tap becomes a setup of the characteristic of the same code number.

3D082901



VKM80GB

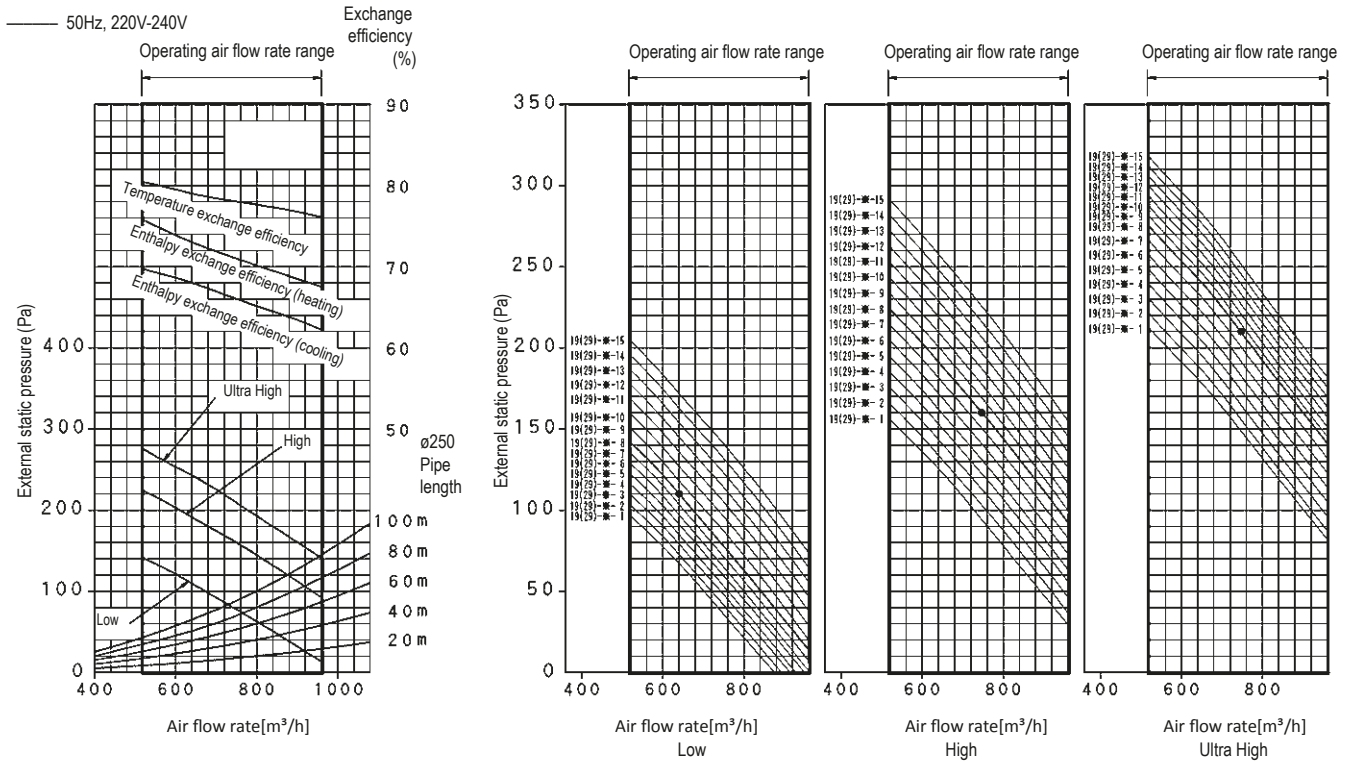

[Reading of Performance Characteristics]

- 1) For example: 19(29)-M-07
 Mode no. : 19(29)
 First code: M (Supply 「 2 」 Exhaust 「 3 」)
 Second code no. : 07
- 2) Rated point: ●
- 3) The characteristic of each tap becomes a setup of the characteristic of the same code number.

3D082905

VKM80GBM

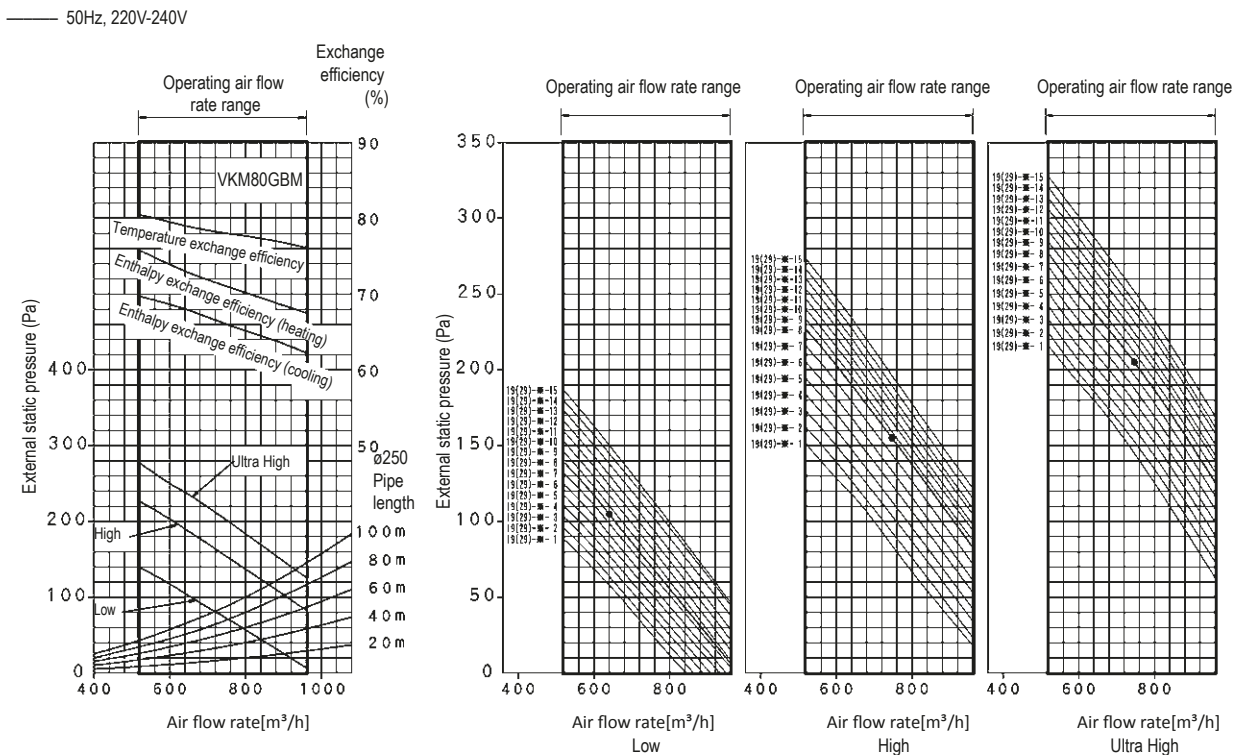

[Reading of Performance Characteristics]

- 1) For example: 19(29)-M-07
 Mode no. : 19(29)
 First code: M (Supply 「 2 」 Exhaust 「 3 」)
 Second code no. : 07
- 2) Rated point: ●
- 3) The characteristic of each tap becomes a setup of the characteristic of the same code number.

3D082902

Detailed technical drawings

VKM100GB

— 50Hz, 220V-240V

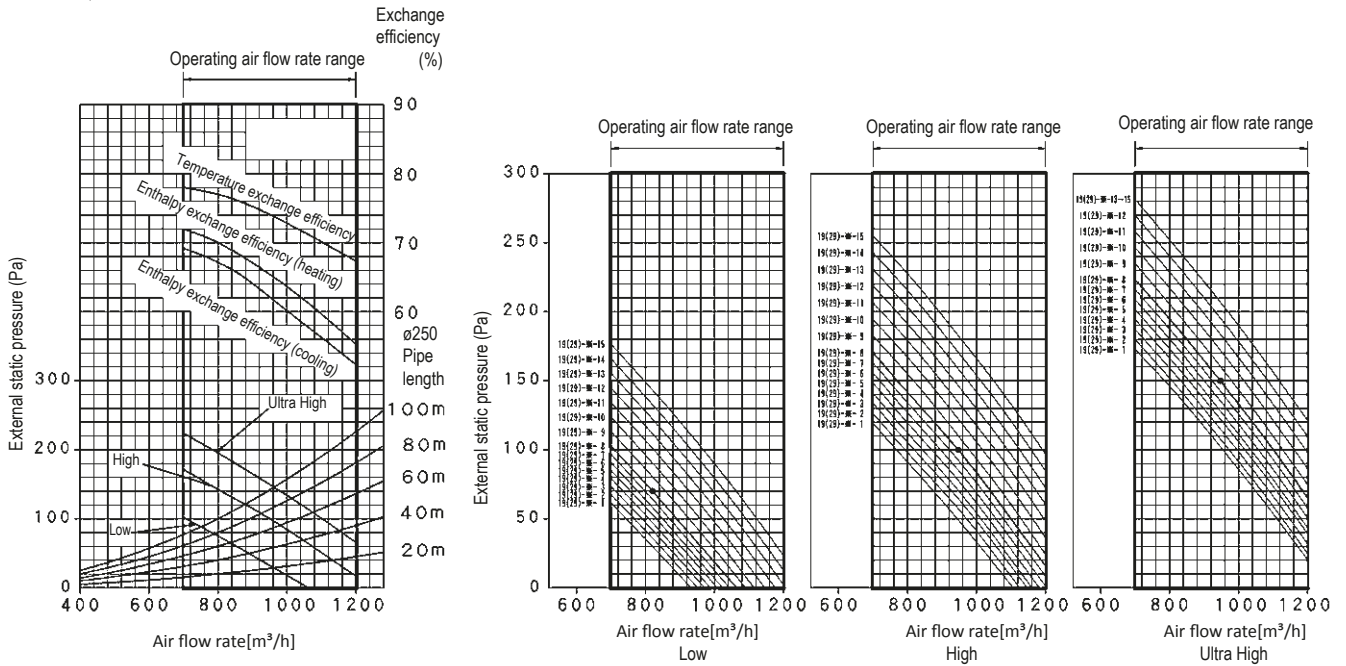

[Reading of Performance Characteristics]

1) For example: 19(29)-*07

Mode no. : 19(29)
 First code : * (Supply 「 2 」 Exhaust 「 3 」)
 Second code no. : 07

2) Rated point: ●

3) The characteristic of each tap becomes a setup of the characteristic of the same code number.

3D082906

VKM100GBM

— 50Hz, 220V-240V

Exchange efficiency (%)

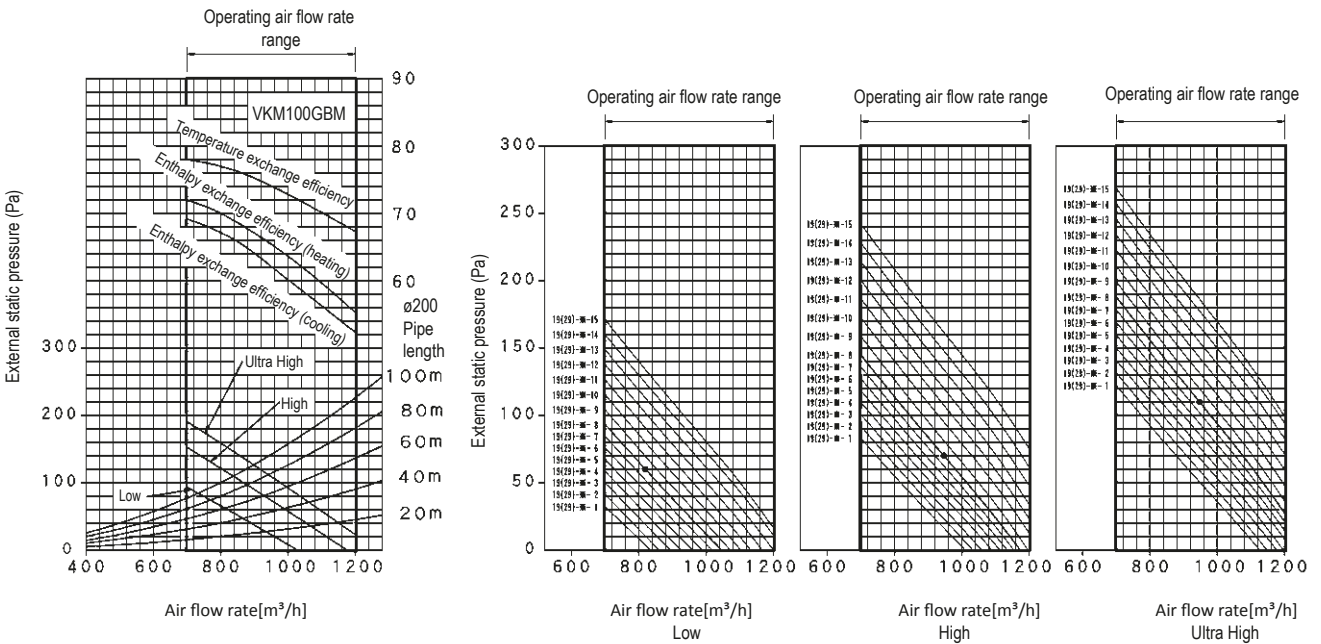

[Reading of Performance Characteristics]

1) For example: 19(29)-*07

Mode no. : 19(29)
 First code : * (Supply 「 2 」 Exhaust 「 3 」)
 Second code no. : 07

2) Rated point: ●

3) The characteristic of each tap becomes a setup of the characteristic of the same code number.

3D082903

Premium efficiency heat recovery unit Modular L Smart



Premium quality to meet the most demanding needs

- › Best possible Indoor Air Quality thanks to optional pre-filters from Coarse 55% (G4) up to ePM1 50% (F7) and second step filtration up to ePM1 80% (F9)
- › Plug & Play connectable to Sky Air and VRV for integrated control
- › High efficiency aluminium counter flow heat exchanger (up to 93%)
- › Maximum ESP available up to 600 Pa
- › Air flow from 150 up to 3,450 m³/h
- › Optional CO₂ sensor saves energy while improving indoor air quality
- › Optional factory tested heater available to extend operation range
- › Low sound level
- › 6 standard sizes available from stock



Daikin Europe N.V. Naamloze Vennootschap Zandvoordestraat 300 · 8400 Oostende · Belgium · www.daikin.eu · BE 0412 120 336 · RPR Oostende (Publisher)

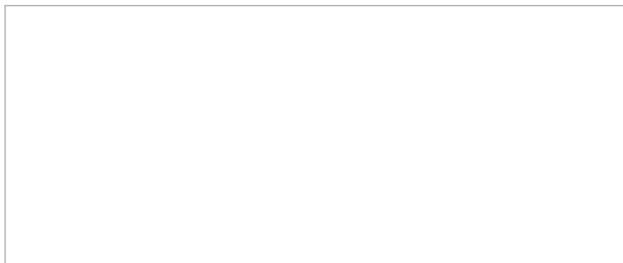

ECPEN20-203

11/19



The present publication is drawn up by way of information only and does not constitute an offer binding upon Daikin Europe N.V. Daikin Europe N.V. has compiled the content of this publication to the best of its knowledge. No express or implied warranty is given for the completeness, accuracy, reliability or fitness for particular purpose of its content and the products and services presented therein. Specifications are subject to change without prior notice. Daikin Europe N.V. explicitly rejects any liability for any direct or indirect damage, in the broadest sense, arising from or related to the use and/or interpretation of this publication. All content is copyrighted by Daikin Europe N.V.

Printed on non-chlorinated paper.